

Retail Stock Movement Trolley

LIFTEX



- Stackable trolley with a self leveling top shelf which dramatically reduces back injuries and strain as the load automatically increases in height as items are lifted off and lowers as items are loaded.
- The top shelf is self levelling at 0-250kg.
- At 200kg the top shelf will be at the lowest position which is 290mm above the bottom shelf allowing for empty crates to be stored underneath
- Internal Platform Size: 1200mm long x 585mm wide
- Overall Height: 1052mm
- Handle Height: 995mm
- Overall Width: 675mm
- Overall Length: 1525mm
- Bottom Platform Height: 200mm
- Top Platform Height: 890mm (highest position)
- Top Platform Height: 485mm (lowest position)
- Overall Load Capacity 400kg
- 4 x elastic rubber castor swivel castors diameter 125mm and 2 fixed centre wheels which allow for turning within its own length.
- Optional spring operated press foot floor brake
- Handles at both ends
- Unit Weight: 89kg



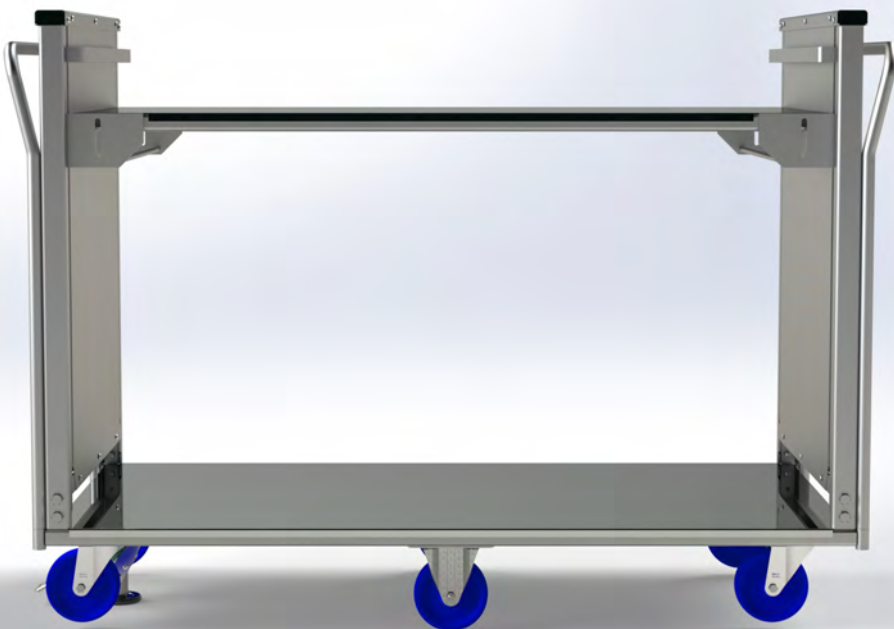



Product Code: LT2047CL



Foot press brake

 **Sydney** (02) 8865 1800
 nsw@mhaproducts.com.au

 **Melbourne** (03) 9115 9100
 vic@mhaproducts.com.au

 **Brisbane** (07) 3181 5630
 qld@mhaproducts.com.au

Operational Video Here



MHA
PRODUCTS

Retail Stock Movement Trolley



LIFTEX







Clear vision

Trolley is shown to scale loaded with the large RFC crates 578x385x210mm with 15 on the top shelf and 3 on the bottom shelf



 **Sydney** (02) 8865 1800
 nsw@mhaproducts.com.au

 **Melbourne** (03) 9115 9100
 vic@mhaproducts.com.au

 **Brisbane** (07) 3181 5630
 qld@mhaproducts.com.au

Operational Video Here



MHA
PRODUCTS



Retail Stock Movement Trolley

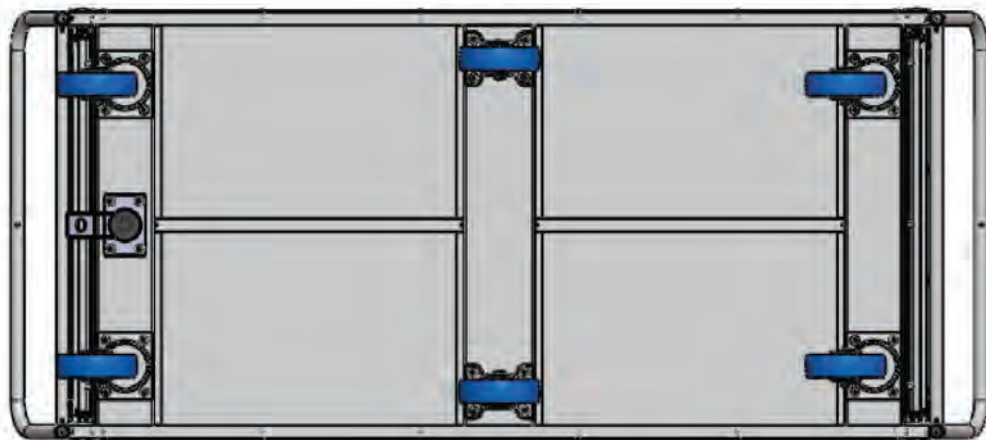

LIFTEX





The Liftext self levelling trolley is designed so that the castors are mounted inside the base frame so that they can't be damaged from other trolleys or from fixed objects



 **Sydney** (02) 8865 1800
 nsw@mhaproducts.com.au

 **Melbourne** (03) 9115 9100
 vic@mhaproducts.com.au

 **Brisbane** (07) 3181 5630
 qld@mhaproducts.com.au

MHA
PRODUCTS

Retail Stock Movement Trolley

LIFTEX

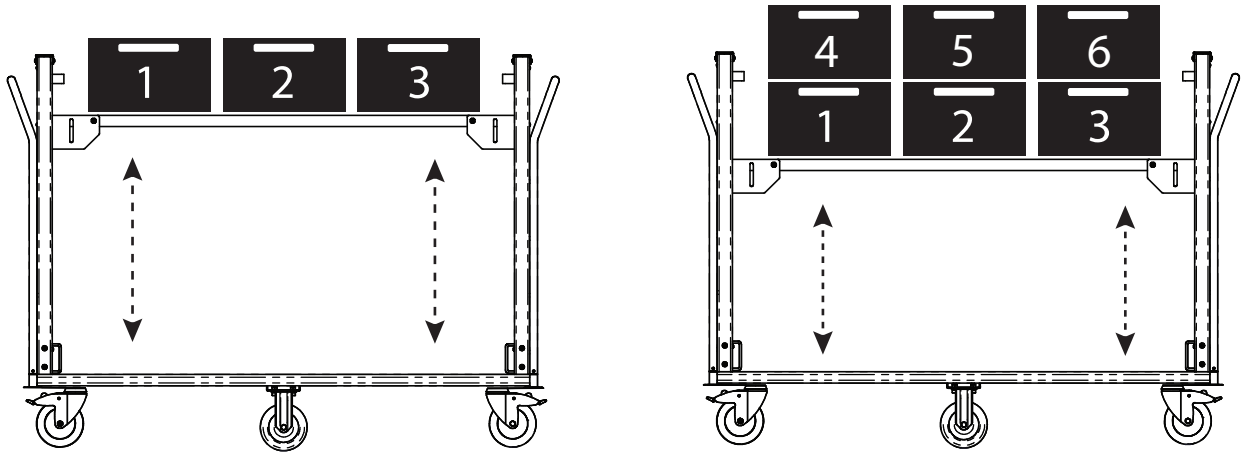

As loading begins the platform will automatically lower and raise as its loaded/unloaded

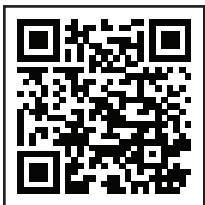
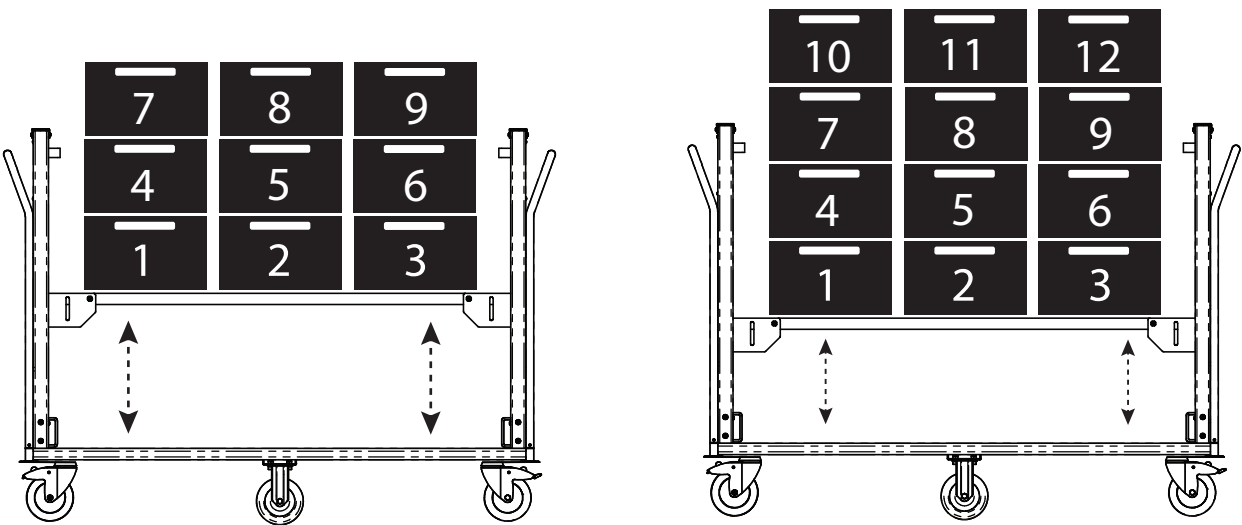

View Operational Video Here,
www.mhaproducts.com.au/LT2047

Sydney (02) 8865 1800
✉ nsw@mhaproducts.com.au

Melbourne (03) 9115 9100
✉ vic@mhaproducts.com.au

Brisbane (07) 3181 5630
✉ qld@mhaproducts.com.au

MHA
PRODUCTS