

Rubbermaid

Commercial Products

1800 750 900



CLEANING | UTILITY AND RECYCLING REFUSE | DECORATIVE REFUSE
MATERIAL HANDLING | SAFETY | FOODSERVICE | WASHROOM

PRODUCTIVE SOLUTIONS FOR ANY CLEANING NEED



From healthcare facilities, office buildings, and restaurants to schools, only Rubbermaid Commercial Products delivers the broadest line of cleaning systems to ensure every environment is healthy and safe. For optimal productivity and innovative solutions, contact your Rubbermaid representative today or visit us online.



HYGEN™

Work Smarter.

Washroom

Air Care Selection Guide	7
Air Care Aerosol	7
Air Care Nonaerosol	14
Counter Mount Touch-Free and Manual Skin Care	18
Wall-Mount Touch-Free Skin Care	20
Wall-Mount Manual Skin Care	22
Industrial Wall-Mount Skin Care	26
Fixtures and Hardware.....	27
Water Conservation.....	32
Surface Care	33
Washroom Accessories	37

Cleaning

Rubbermaid HYGEN™ Microfiber Cleaning	45
Standard Microfiber Cleaning	56
Dusting Tools.....	58
WaveBrake® Mopping Systems	60
Wet Mops.....	64
Wet Mop Handles and Accessories	75
Mopping Accessories.....	77
Dust Mops.....	78
Carpet Bonnets.....	85
Brooms and Brushes.....	86
Scrub Brushes and Squeegees	92
Dust Pans	94
Cleaning Carts	95
Vacuums.....	110
Sweepers.....	118
Tools and Accessories	120

Utility and Recycling Refuse

BRUTE® Utility and Recycling	127
Indoor Utility and Step-Ons	134
Indoor Utility and Confidential Waste	147
Additional Recycling Options	148
Rigid Liners.....	150
Can Liners.....	151

Decorative Refuse

Indoor Containers.....	154
Outdoor Containers	178
Smoking Management.....	197
Planters	203
Linens	204

Material Handling

Platform Trucks	208
Workstations	219
Utility and Service Carts.....	222
Shelving and Audio-Visual Carts	228
Bulk Trucks	231
Storage.....	236
Farm and Garden.....	237

Safety

Barriers and Safety Signs	242
Safety Cones.....	244
Safety Signs and Over-The-Spill® System	246

Foodservice

Food Storage	250
Food Preparation	260
Monitoring Solutions	263
Food Transport.....	272
Beverage and Table Service	280
Youth Service.....	282

Common Conversions

Color Guide

Accessories

Custom Options

Index

Products	292
Components	314



Certifications



BS EN ISO 9001:2008/Winchester, VA

3124 Valley Avenue
Winchester, Virginia 22601, USA
Certificate Number FM 531871

BS EN ISO 9001/Cleveland, TN

2000 Overhead Bridge Road
Cleveland, Tennessee 37312, USA
Certificate Number FM 33122

Rubbermaid Commercial Products LLC operates a quality management system which complies with the requirements listed above.

ISO

ISO is an internationally recognized quality management system that provides:

- Guidance for businesses that want to implement or improve quality systems within their business
- Benchmarks that customers can use to evaluate a supplier's quality system

ISO Certification of the Commercial Products Facilities perfectly embodies Rubbermaid principles:

- ISO certification represents a commitment to continuous value improvement; rather than look at particular products, ISO reviews the systems and procedures through which businesses assure quality products
- ISO certification shows that a company has built a culture of quality
- ISO certification demonstrates a commitment to world class quality systems and the global marketplace

ISTA

International Safe Transit Association. The Compacted Mops were tested and certified via ISTA Test Procedures.

FDA

Food and Drug Administration does not approve products. The FDA sets regulations which require compliance.

NSF Registration Guidelines for Proprietary Substances and Nonfood Compounds:

Handwashing and sanitizing products (Category Code E2): Combination of detergents-germicides (single step preparations designed to combine hand washing and sanitizing) will be considered for registration on the basis of their ability to effectively clean the hands as well as their germicidal equivalency to 50 ppm available chlorine. The hands need not be washed with soap or detergent prior to the use of such preparations. However, the hands must be rinsed with potable water after the use of the product and before handling food.

Hand sanitizing products (Category Code E3): Products manufactured from those solutions described in CFR Title 21, Section 178.1010, which are applicable for the purpose may be used to sanitize the hands of employees handling food products without a subsequent rinse provided they are germicidally equivalent to 50 ppm available chlorine. Products shall not contain perfumes leaving a residual odor on hands after usage. These sanitizing solutions may be used only after thoroughly washing hands with soap or detergent and water, followed by rinsing with potable water. In many instances, these hand sanitizers may be injected directly into wash/rinse water.

ASTM

ASTM F-404-08 is an American Society for Testing and Materials' safety standard for evaluating a High Chair. A "test dummy" that simulates a child of predetermined size is strapped into the chair and various push, pulls, and racking tests are conducted on the chair and also using the dummy to simulate forces required to remove dummy, and to determine the safety aspects of ensuring proper confinement within the chair without causing harm to the child.

ASTM F-2285-04 is an American Society for Testing and Materials' safety performance specification that establishes performance requirements, test methods, and labeling requirements to minimize the hazards to children presented by Diaper Changing Tables for commercial use with children up to 50 lbs.

ASTM 615 is an American Society for Testing and Materials standard specification for Deformed and Plain Carbon Steel. This specification covers deformed and plain carbon steel bars for concrete reinforcement in cut lengths and coils.

ASTM C150-07 is an ASTM standard specification for Portland Cement, specifically Portland Cement Type 1, for use when the special properties specified for any other type are not required, and Portland Cement Type III, for use when high early strength is desired.



ADA

- The Americans with Disabilities Act prohibits discrimination and ensures equal opportunity for persons with disabilities in employment, state and local government services, public accommodations, commercial facilities, and transportation
- Rubbermaid Commercial Products refuse containers need to comply with the ADA regulation; as long as "access openings" for containers are below 48", containers are compliant to ADA regulations
- All Decorative Waste products comply with ADA Reach Range Requirements, except for step can models; all Decorative Waste wall mount models comply with ADA Reach Range Requirements, dependant upon height placement within the mandated "Reach Range"



ADA COMPLIANT

CE

The CE marking (an acronym for the French "Conformite Europeenne") certifies that a product has met EU health, safety, and environmental requirements, which ensure consumer safety. Manufacturers in the European Union (EU) and abroad must meet CE marking requirements where applicable in order to market their products in Europe.



CSFM

California State Fire Marshal listing is obtained for various types of containers once tested (by independent testing laboratories) against specific criteria. Following our receipt of UL and/or FM approval for those items, the results were submitted/accepted by California. The State of California is generally regarded to have the most stringent fire codes of all the United States. For an annual fee (every June 30th) the CSFM listings are updated.

Decorative Waste products that are UL Listed/FM Approved Fire-Safe/Self-Extinguishing and UL Classified are listed by the California State Fire Marshal pursuant to section 13144.1 of the California Health and Safety Code. See CSFM Listing No. 4480-1025:100.

CSFM

FM

Factory Mutual is an independent testing agency whose approvals are based on Standard 6921 Combustible Waste Containers. Standard 6921 is performance criteria for containers with covers (lids) and their ability to withstand internal fires, maintain a certain range of stability, if dumped, and stay intact over a wide temperature range. Standard 6920 is performance criteria for Oily Waste Containers.



GREEN SEAL™

This product meets the Green Seal™ standard for institutional hand cleaners based on its reduced human and aquatic toxicity and reduced smog production potential.



HACCP

Hazard Analysis and Critical Control Points is a systematic method using principles (Food Hygiene Practices) for analyzing a food process and determining the possible chemical, physical, and biological hazards within that process that should prevent any unsafe food from leaving the process (this process could be for a food processing plant or food preparation in a restaurant). The seven principles are: 1. Application, 2. HACCP Plan Validation, 3. Quality Manual Review, 4. On-site Readiness Review, 5. Registration Audit, 6. Registration, and, 7. Surveillance

JOINT COMMISSION

The Joint Commission (formerly known as JCAHO) evaluates and accredits nearly 15,000 health care organizations and programs in the U.S. Joint Commission standards address the organization's level of performance in key functional areas, such as patient rights, patient treatment, and infection control.

USGBC

As a member of the United States Green Building Council, we are dedicated to promoting products for buildings that are environmentally responsible and healthy places to work. We offer over 1,000 products that contribute to buildings achieving LEED Certification. Visit www.rubbermaidcommercial.com for more information on USGBC and LEED Certification.



NFPA

Our Steel and Aluminum products comply with the National Fire Protection Association, Life Safety Code #101, section #31, which states wastebaskets and other waste containers shall be noncombustible.



NSF

National Sanitation Foundation is an independent testing lab/organization in Ann Arbor, Michigan. NSF lists products which meet their criteria for cleanliness and sanitation: food contact, splash zone and non-food contact, per Standard 2: Food Equipment and Standard 18: Manual Beverage Dispensers. NSF 3-A USDA for equipment used in processing meat and poultry products. Also, Standard 21: Thermoplastic Refuse Containers.



EU

Regulation (EC) No 1935/2004 of the European Parliament and of the council on materials and articles intended to come into contact with food: The purpose of this European Union Regulation is to ensure that materials and articles intended to come into contact directly or indirectly with food are safe in design and construction to protect the health of consumers.



OBRA

All UL Listed/ FM Approved Fire-Safe/Self-Extinguishing steel receptacles comply with the following Omnibus Budget Reconciliation Act of 1990 Nursing Home Reform Legislation regulations:

- Quality of Life-483.15(h)(1) Environment
- Dietary Service-483.35(h)(3) Disposal of Garbage and Refuse
- Infection Control-483.65(a) Infection Control Program (c) Storage of Linen
- Physical Environment-483.70(a) Life Safety From Fire (g)(2) Smoking Areas

OSHA

- Decorative Waste products comply with Occupational Safety and Health Administration (OSHA) Standard for Occupational Safety and Health Part 1910.141 Sanitation
- Defenders® Step Cans and Medi-Cans™ comply with OSHA Standard for Bloodborne Pathogens, Final Rule 29CFR, Part 1910.1030

UL

Underwriters Laboratory. The UL Classified baskets (FG254000, FG254100, FG254200, FG254300, FG254400) meet the criteria for UL Standard 242 which is a standard of performance for open top, non-metallic wastepaper containers. UL classified baskets are generally found in use in patient care rooms (hospitals/nursing homes).

Decorative Waste products that are UL Classified have been tested and approved only to burning paper containment and resistance to temperature rise of surrounding surfaces.

Decorative Waste products that are UL Listed / FM Approved/Fire-Safe/Self-Extinguishing have been tested and approved for the fire-safe containment of dry flammable paper waste products.



Legend



Assembly required



Hands-free products that help reduce the risk of cross-contamination



UV stabilizer added for maximum life in outdoor settings



Medical Waste Approved



Custom Decals



Retail Friendly Packaging

Indicates product is suitable for medical waste

Custom decal options are available for this product

Product is packaged for sale in a retail environment



Indicates products that contribute to Green Cleaning and Sustainability



Indicates new Executive Series™ Product



Product has antimicrobial properties

Product

- Products and components are subject to change without notice, and may differ from catalog imagery
- Certain products listed in this catalog may not be available to all distributors; please call RCP Customer Service at (800) 347-9800 for instructions on how to purchase



WASHROOM SOLUTIONS



Washroom Solutions from Rubbermaid offers a broad range of hygienic and touch-free products with superior formulations and dependable dispensing systems for Air Care, Skin Care, Surface Care, and automated Faucet and Flushing Systems.

You can count on reliable, cost-effective Washroom Solutions that preserve the environment, protect the users, and strengthen your business.



AIR CARE

AIR CARE AEROSOL

Air Care Selection Guide	8
Microburst® Duet	9
Microburst® Duet Refills	9
Microburst® 3000 and 9000	10
Microburst® 3000 and 9000 Refills	11
Standard Aerosol System	12
Standard Aerosol System Refills	12
SeBreeze® Aerosol Programmable Plus™	
Odor Neutralizing Unit	13
Economy SeBreeze® Aerosol	
Odor Neutralizing Unit	13
SeBreeze® Series Refills	13

AIR CARE NONAEROSOL

TCell™ Odor Control System	14
TCell™ Refills	15
SeBreeze® Adjustable Fan Dispenser	16
SeBreeze® Portable Fan System	16
Rubbermaid® Fragrance Cassette®	
with Odor-Absorbing Gel	16
Gel Odor Control System	17
Pump Odor Control System	17

SKIN CARE

COUNTER-MOUNT TOUCH-FREE AND MANUAL SKIN CARE

One Shot® Touch-Free Soap System	18
Enriched Foam Refills (for use with	
One Shot® Foam Dispensers)	18
Manual Soap System	19
Enriched Lotion Refills (for use with One Shot®	
and Manual Liquid Dispensers)	19

WALL-MOUNT TOUCH-FREE SKIN CARE

Auto Foam Touch-Free Skin Care System	20
Enriched Foam Refills	
(for use with Auto Foam Dispensers)	21
Auto Foam Starter Kits and	
Sanitizing Station	21

WALL-MOUNT MANUAL SKIN CARE

Rubbermaid Flex™ Manual Skin	
Care System	22
Enriched Foam Refills (for use with	
Rubbermaid Flex™ Dispensers)	23
Enriched Lotion Refills (for use with	
Rubbermaid Flex™ Dispensers)	23
Foam Skin Care System	24
Spray Skin Care System	25
Spray Hand Sanitizer System	25

INDUSTRIAL WALL-MOUNT SKIN CARE

ProRx™ Skin Care System	26
Enriched Lotion Refills	
(for use with ProRx™ Dispensers)	26

FIXTURES AND HARDWARE

Auto Faucet®	27
Auto Flush® Systems	28
Auto Flush® Sidemount	30
Auto Flush® Clamp	31
Auto Flush® Tank	31

WATER CONSERVATION

ecoUrinal™	32
------------------	----

SURFACE CARE

SaniCell™	33
SaniCell™ Pipe	33
SaniCell™ Tank	33
SaniCell™ Wall	34
Purinel® SC Refills	34
AutoClean®	35
AutoJanitor®	36
Clean Seat	36

WASHROOM ACCESSORIES

Auto Door™	37
Sanitary Bins	38
Sanitary Napkin Receptacles	38
Baby Changing Stations	39
Safty-Grip® Bath and Shower Mats	39



WASHROOMSOLUTIONS



Spa Collection

Naturally Improving Health & Wellness



Introducing three clean, natural fragrances designed to rejuvenate mind and body while neutralizing odors in any environment.

- These fragrances are infused with therapeutic ingredients and essential oils proven to have a positive impact on mood
- Each blended fragrance offers complex, multidimensional scents proven to disperse evenly and last longer
- Available for TCell™, Microburst® Duet, Microburst® 3000, Microburst® 9000, and Standard Aerosol systems



Purifying Spa

Floral Aromas Promote Clarity and Boost Concentration



Relaxing Spa

Herbal Notes Calm and Soothe the Senses



Energizing Spa

Citrus Blends Recharge and Invigorate the Mind

Innovative Air Care Solutions

Selecting the optimal air care system for your facility.
Use the guide below to determine the best air care solution for your location.



MICROBURST® DUET

Aerosol Odor-Control System

- Dual fragrance capability
- Flexible LCD programming means you decide which fragrance will spray, and when



MICROBURST® 3000 & 9000

Aerosol Odor-Control System

- Single fragrance capability
- Flexible programming means you decide which fragrance will spray, and when
- Refill indicator shows days remaining before refills need to be changed



STANDARD AEROSOL SYSTEM

Aerosol Odor-Control System

- Single fragrance capability
- Smart Chip technology maximizes odor control effectiveness
- LCD and LED models feature adjustable spray intervals



OTHER AEROSOL SYSTEMS

Aerosol Odor-Control System

- SeBreeze® Aerosol Programmable Plus™
- Economy SeBreeze® Aerosol



TCELL™

Nonaerosol Odor-Control System

- ONLY passive system delivering consistent odor control over 60 or 90 days
- Easy-to-use system requires no programming



OTHER NONAEROSOL SYSTEMS

Nonaerosol Odor-Control System

- Gel Odor Control System
- Pump Odor Control System
- SeBreeze® Adjustable Fan Dispenser
- SeBreeze® Portable Fan System

DISPENSER SELECTION GUIDE

	Microburst® Duet	MicroBurst® 3000	MicroBurst® 9000	Standard Aerosol	SeBreeze® Programmable Plus™	SeBreeze® Economy	TCell™	Gel Odor Control	Pump
Aerosol	•	•	•	•	•	•			
Nonaerosol							•	•	•
Programmable	•	•	•	•	•				•
Refill Capacity	2	1	1	1	1	1	1	1	1
Refill Options	10	16	16	25	6	15	17	13	10
Refill Length (max. days)	180	168	180	168	180	30	90	30	168
Room Size (cu ft)	6,000	6,000	6,000	6,000	800 sq ft	300 sq ft	6,000	3,000	6,000
Battery Required	2 C Cell	2 C Cell	2 D Cell	2 D Cell	2 D Cell	2 D Cell		1 D Cell	1 D Cell

Microburst® Duet

Dual-fragrance aerosol dispensing odor-control system

Automatically alternates between two complementary scents for renewed freshness you will notice every day.

- Alternating scents eliminate fragrance fatigue
- Programmable freshness
- Cost-effective solution
- Superior design enhances décor
- Use with Microburst® Duet Refills
- All refills contain Microtrans® odor neutralizer



3485951

3485950

2 fragrances **are better than** **1**



FG4870002



FG4870056



FG4870001



FG4870055

Microburst® Duet Refills feature a unique combination of exclusively blended aromas from our industry-leading selection of premium fragrances.

Fragrances		Description	Intensity
Purifying Spa	Relaxing Spa	Crisp notes of lily and jasmine with a blend of chamomile and lavender	●
Linen Fresh™	Gentle Breeze	Delicate powdery notes and soft vanilla	●
Ocean Breeze	Sea Mist	A fresh accord with hints of cool, watery marine and clean fresh air	● ●
Mountain Peaks	Alpine Springs	A rich, seductive fragrance combining florals, precious woods, amber, and musk	● ● ●
Refreshing Citrus	Cotton Berry	Fresh mandarin combined with citrus and sweet berry	● ● ● ●



Two specially blended fragrances work in concert to provide a pleasant environment.

MICROBURST® DUET DISPENSERS

No.	Description	U.S. Dimensions	U.S. Ship Wt/Case	U.S. Case Cube	Metric Dimensions	Metric Ship Wt/Case	Metric Case Cube	Case Pack
FG4870001	Microburst® Duet Dispenser White/Grey Pearl	3.5" l x 5.2" w x 8.78" h	8.1 lb	0.63 ft³	8.9 cm x 13.2 cm x 23.3 cm	3.7 kg	0.018 m³	6
FG4870002	Microburst® Duet Dispenser Black/Black Pearl	3.5" l x 5.2" w x 8.78" h	8.1 lb	0.63 ft³	8.9 cm x 13.2 cm x 23.3 cm	3.7 kg	0.018 m³	6
FG4870055	Microburst® Duet Dispenser Black/Chrome	3.5" l x 5.2" w x 8.78" h	8.1 lb	0.63 ft³	8.9 cm x 13.2 cm x 23.3 cm	3.7 kg	0.018 m³	6
FG4870056	Microburst® Duet Dispenser White/White	3.5" l x 5.2" w x 8.78" h	8.1 lb	0.63 ft³	8.9 cm x 13.2 cm x 23.3 cm	3.7 kg	0.018 m³	6

MICROBURST® DUET REFILLS

New!

No.	Description	U.S. Dimensions	U.S. Ship Wt/Case	U.S. Case Cube	Metric Dimensions	Metric Ship Wt/Case	Metric Case Cube	Case Pack
1836255	Microburst® Duet Purifying/Relaxing Spa	2.375" l x 3.5" w x 5.25" h	3.0 lb	0.121 ft³	6.0 cm x 8.9 cm x 13.3 cm	1.4 kg	0.003 m³	4
3485949	Microburst® Duet Gentle Breeze/Linen Fresh™	2.375" l x 3.5" w x 5.25" h	3.0 lb	0.121 ft³	6.0 cm x 8.9 cm x 13.3 cm	1.4 kg	0.003 m³	4
3485950	Microburst® Duet Alpine Spring/Mountain Peaks	2.375" l x 3.5" w x 5.25" h	3.0 lb	0.121 ft³	6.0 cm x 8.9 cm x 13.3 cm	1.4 kg	0.003 m³	4
3485951	Microburst® Duet Ocean Breeze/Sea Mist	2.375" l x 3.5" w x 5.25" h	3.0 lb	0.121 ft³	6.0 cm x 8.9 cm x 13.3 cm	1.4 kg	0.003 m³	4
3485952	Microburst® Duet Cotton Berry/Refreshing Citrus	2.375" l x 3.5" w x 5.25" h	3.0 lb	0.121 ft³	6.0 cm x 8.9 cm x 13.3 cm	1.4 kg	0.003 m³	4
3486092	Microburst® Duet Variety Pack (1 of ea. refill)	2.375" l x 3.5" w x 5.25" h	3.0 lb	0.121 ft³	6.0 cm x 8.9 cm x 13.3 cm	1.4 kg	0.003 m³	1

Microburst® 3000 and 9000

Aerosol Odor Control Systems

Microburst® 3000 and 9000 aerosol dispensing systems deliver power, performance, and flexibility.



1793535

MICROBURST® 9000 SYSTEM
Reliable, lowest cost-in-use aerosol system.



BATTERY GAUGE
Shows battery life; battery lasts up to 36 months*
3000 – 2 C Cell
9000 – 2 D Cell

ALARM SYMBOL
Optional audio tone indicates need to change batteries and refill.

REFILL INDICATOR
Shows days remaining before refills need to be changed; refills last up to 168 days for 3000 dispensers, and up to 180 days for 9000 dispensers.

FLEXIBLE PROGRAMMING
Options include 12/24 hours per day and 5, 6, or 7 days per week.

1793533

MICROBURST® 3000 SYSTEM
Sleek, compact high-performance aerosol system.

DELIVERING COST-EFFECTIVE CUSTOMER DELIGHT

One 9000 refill will replace three standard refills – 90 to 180 days of maximum odor control from one refill. This also allows for less packaging per spray.

**9000
METERED
SPRAYS**



MICROBURST® 3000 DISPENSERS*

No.	Description	U.S. Dimensions	U.S. Ship Wt/Case	U.S. Case Cube	Metric Dimensions	Metric Ship Wt/Case	Metric Case Cube	Case Pack
1793531	Microburst® 3000 LCD Dispenser – Black	3.27" w x 7.24" h x 4.01" l	4.6 lb	0.012 ft³	9.60 cm x 18.39 cm x 10.19 cm	2.1 kg	0.09 m³	6
1793532	Microburst® 3000 LCD Dispenser – White	3.27" w x 7.24" h x 4.01" l	4.6 lb	0.012 ft³	9.60 cm x 18.39 cm x 10.19 cm	2.1 kg	0.09 m³	6
1793533	Microburst® 3000 LCD Dispenser – Chrome	3.27" w x 7.24" h x 4.01" l	5.0 lb	0.012 ft³	9.60 cm x 18.39 cm x 10.19 cm	2.3 kg	0.09 m³	6
FG401442	Microburst® 3000 Economizer Dispenser – White	2.06" w x 6.62" h x 3.31" l	6.0 lb	0.28 ft³	5.23 cm x 16.81 cm x 8.41 cm	2.7 kg		6

*Requires 2 C alkaline batteries (sold separately).

MICROBURST® 9000 DISPENSERS*

No.	Description	U.S. Dimensions	U.S. Ship Wt/Case	U.S. Case Cube	Metric Dimensions	Metric Ship Wt/Case	Metric Case Cube	Case Pack
1793534	Microburst® 9000 LCD Dispenser – Black	3.66" w x 9.52" h x 4.33" l	6.7 lb	0.019 ft³	9.65 cm x 23.67 cm x 10.99 cm	3.0 kg	0.14 m³	6
1793535	Microburst® 9000 LCD Dispenser – White	3.66" w x 9.52" h x 4.33" l	6.7 lb	0.019 ft³	9.65 cm x 23.67 cm x 10.99 cm	3.0 kg	0.14 m³	6
1793536	Microburst® 9000 LCD Dispenser – Chrome	3.66" w x 9.52" h x 4.33" l	6.7 lb	0.019 ft³	9.65 cm x 23.67 cm x 10.99 cm	3.0 kg	0.14 m³	6
FG401375	Microburst® 9000 Economizer Dispenser – White	3.56" w x 8.75" h x 2.87" l	5.6 lb	0.46 ft³	9.04 cm x 22.23 cm x 7.29 cm	2.5 kg		6

*Requires 2 D alkaline batteries (sold separately).

Microburst® 3000, 9000, and Standard Aerosol Refills

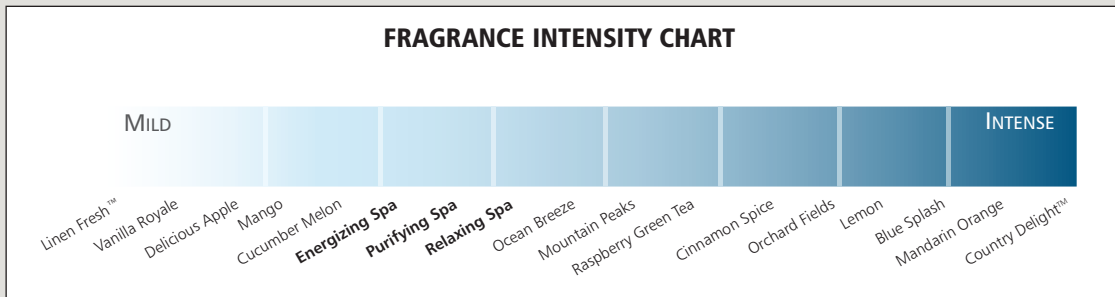

Microburst® Refills

Microtrans®, a true odor neutralizer, is paired with exclusive, high-quality fragrances to effectively eliminate unavoidable odor for longer lasting performance.

- Refill actuator distributes the finest mist for long-lasting fragrance patrons will notice
- Contains 63% less VOCs per spray than standard aerosol systems



MICROBURST® 3000 REFILLS

No.	Description	U.S. Ship Wt/Case	U.S. Case Cube	Metric Ship Wt/Case	Metric Case Cube	Case Pack
New! 1836139	Microburst® 3000 Refill – Purifying Spa	3 lb	0.14 ft³	1.4 kg	0.04 m³	12
New! 1836140	Microburst® 3000 Refill – Relaxing Spa	3 lb	0.14 ft³	1.4 kg	0.04 m³	12
New! 1836251	Microburst® 3000 Refill – Energizing Spa	3 lb	0.14 ft³	1.4 kg	0.04 m³	12
FG4012551	Microburst® 3000 Refill – Linen Fresh™	3 lb	0.14 ft³	1.4 kg	0.04 m³	12
FG4012561	Microburst® 3000 Refill – Orchard Fields	3 lb	0.14 ft³	1.4 kg	0.04 m³	12
FG4012571	Microburst® 3000 Refill – Mountain Peaks	3 lb	0.14 ft³	1.4 kg	0.04 m³	12
FG4012581	Microburst® 3000 Refill – Ocean Breeze	3 lb	0.14 ft³	1.4 kg	0.04 m³	12
FG4012591	Microburst® 3000 Refill – Country Delight™	3 lb	0.14 ft³	1.4 kg	0.04 m³	12
FG401689	Microburst® 3000 Refill – Cinnamon Spice	3 lb	0.14 ft³	1.4 kg	0.04 m³	12
FG401690	Microburst® 3000 Refill – Mango	3 lb	0.14 ft³	1.4 kg	0.04 m³	12
FG401691	Microburst® 3000 Refill – Vanilla Royale	3 lb	0.14 ft³	1.4 kg	0.04 m³	12
FG402355	Microburst® 3000 Refill – Blue Splash	3 lb	0.14 ft³	1.4 kg	0.04 m³	12
FG402408	Microburst® 3000 Refill – Mandarin Orange	3 lb	0.14 ft³	1.4 kg	0.04 m³	12
FG750362	Microburst® 3000 Refill – Raspberry Green Tea	3 lb	0.14 ft³	1.4 kg	0.04 m³	12
FG750363	Microburst® 3000 Refill – Cucumber Melon	3 lb	0.14 ft³	1.4 kg	0.04 m³	12
FG401260A*	Microburst® 3000 Refill – Preference Pack	3 lb	0.14 ft³	1.4 kg	0.04 m³	1 (10)

*FG401260A Preference Pack contains 2 refills each of Linen Fresh™, Orchard Fields, Mountain Peaks, Country Delight™, and Ocean Breeze.

MICROBURST® 9000 REFILLS

No.	Description	U.S. Ship Wt/Case	U.S. Case Cube	Metric Ship Wt/Case	Metric Case Cube	Case Pack
New! 1836252	Microburst® 9000 Refill – Purifying Spa	3 lb	0.16 ft³	1.4 kg	0.05 m³	4
New! 1836253	Microburst® 9000 Refill – Relaxing Spa	3 lb	0.16 ft³	1.4 kg	0.05 m³	4
New! 1836254	Microburst® 9000 Refill – Energizing Spa	3 lb	0.16 ft³	1.4 kg	0.05 m³	4
FG4012441	Microburst® 9000 Refill – Linen Fresh™	3 lb	0.16 ft³	1.4 kg	0.05 m³	4
FG4012451	Microburst® 9000 Refill – Orchard Fields	3 lb	0.16 ft³	1.4 kg	0.05 m³	4
FG4012461	Microburst® 9000 Refill – Mountain Peaks	3 lb	0.16 ft³	1.4 kg	0.05 m³	4
FG4012481	Microburst® 9000 Refill – Country Delight™	3 lb	0.16 ft³	1.4 kg	0.05 m³	4
FG4012471	Microburst® 9000 Refill – Ocean Breeze	3 lb	0.16 ft³	1.4 kg	0.05 m³	4
FG401692	Microburst® 9000 Refill – Cinnamon Spice	3 lb	0.16 ft³	1.4 kg	0.05 m³	4
FG401693	Microburst® 9000 Refill – Mango	3 lb	0.16 ft³	1.4 kg	0.05 m³	4
FG401694	Microburst® 9000 Refill – Vanilla Royale	3 lb	0.16 ft³	1.4 kg	0.05 m³	4
FG402354	Microburst® 9000 Refill – Blue Splash	3 lb	0.16 ft³	1.4 kg	0.05 m³	4
FG402093	Microburst® 9000 Refill – Mandarin Orange	3 lb	0.16 ft³	1.4 kg	0.05 m³	4
FG750365	Microburst® 9000 Refill – Raspberry Green Tea	3 lb	0.16 ft³	1.4 kg	0.05 m³	4
FG750366	Microburst® 9000 Refill – Cucumber Melon	3 lb	0.16 ft³	1.4 kg	0.05 m³	4
FG4012491*	Microburst® 9000 Refill – Preference Pack	4 lb	0.16 ft³	1.8 kg	0.05 m³	1 (5)

*FG4012491 Preference Pack contains 1 refill each of Linen Fresh™, Orchard Fields, Mountain Peaks, Country Delight™, and Ocean Breeze.

Standard Aerosol System

Standard Aerosol System offers automatic odor control for every budget.

- Smart chip technology maximizes odor control effectiveness for 30 to 168 days
- LCD model features adjustable spray intervals of 7, 14, or 28 minutes; 12/24 hours per day; or 5, 6, or 7 days per week
- LED model features adjustable spray intervals from 5 to 25 minutes and service intervals of 30, 45, or 60 days



No.	Description	U.S. Dimensions	U.S. Ship Wt/Case	U.S. Case Cube	Metric Dimensions	Metric Ship Wt/Case	Metric Case Cube	Case Pack
1793537	Standard Aerosol LED Dispenser – Black	4.13" w x 9.25" h x 4.13" l	3.15 lb	0.016 ft ³	10.49 cm x 23.50 cm x 10.49 cm	1.43 kg	0.14 m ³	6
1793538	Standard Aerosol LED Dispenser – White	4.13" w x 9.25" h x 4.13" l	3.15 lb	0.016 ft ³	10.49 cm x 23.50 cm x 10.49 cm	1.43 kg	0.14 m ³	6
1793539	Standard Aerosol LED Dispenser – Chrome	4.13" w x 9.25" h x 4.13" l	3.15 lb	0.016 ft ³	10.49 cm x 23.50 cm x 10.49 cm	1.43 kg	0.14 m ³	6
1793540	Standard Aerosol LCD Dispenser – Black	4.13" w x 9.25" h x 6.18" l	6.16 lb	0.019 ft ³	10.49 cm x 23.50 cm x 15.69 cm	2.79 kg	0.14 m ³	6
1793541	Standard Aerosol LCD Dispenser – White	4.13" w x 9.25" h x 6.18" l	5.79 lb	0.019 ft ³	10.49 cm x 23.50 cm x 15.69 cm	2.63 kg	0.14 m ³	6
1793542	Standard Aerosol LCD Dispenser – Chrome	4.13" w x 9.25" h x 6.18" l	6.12 lb	0.019 ft ³	10.49 cm x 23.50 cm x 15.69 cm	2.78 kg	0.14 m ³	6
FG400868	Standard Aerosol Service LED Dispenser – White	2.87" w x 8.75" h x 3.56" l	7.00 lb	0.46 ft ³	7.29 cm x 22.23 cm x 9.04 cm	3.18 kg	0.14 m ³	6
FG401375	Standard Aerosol Economizer – White	3.56" w x 8.75" h x 3.56" l	7.00 lb	0.46 ft ³				6

Standard Aerosol Refills

Odor control for 30 to 168 days.

- Wide variety of customer-friendly preferred fragrances
- All refills contain Microtrans® odor neutralizer
- Odor control for any budget



STANDARD AEROSOL REFILLS

No.	Description	U.S. Ship Wt/Case	U.S. Case Cube	Metric Ship Wt/Case	Metric Case Cube	Case Pack
1836136	Standard Aerosol – Purifying Spa	9.0 lb	0.31 ft ³	4.1 kg	0.09 m ³	12
1836137	Standard Aerosol – Relaxing Spa	9.0 lb	0.31 ft ³	4.1 kg	0.09 m ³	12
1836138	Standard Aerosol – Energizing Spa	9.0 lb	0.31 ft ³	4.1 kg	0.09 m ³	12
FG4009831	Standard Aerosol – Linen Fresh™	9.0 lb	0.31 ft ³	4.1 kg	0.09 m ³	12
FG4009841	Standard Aerosol – Orchard Fields	9.0 lb	0.31 ft ³	4.1 kg	0.09 m ³	12
FG4009851	Standard Aerosol – Mountain Peaks	9.0 lb	0.31 ft ³	4.1 kg	0.09 m ³	12
FG4015061	Standard Aerosol – Country Delight™	9.0 lb	0.31 ft ³	4.1 kg	0.09 m ³	12
FG4015471	Standard Aerosol – Ocean Breeze	9.0 lb	0.31 ft ³	4.1 kg	0.09 m ³	12
FG400573	Standard Aerosol – Vanilla Royale	9.0 lb	0.31 ft ³	4.1 kg	0.09 m ³	12
FG400696	Standard Aerosol – Cinnamon Spice	9.0 lb	0.31 ft ³	4.1 kg	0.09 m ³	12
FG401503	Standard Aerosol – Delicious Apple	9.0 lb	0.31 ft ³	4.1 kg	0.09 m ³	12
FG401504	Standard Aerosol – Mandarin Orange	9.0 lb	0.31 ft ³	4.1 kg	0.09 m ³	12
FG401695	Standard Aerosol – Mango	9.0 lb	0.31 ft ³	4.1 kg	0.09 m ³	12
FG402356	Standard Aerosol – Blue Splash	9.0 lb	0.31 ft ³	4.1 kg	0.09 m ³	12
FG401909	Standard Aerosol – Lemon	9.0 lb	0.31 ft ³	4.1 kg	0.09 m ³	12
FG401231*	Standard Aerosol – Preference Pack	8.5 lb	0.31 ft ³	3.9 kg	0.09 m ³	1 (10)

*FG401231 Preference Pack contains 2 refills each of Linen Fresh™, Orchard Fields, Mountain Peaks, Country Delight™, and Ocean Breeze.

STANDARD AEROSOL REFILLS – Global Collection

No.	Description	U.S. Ship Wt/Case	U.S. Case Cube	Metric Ship Wt/Case	Metric Case Cube	Case Pack
FG750295	Global Collection – Kilimanjaro	9.0 lb	0.31 ft ³	4.1 kg	0.09 m ³	12
FG750296	Global Collection – Island Cocktail	9.0 lb	0.31 ft ³	4.1 kg	0.09 m ³	12
FG750297	Global Collection – American Diner	9.0 lb	0.31 ft ³	4.1 kg	0.09 m ³	12
FG750298	Global Collection – Marrakesh	9.0 lb	0.31 ft ³	4.1 kg	0.09 m ³	12
FG750299	Global Collection – Mediterranean Charm	9.0 lb	0.31 ft ³	4.1 kg	0.09 m ³	12
FG750300	Global Collection – Oriental Nights	9.0 lb	0.31 ft ³	4.1 kg	0.09 m ³	12
FG750301	Global Collection – Ice Age	9.0 lb	0.31 ft ³	4.1 kg	0.09 m ³	12
FG750302	Global Collection – Rainforest	9.0 lb	0.31 ft ³	4.1 kg	0.09 m ³	12
FG750466*	Global Collection – Variety Pack	6.0 lb	0.31 ft ³	2.7 kg	0.09 m ³	1 (8)

*FG750466 Preference Pack contains 1 refill each of 8 fragrances in global collection.

New!
New!
New!

SeBreeze® Aerosol Programmable Plus™ Odor Neutralizing Unit

Fully programmable, premium dispenser with LCD display and audible alarm.

- Flexible programming options: 12 or 24 hr per day; 5, 6 or 7 days a week
- Trouble-free operation: 2 D cell Energizer (recommended) alkaline batteries last up to 3 years (not included)
- Ease of installation: Simple 1-minute installation for customer convenience and immediate results

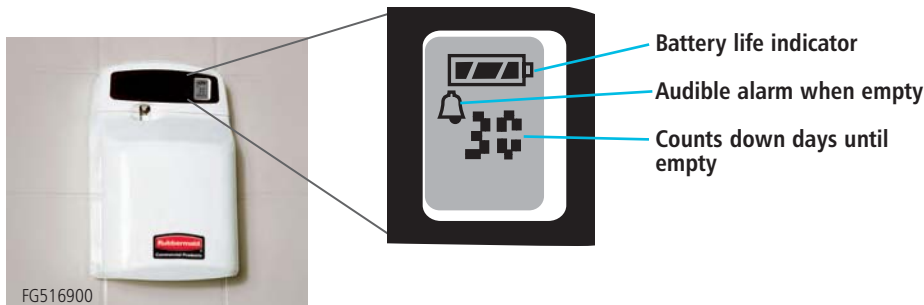

Economy SeBreeze® Aerosol Odor Neutralizing Unit

Easy to operate—no programming required.

- Automatic odor control: Unit activates every 15 minutes for 24/7
- Trouble-free operation: 2 D cell Energizer (recommended) alkaline batteries last up to 3 years (not included)
- Ease of installation: Simple 1-minute installation for customer convenience and immediate results



No.	Color	Description	U.S. Dimensions	U.S. Ship Wt/Ctn	Metric Dimensions	Metric Ship Wt/Ctn	Pack
FG513700*	OWHT	Economy SeBreeze® Aerosol Odor Neutralizing Unit	4.75" l x 3.13" w x 7.5" h	7.4 lb	12.1 cm x 8 cm x 19.1 cm	3.4 kg	6
FG516900*	OWHT	SeBreeze® Aerosol Programmable Plus™ Odor Neutralizing Unit	4.75" l x 3.13" w x 7.5" h	7.3 lb	12.1 cm x 8 cm x 19.1 cm	3.3 kg	6

*Compatible with SeBreeze® 9000 Series Refills and SeBreeze® 3000 Series Refills

SeBreeze® Series Refills

- Microtrans® odor neutralizer breaks down and eliminates malodors
- Powerful, consistent, fresh fragrances ensure patron satisfaction
- Delivers 3 times the odor control and fragrance as ordinary refills
- Contains 63% less volatile organic compounds



Fragrance	Description	Intensity
Orchard Harvest	Floral and Earthy	●
Spring Garden	Earthy and Woody	●
Citrus Breeze	Citrus and Floral	● ●
Country Linen	Fresh and Clean	●

SEBREEZE® 9000 SERIES REFILLS – Lasts up to 180 days in programmable unit

No.	Color	Description	U.S. Ship Wt/Ctn	Metric Ship Wt/Ctn	Pack
FG514500	0000	SeBreeze® 9000 Series Orchard Harvest Odor Neutralizer Aerosol Canister for FG513700 and FG516900 Units	3.0 lb	1.4 kg	4
FG515800	0000	SeBreeze® 9000 Series Spring Garden Odor Neutralizer Aerosol Canister for FG513700 and FG516900 Units	3.0 lb	1.4 kg	4
FG515900	0000	SeBreeze® 9000 Series Country Linen Odor Neutralizer Aerosol Canister for FG513700 and FG516900 Units	3.0 lb	1.4 kg	4
FG516000	0000	SeBreeze® 9000 Series Citrus Breeze Odor Neutralizer Aerosol Canister for FG513700 and FG516900 Units	3.0 lb	1.4 kg	4
FG516800	0000	SeBreeze® 9000 Series Aerosol Variety Pack, Contains 2 ea. of FG515800, FG514500, FG516000	4.0 lb	1.8 kg	1 case/6 pieces

SEBREEZE® 3000 SERIES REFILLS – Lasts up to 60 days in programmable unit

No.	Color	Description	U.S. Ship Wt/Ctn	Metric Ship Wt/Ctn	Pack
FG513800	0000	SeBreeze® 3000 Series Spring Garden Fragrance Aerosol Canister for FG513700 and FG516900 Units	9.0 lb	4.1 kg	12
FG513900	0000	SeBreeze® 3000 Series Citrus Breeze Fragrance Aerosol Canister for FG513700 and FG516900 Units	9.0 lb	4.1 kg	12

TCell™ Odor Control System

Rubbermaid Commercial Products' TCell™ System is the world's first continuous odor control system. Utilizing its patented delivery system, only TCell™ consistently delivers a precise dose of high-quality fragrance blended with Microtrans®, a true odor neutralizer, for 60 to 90 days without the use of batteries.

- **ONLY** passive system delivering consistent dosing over 60 or 90 days
- Compact, silent operation
- Sleek, attractive dispenser designs to match any décor
- Easy-to-use system requires no programming
- Features unique 90-degree spill protection
- Tamper-resistant



1793548



LIFETIME WARRANTY

Fully guaranteed against defects of parts and workmanship.

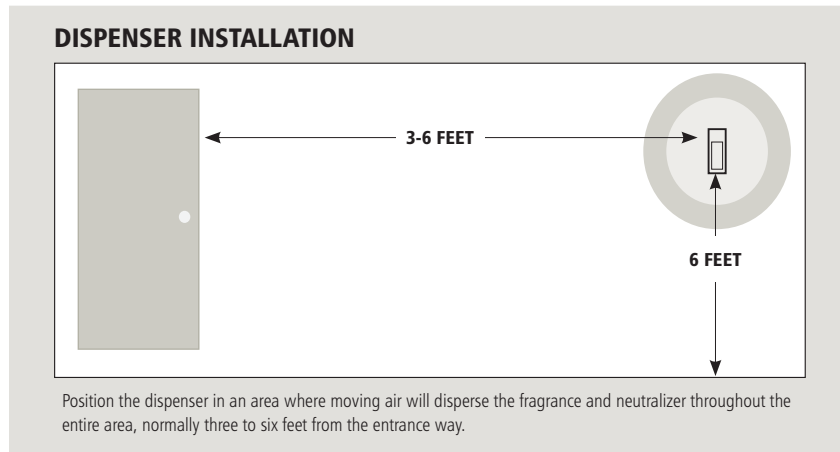

1793546



1793547



FG402430



1793544



1793545

TCELL™ DISPENSERS

No.	Description	U.S. Dimensions	U.S. Ship Wt/Case	U.S. Case Cube	Metric Dimensions	Metric Ship Wt/Case	Metric Case Cube	Case Pack
1793546	TCell™ Dispenser – Black	2.91" w x 5.91" h x 2.87" d	3.4 lb	0.013 ft³	7.39 cm x 15.01 cm x 7.29 cm	1.5 kg	0.0004 m³	12
1793547	TCell™ Dispenser – White	2.91" w x 5.91" h x 2.87" d	3.4 lb	0.013 ft³	7.39 cm x 15.01 cm x 7.29 cm	1.5 kg	0.0004 m³	12
1793548	TCell™ Dispenser – Chrome	2.91" w x 5.91" h x 2.87" d	3.4 lb	0.013 ft³	7.39 cm x 15.01 cm x 7.29 cm	1.5 kg	0.0004 m³	12
FG402430	TCell™ Heavy-Duty Dispenser	2.80" w x 5.37" h	7.5 lb	0.44 ft³	8.38 cm x 16 cm	3.4 kg	0.18 m³	12
1793543	TCell™ Fan Dispenser – Black	3.45" w x 6.81" h x 4.72" d	4.55 lb	0.026 ft³	8.76 cm x 17.30 cm x 11.99 cm	2.1 kg	0.0007 m³	12
1793544	TCell™ Fan Dispenser – White	3.45" w x 6.81" h x 4.72" d	4.55 lb	0.026 ft³	8.76 cm x 17.30 cm x 11.99 cm	2.1 kg	0.0007 m³	12
1793545	TCell™ Fan Dispenser – Chrome	3.45" w x 6.81" h x 4.72" d	4.55 lb	0.026 ft³	8.76 cm x 17.30 cm x 11.99 cm	2.1 kg	0.0007 m³	12
FG500551	TCell™ Dispenser – White and Cucumber Melon Refill	2.8" w x 5.37" h x 4.72" d	4.31 lb	0.51 ft³	7.11 cm x 13.63 cm x 11.99 cm	1.9 kg	0.14 m³	6
FG500552	TCell™ Dispenser – White and Mango Blossom Refill	2.8" w x 5.37" h x 4.72" d	4.31 lb	0.51 ft³	7.11 cm x 13.63 cm x 11.99 cm	1.9 kg	0.14 m³	6

TCell™ Refills

The TCell™ odor control system dispenses a consistent level of fragrance and Microtrans® odor neutralizer.

- On-trend, consumer-preferred fragrances
- Standard setting: 60 Days
- Light setting: 90 Days
- No propellants or added VOCs
- Recyclable refill components

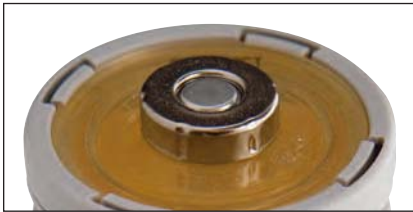

FUEL CELL TECHNOLOGY

The fuel cell creates hydrogen in the fragrance chamber. As each molecule of hydrogen is created, it forces an equal volume of fragrance and odor neutralizer out of the chamber. Natural airflow distributes the fragrance throughout the room.

TCell™ Odor Control Systems Refills

TCell™ provides the broadest fragrance and dispenser offering to represent consumer-preferred fragrance zones, increasing satisfaction for individual patrons. These exclusive, proprietary scents are offered individually or in a convenient "Preference Pack," which is a great solution for new customers to test and determine the right fragrance for their facility.

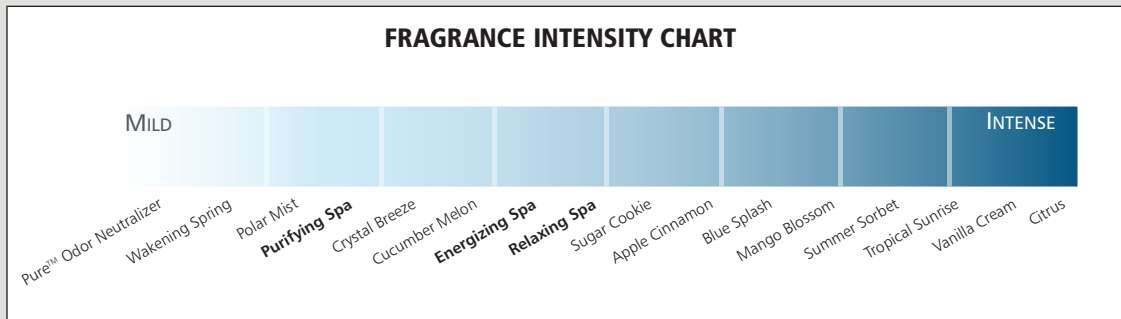

TCELL™ REFILLS

**New!
New!
New!**

No.	Description	U.S. Ship Wt/Case	U.S. Case Cube	Metric Ship Wt/Case	Metric Case Cube	Case Pack
1836256	TCell™ Refill – Purifying Spa	2.0 lb	0.11 ft³	0.9 kg	0.03 m³	6
1836257	TCell™ Refill – Relaxing Spa	2.0 lb	0.11 ft³	0.9 kg	0.03 m³	6
1836258	TCell™ Refill – Energizing Spa	2.0 lb	0.11 ft³	0.9 kg	0.03 m³	6
FG402110	TCell™ Refill – Wakening Spring	2.0 lb	0.11 ft³	0.9 kg	0.03 m³	6
FG402111	TCell™ Refill – Polar Mist	2.0 lb	0.11 ft³	0.9 kg	0.03 m³	6
FG402112	TCell™ Refill – Blue Splash	2.0 lb	0.11 ft³	0.9 kg	0.03 m³	6
FG402187	TCell™ Refill – Crystal Breeze	2.0 lb	0.11 ft³	0.9 kg	0.03 m³	6
FG402113	TCell™ Refill – Citrus	2.0 lb	0.11 ft³	0.9 kg	0.03 m³	6
FG402369	TCell™ Refill – Mango Blossom	2.0 lb	0.11 ft³	0.9 kg	0.03 m³	6
FG402470	TCell™ Refill – Cucumber Melon	2.0 lb	0.11 ft³	0.9 kg	0.03 m³	6
FG402472	TCell™ Refill – Tropical Sunrise	2.0 lb	0.11 ft³	0.9 kg	0.03 m³	6
FG402473	TCell™ Refill – Summer Sorbet	2.0 lb	0.11 ft³	0.9 kg	0.03 m³	6
FG402498	TCell™ Refill – Pure™ Odor Neutralizer	2.0 lb	0.11 ft³	0.9 kg	0.03 m³	6
FG750905	TCell™ Refill – Vanilla Cream	2.0 lb	0.11 ft³	0.9 kg	0.03 m³	6
FG750537	TCell™ Refill – Sugar Cookie	2.0 lb	0.11 ft³	0.9 kg	0.03 m³	6
FG750907	TCell™ Refill – Apple Cinnamon	2.0 lb	0.11 ft³	0.9 kg	0.03 m³	6
FG402236*	TCell™ Refill Preference Pack	2.0 lb	0.11 ft³	0.9 kg	0.03 m³	1 (5)

*FG402236 Preference Pack contains one refill each of Wakening Spring, Polar Mist, Blue Splash, Citrus, and Crystal Breeze.

SeBreeze® Adjustable Fan Dispenser

Long-lasting, effective odor control.

- Sturdy construction with adjustable vents to regulate airflow
- Refill with Fragrance Cassette® (battery included)
- Continuous odor control for 30 days
- Use in rooms up to 600 sq ft; includes mounting hardware



FG511400

SeBreeze® Portable Fan System

Ideal for small, confined areas.

- Stylish design suitable in any décor
- Refill with Fragrance Cassette® (battery included)
- Continuous odor control for 30 days
- Use in rooms up to 300 sq ft
- Can sit on flat surface or mount on wall
- Includes mounting hardware



FG9C9000

No.	Color	Description	U.S. Dimensions	U.S. Ship Wt/Ctn	Metric Dimensions	Metric Ship Wt/Ctn	Pack
FG511400	OWHT	SeBreeze® Adjustable Fan Dispenser	3.63" l x 3.5" w x 7.75" h	5.6 lb	9.2 cm x 8.9 cm x 19.7 cm	2.5 kg	6
FG9C9000	0000	SeBreeze® Portable Fan System	3.5" l x 2.63" w x 5.5" h	2.8 lb	8.9 cm x 6.7 cm x 14 cm	1.3 kg	6

Rubbermaid® Fragrance Cassette® with Odor-Absorbing Gel

Don't mask odors with heavy perfumes; eliminate them using Rubbermaid's Odor-Absorbing Gel Technology.

- Gels absorb odors in the air and convert them to nontoxic, odorless compounds
- Gel dissolves as it's used, providing a visual replacement cue
- See-through Fragrance Cassette® canister contains battery for easy one-step replacement
- 24-hour odor control for a full 30 days
- Neutral fragrance absorbs odors but leaves almost no scent for people sensitive to perfumes, such as those in hospitals and nursing homes



FG9C8501

Fragrance Chart

Name	Fragrance	Strength	Application
Citrus Breeze FG9C8401	Crisp, sparkling citrus	Full	Hospital wards, nursing homes, animal care, public sanitation facilities, restrooms
Lemon-Lime FG9C9401	Powerful natural lemon	Full	Hospital wards, nursing homes, animal care, public sanitation facilities, restrooms
Ocean Breeze FG9C8501	Clean, ozonic fragrance	Medium	Waiting areas, doctors' and dentists' offices, conference rooms, health clubs, restrooms, lounges, lobbies
Wintermint FG9C9501	Refreshing and cool	Medium	Public sanitation areas, food waste areas, waiting areas, health clubs, restrooms, lounges, lobbies, hospital wards
Lavender Bouquet FG9C8701	Light Floral, lavender	Light	Doctors' and dentists' offices, conference rooms, health clubs, restrooms, lounges, lobbies
Fresh Apple FG9C8301	Fresh apple pie	Light	Restaurants, offices, conference rooms, waiting areas, lounges, dressing rooms, nursing homes
Neutral FG9C8801/ FG9C9801	Absorbs odors with almost no scent	Light	Areas where there may be people sensitive to fragrances, such as hospitals and nursing homes
Cinnamon Spice FG9C9701	Warm apples and cinnamon	Light	Offices, conference rooms, waiting areas, lounges, dressing rooms, nursing homes

SEBREEZE® ODOR ABSORBING GEL

Fragrance Cassettes® for Adjustable Fan Dispenser (FG511400)

No.	Color	Description	U.S. Ship Wt/Ctn	Metric Ship Wt/Ctn	Pack
FG9C8301	0000	Fresh Apple	2.2 lb	1 kg	1 case/ 6 pieces
FG9C8401	0000	Citrus Breeze	2.2 lb	1 kg	1 case/ 6 pieces
FG9C8501	0000	Ocean Breeze	2.2 lb	1 kg	1 case/ 6 pieces
FG9C8701	0000	Lavender Bouquet	2.2 lb	1 kg	1 case/ 6 pieces
FG9C8801	0000	Neutral	2.2 lb	1 kg	1 case/ 6 pieces
FG9C8901	0000	Variety PK: 2 ea Citrus, Ocean, Lavender	2.2 lb	1 kg	1 case/ 6 pieces

SEBREEZE® ODOR ABSORBING GEL

Fragrance Cassettes® for Portable Fan Dispenser (FG9C9000)

No.	Color	Description	U.S. Ship Wt/Ctn	Metric Ship Wt/Ctn	Pack
FG9C9401	0000	Lemon-Lime	2.2 lb	1 kg	1 case/ 6 pieces
FG9C9501	0000	Wintermint	2.2 lb	1 kg	1 case/ 6 pieces
FG9C9701	0000	Cinnamon Spice	2.2 lb	1 kg	1 case/ 6 pieces
FG9C9801	0000	Neutral	2.2 lb	1 kg	1 case/ 6 pieces

Gel Odor Control System

Fully automatic system with high-performance gel refills to provide effective odor control for a full 30 days.

- Countertop or wall mounting capabilities
- Dispenser's Load n' Go operation makes the system a maintenance-free solution
- Effective in areas up to 3,000 cu ft



FG401220

GEL DISPENSER*

No.	Description	U.S. Dimensions	U.S. Ship Wt/Case	U.S. Case Cube	Metric Dimensions	Metric Ship Wt/Case	Metric Case Cube	Case Pack
FG401220*	Gel Economy Dispenser	3.6" w x 6" h	6.0 lb	0.31 ft ³	7.62 cm x 15.24 cm	2.7 kg	0.09 m ³	6

*Requires 1 D alkaline battery (sold separately).

GEL REFILLS

No.	Description	U.S. Ship Wt/Case	U.S. Case Cube	Metric Ship Wt/Case	Metric Case Cube	Case Pack
FG4012211	Gel—Linen Fresh™	3.0 lb	0.21 ft ³	1.4 kg	0.06 m ³	12
FG400262A1	Gel—Country Delight™	3.0 lb	0.21 ft ³	1.4 kg	0.06 m ³	12
FG4012241	Gel—Ocean Breeze	3.0 lb	0.21 ft ³	1.4 kg	0.06 m ³	12
FG400230A1	Gel—Mandarin Orange	3.0 lb	0.21 ft ³	1.4 kg	0.06 m ³	12
FG400250A1	Gel—Delicious Apple	3.0 lb	0.21 ft ³	1.4 kg	0.06 m ³	12
FG400260A1	Gel—Cinnamon Spice	3.0 lb	0.21 ft ³	1.4 kg	0.06 m ³	12
FG4012791	Gel—Cherry Berry	3.0 lb	0.21 ft ³	1.4 kg	0.06 m ³	12
FG750328	Gel—Vanilla Coconut	3.0 lb	0.21 ft ³	1.4 kg	0.06 m ³	12
FG750324	Gel—Green Citrus	3.0 lb	0.21 ft ³	1.4 kg	0.06 m ³	12
FG750327	Gel—Island Melon	3.0 lb	0.21 ft ³	1.4 kg	0.06 m ³	12

Pump Odor Control System

Pump system provides highly effective odor neutralizing through a dry spray pump in a nonaerosol system.

- Countertop or wall mounting capabilities
- Air neutralizers all contain Microtrans® Odor Neutralizer to lock onto malodor molecules transforming them into a neutral base that eliminates unavoidable odors in the washroom
- Replacing refills is simple and visual and audio cues provide notice when a refill or batteries will need to be replaced



1793509

PUMP DISPENSER*

No.	Description	U.S. Dimensions	U.S. Ship Wt/Case	U.S. Case Cube	Metric Dimensions	Metric Ship Wt/Case	Metric Case Cube	Case Pack
1793508*	Pump LCD Dispenser—Black	8.46" w x 10.23" h	9.22 lb	0.022 ft ³	21.49 cm x 26.04 cm	4.2 kg	0.006 m ³	6
1793509*	Pump LCD Dispenser—White	8.46" w x 10.23" h	9.22 lb	0.022 ft ³	21.49 cm x 26.04 cm	4.2 kg	0.006 m ³	6
1793510*	Pump LCD Dispenser—Chrome	8.46" w x 10.23" h	9.75 lb	0.022 ft ³	21.49 cm x 26.04 cm	4.4 kg	0.006 m ³	6
FG400695*	Pump LED Dispenser—White	4.88" w x 8.25" h	9.0 lb	0.65 ft ³	12.38 cm x 20.96 cm	4.1 kg	0.018 m ³	6

*Requires 1 D alkaline battery (sold separately).

PUMP REFILLS

No.	Description	U.S. Ship Wt/Case	U.S. Case Cube	Metric Ship Wt/Case	Metric Case Cube	Case Pack
FG400992A	Pump—Linen Fresh™	8.5 lb	0.36 ft ³	3.9 kg	0.11 m ³	12
FG401265	Pump—Vita Splash™	8.5 lb	0.36 ft ³	3.9 kg	0.11 m ³	12
FG401266	Pump—Mountain Spa™	8.5 lb	0.36 ft ³	3.9 kg	0.11 m ³	12
FG401906A	Pump—Country Delight™	8.5 lb	0.36 ft ³	3.9 kg	0.11 m ³	12
FG401904A	Pump—Ocean Breeze	8.5 lb	0.36 ft ³	3.9 kg	0.11 m ³	12
FG401902A	Pump—Santa Fe	8.5 lb	0.36 ft ³	3.9 kg	0.11 m ³	12
FG401268	Pump—Tropix	8.5 lb	0.36 ft ³	3.9 kg	0.11 m ³	12
FG401269	Pump—Vanilla	8.5 lb	0.36 ft ³	3.9 kg	0.11 m ³	12
FG401192	Pump—Pure™	8.5 lb	0.36 ft ³	3.9 kg	0.11 m ³	12
FG401273*	Pump—Preference Pack	8.5 lb	0.36 ft ³	3.9 kg	0.11 m ³	1 (10)

*FG401273 Preference Pack contains 2 refills each of Linen Fresh™, Vita Splash™, Mountain Spa™, Country Delight™, and Ocean Breeze.



One Shot® Touch-Free Soap System

The One Shot® System sets the standard for quality and reliability in counter-mounted soap dispensing. Luxurious formulas encourage healthy hand washing, and Smart Sensor™ technology detects hands, automatically delivering the perfect amount of soap—every time!

- Touch-free delivery eliminates cross-contamination to help reduce the spread of germs
- Reliable, controlled dispensing of concentrated soaps eliminates overuse and costly waste
- Refill and battery-life indicator lights
- Industry-leading battery life (up to 3 years or 120,000 cycles for One Shot® liquid dispensers, up to 2 years or 90,000 cycles for One Shot® foam dispensers)
- No clogs, drips, or messy cleanup
- Closed dispensing system provides world-class reliability
- Programmable options for 800mL and 1600mL refills
- Helps earn LEED credits



ADA COMPLIANT

ONE SHOT® FOAM DISPENSER

No.	Description ¹	U.S. Ship Wt/Case	U.S. Case Cube	Metric Ship Wt/Case	Metric Case Cube	Case Pack
FG750339	One Shot® Foam Dispenser Low-Profile – Polished Chrome	10.0 lb	1.52 ft ³	4.5 kg	0.04 m ³	4
FG4870465	One Shot® Foam Dispenser Low-Profile Metal – Polished Chrome	12.0 lb	1.52 ft ³	5.4 kg	0.04 m ³	4
490071	One Shot® A/C Adapter	1.2 lb	0.167 ft ³	0.5 kg	0.005 m ³	1

¹Requires 4 D alkaline batteries (sold separately) unless otherwise stated. Use Enriched Foam refills only. Not compatible with Enriched Lotion refills.

Enriched Foam Refills (for use with One Shot® Foam Dispensers)

- More hand washes per refill reduce labor and soap costs (up to 2,000 hand washes per refill)
- High-quality formulations enriched with moisturizers
- Boxless refill means 80% less packaging waste over bulk gallon
- Free 'N' Clean soap is specially formulated for frequent hand washing and NSF E1 approved²
- Sealed refill eliminates potential for contamination
- Green Seal™ * certified, biodegradable, and pH-balanced formulas



FG750389 / FG750390

FG750517 / FG750386



Green Seal™ applies to specific refills only; see below.

ENRICHED FOAM HAND WASH REFILLS

No.	Description ¹	Size	U.S. Ship Wt/Case	U.S. Case Cube	Metric Ship Wt/Case	Metric Case Cube	Case Pack
FG750517	Enriched Foam Hand Soap with Moisturizers	800 mL	9.5 lb	0.35 ft ³	4.3 kg	0.01 m ³	4
FG750386	Enriched Foam Hand Soap with Moisturizers	1600 mL	18.5 lb	0.62 ft ³	8.4 kg	0.02 m ³	4
FG750389	Enriched Foam Free 'N' Clean Soap – E1 ²	800 mL	9.5 lb	0.35 ft ³	4.3 kg	0.01 m ³	4
FG750390	Enriched Foam Free 'N' Clean Soap – E1 ²	1600 mL	18.5 lb	0.62 ft ³	8.4 kg	0.02 m ³	4

¹Use One Shot® Foam Dispensers only. ²NSF-approved E1 acceptable as a washing compound for use in establishments operating under the federal meat, poultry, shell egg grading, and egg products inspection programs.

*This product meets the Green Seal™ standard for institutional hand cleaners based on its reduced human and aquatic toxicity and reduced smog production potential.



FG401310



FG402073



FG401528



FG401832



FG402241



FG402243



FG750196

ONE SHOT® LIQUID DISPENSERS

No.	Description ¹	U.S. Ship Wt/Case	U.S. Case Cube	Metric Ship Wt/Case	Metric Case Cube	Case Pack
FG401310	One Shot® Liquid Dispenser – Polished Chrome/Black	8 lb	1.15 ft ³	3.63 kg	0.03 m ³	4
FG402073	One Shot® Liquid Dispenser – Polished Chrome	8 lb	1.15 ft ³	3.63 kg	0.03 m ³	4
FG401528	One Shot® Liquid Dispenser – Brushed Chrome/Black	8 lb	1.15 ft ³	3.63 kg	0.03 m ³	4
FG401832	One Shot® Liquid Dispenser Metal Spout – Polished Chrome/Black	10 lb	1.15 ft ³	4.5 kg	0.03 m ³	4
FG402241	One Shot® Liquid Dispenser Low-Profile – Polished Chrome	12 lb	1.15 ft ³	5.4 kg	0.03 m ³	4
FG402243	One Shot® Liquid Dispenser Low-Profile Metal – Polished Chrome	12 lb	1.15 ft ³	5.4 kg	0.03 m ³	4
FG750196	One Shot® Liquid Dispenser Low-Profile Metal – Brilliant Brass	12 lb	1.15 ft ³	5.4 kg	0.03 m ³	4
490071	One Shot® A/C Adapter	1.2 lb	0.167 ft ³	0.5 kg	0.005 m ³	1
FG500394	One Shot® 800 mL Starter Kit (Chrome/Black Dispenser, Hand Wash Refill, 4 D Batteries)	6 lb	0.40 ft ³	2.72 kg	0.01 m ³	1
FG500449	One Shot® 1600 mL Starter Kit (Chrome/Black Dispenser, Hand Wash Refill, 4 D Batteries)	8 lb	0.40 ft ³	3.63 kg	0.01 m ³	1
FG500582	One Shot® Low-Profile 800 mL Starter Kit (Chrome Dispenser, Hand Wash Refill, 4 D Batteries)	6 lb	0.40 ft ³	2.72 kg	0.01 m ³	1
FG500585	One Shot® Low-Profile 1600 mL Starter Kit (Chrome Dispenser, Hand Wash Refill, 4 D Batteries)	8 lb	0.40 ft ³	3.63 kg	0.01 m ³	1

¹Requires 4 D alkaline batteries (sold separately) unless otherwise stated. Use Enriched Lotion refills only. Not compatible with Enriched Foam refills.

Manual Soap System

Attractive, manually operated counter-mounted dispensing system.



ADA COMPLIANT



FG401544

MANUAL LIQUID DISPENSERS

No.	Description	U.S. Ship Wt/Case	U.S. Case Cube	Metric Ship Wt/Case	Metric Case Cube	Case Pack
FG401544	Manual Liquid Dispenser – Polished Chrome	7.5 lb	0.79 ft ³	3.4 kg	0.02 m ³	12

**Enriched Lotion Refills
(for use with One Shot® and Manual Liquid Dispensers)**

- More hand washes per refill reduce labor and soap costs (up to 2000 hand washes per refill)
- High-quality formulations enriched with moisturizers
- Sealed refill eliminates potential for contamination
- Wide choice of formulations including dye and fragrance-free, hypoallergenic, and antimicrobial options
- Green Seal™ *certified lotion soap



FG4013131 / FG4015431

FG402363 / FG402364

FG4013111 / FG4015411



Green Seal™ applies to specific refills only; see below.

ENRICHED LOTION HAND WASH REFILLS

No.	Description ¹	Size	U.S. Ship Wt/Case	U.S. Case Cube	Metric Ship Wt/Case	Metric Case Cube	Case Pack
FG4013131	Green Certified Lotion Soap	800 mL	9.0 lb	0.33 ft ³	4.1 kg	0.01 m ³	4
FG4015431	Green Certified Lotion Soap	1600 mL	18.0 lb	0.50 ft ³	8.2 kg	0.01 m ³	4
FG402363	Enriched Lotion Free 'N' Clean Soap	800 mL	9.0 lb	0.33 ft ³	4.1 kg	0.01 m ³	4
FG402364	Enriched Lotion Free 'N' Clean Soap	1600 mL	18.0 lb	0.50 ft ³	8.2 kg	0.01 m ³	4
FG4013111	Enriched Lotion Hand Soap with Moisturizers	800 mL	9.0 lb	0.33 ft ³	4.1 kg	0.01 m ³	4
FG4015411	Enriched Lotion Hand Soap with Moisturizers	1600 mL	18.0 lb	0.50 ft ³	8.2 kg	0.01 m ³	4
FG4013121	Enriched Lotion Antibacterial Hand Wash	800 mL	9.0 lb	0.33 ft ³	4.1 kg	0.01 m ³	4
FG4015421	Enriched Lotion Antibacterial Hand Wash	1600 mL	18.0 lb	0.50 ft ³	8.2 kg	0.01 m ³	4

¹Use One Shot® and Manual Liquid Dispensers only.

*This product meets the Green Seal™ standard for institutional hand cleaners based on its reduced human and aquatic toxicity and reduced smog production potential.

Auto Foam Touch-Free Skin Care System

Highest-quality foam soap in an attractive touch-free dispenser delivers superior cost savings.

- Touch-free delivery eliminates cross-contamination to help reduce the spread of germs
- Industry-leading battery life of 3 years or 120,000 hand washes¹
- Contemporary "clean look" dispenser available in a variety of color combinations to enhance the image of any washroom décor
- Refill level and battery-life indicators
- Boxless refill means 80% less packaging waste over bulk gallon
- ADA compliant force and one-handed operation
- Helps earn LEED credits



ADA COMPLIANT



5x
more
hand washes
than traditional
bag-in-box soaps

38%
more hand washes
than other foam systems



Hand Washes Per Refill

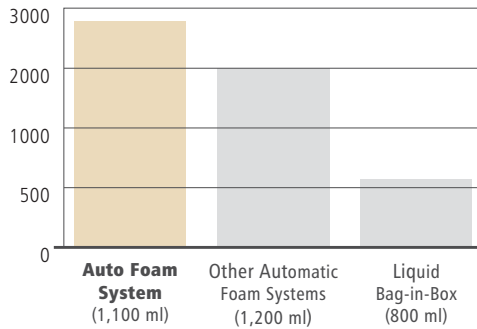

FG750127



FG750139



FG750138



FG750140



FG750411

AUTO FOAM DISPENSERS

No.	Description ¹	U.S. Dimensions	U.S. Ship Wt/Case	U.S. Case Cube	Metric Dimensions	Metric Ship Wt/Case	Metric Case Cube	Case Pack
FG750127	Auto Foam Dispenser – Black/Black Pearl	5.25" l x 5.18" w x 10.86" h	24.75 lb	25.25 ft ³	13.3 cm x 13.2 cm x 27.6 cm	11.2 kg	0.72 m ³	10
FG750138	Auto Foam Dispenser – White/Black Pearl	5.25" l x 5.18" w x 10.86" h	24.75 lb	25.25 ft ³	13.3 cm x 13.2 cm x 27.6 cm	11.2 kg	0.72 m ³	10
FG750139	Auto Foam Dispenser – Black/Grey Pearl	5.25" l x 5.18" w x 10.86" h	24.75 lb	25.25 ft ³	13.3 cm x 13.2 cm x 27.6 cm	11.2 kg	0.72 m ³	10
FG750140	Auto Foam Dispenser – White/Grey Pearl	5.25" l x 5.18" w x 10.86" h	24.75 lb	25.25 ft ³	13.3 cm x 13.2 cm x 27.6 cm	11.2 kg	0.72 m ³	10
FG750411	Auto Foam Dispenser – Black/Chrome	5.25" l x 5.18" w x 10.86" h	24.75 lb	25.25 ft ³	13.3 cm x 13.2 cm x 27.6 cm	11.2 kg	0.72 m ³	10

¹Requires 4 C alkaline batteries (not included) unless otherwise stated.

¹Based on internal testing.

Enriched Foam Refills (for use with Auto Foam Dispensers)

- More hand washes per refill reduce labor and soap costs
- High-capacity refill delivers up to 2,750 hand washes
- Moisture-enriched foam hand sanitizers in alcohol and alcohol-free formulas leave no sticky residue
- Hygienically sealed refills eliminate potential contamination
- Boxless refills evacuate fully to reduce waste
- Green Seal™* certified, biodegradable, and pH-balanced hand soap
- Antibacterial foam soap kills 99.99% of germs; NSF E2-rated
- NSF E3-rated foam alcohol hand sanitizer formula



FG750111



FG750112



Green Seal™ applies to specific refills only; see below.

FOAM HAND WASH

No.	Description	Size	U.S. Ship Wt/Case	U.S. Case Cube	Metric Ship Wt/Case	Metric Case Cube	Case Pack
FG750112	Enriched Foam Hand Soap with Moisturizers	1100 mL	10.9 lb	0.031 ft³	4.9 kg	0.01 m³	4
FG750111	Enriched Foam Antibacterial E2 Hand Soap – E2	1100 mL	10.9 lb	0.031 ft³	4.9 kg	0.01 m³	4



FG750591



FG750593

FOAM HAND SANITIZER

No.	Description	Size	U.S. Ship Wt/Case	U.S. Case Cube	Metric Ship Wt/Case	Metric Case Cube	Case Pack
FG750591	Enriched Foam Alcohol Hand Sanitizer – E3	1100 mL	10.9 lb	0.031 ft³	4.9 kg	0.01 m³	4
FG750593	Enriched Foam Alcohol-Free Hand Sanitizer	1100 mL	10.9 lb	0.031 ft³	4.9 kg	0.01 m³	4

Auto Foam Starter Kits and Sanitizing Station

- Economical Starter Kit includes 1 Dispenser, 1 Enriched Foam Hand Soap with Moisturizers refill
- Included are 4 C alkaline batteries
- Pair with the Auto Foam Station for a complete system



Green Seal™ applies to specific refills only; see below.



No.	Description	U.S. Dimensions	U.S. Ship Wt/Case	U.S. Case Cube	Metric Dimensions	Metric Ship Wt/Case	Metric Case Cube	Case Pack
FG750333	Auto Foam Starter Kit – White/Grey Pearl (dispenser, hand wash refill, 4 C batteries)	5.25" l x 5.18" w x 10.86" h	7.0 lb	0.49 ft³	13.3 cm x 13.2 cm x 27.6 cm	3.2 kg	0.01 m³	1
FG750334	Auto Foam Starter Kit – Black/Black Pearl (dispenser, hand wash refill, 4 C batteries)	5.25" l x 5.18" w x 10.86" h	7.0 lb	0.49 ft³	13.3 cm x 13.2 cm x 27.6 cm	3.2 kg	0.01 m³	1
FG751058	Auto Foam Starter Kit – Black/Chrome (dispenser, hand wash refill, 4 C batteries)	5.25" l x 5.18" w x 10.86" h	7.0 lb	0.49 ft³	13.3 cm x 13.2 cm x 27.6 cm	3.2 kg	0.01 m³	1
FG750824	Hand Sanitizer Station (Metal Stand) – Black	4" dia x 59.25" h	32.0 lb	2.73 ft³	35.6 cm dia x 150.5 cm	14.5 kg	0.08 m³	1

*This product meets the Green Seal™ standard for institutional hand cleaners based on its reduced human and aquatic toxicity and reduced smog production potential.

Rubbermaid Flex™ Manual Skin Care System



Rubbermaid Flex™ Skin Care System's revolutionary design allows you to use either foam or liquid refills in the same dispenser.

- Highest yield of hand washes—up to 3,250 per refill
- Signature Moisturizing Complex with shea butter, vitamin E, and panthenol
- Rich, dense lather and distinctive fragrances
- Rubbermaid's broadest selection of formulations including hand washes, shampoos, and sanitizers
- Accurate, adjustable, on-unit dose meter for effective portion control
- Superior "clean look" styling improves washroom aesthetics
- NSF-registered E2 and E3 formulas
- New 75% alcohol hand sanitizer kills over 99.99% of germs—E3-rated
- Unique alcohol-free hand sanitizer kills 99.99% of germs without alcohol—ideal for children (E3-rated)
- Fully ADA-compliant
- 2 sizes to meet any capacity, space, or installation requirement
- Hygienically sealed refills eliminate potential contamination
- Boxless refills evacuate fully to reduce waste



The only system with adjustable portion control ON the dispenser—choose from 3 dose sizes: 0.4 mL, 0.65 mL, or 1.0 mL.



RUBBERMAID FLEX™ SKIN CARE DISPENSERS

No.	Description	U.S. Dimensions	U.S. Ship Wt/Case	U.S. Case Cube	Metric Dimensions	Metric Ship Wt/Case	Metric Case Cube	Case Pack
3486589	Rubbermaid Flex™ Dispenser White – 500 mL	3.94" d x 5" w x 8.67" h	9.5 lb	1.36 ft³	10 cm x 12.7 cm x 22 cm	4.31 kg	0.04 m³	10
3486590	Rubbermaid Flex™ Dispenser Black – 500 mL	3.94" d x 5" w x 8.67" h	9.5 lb	1.36 ft³	10 cm x 12.7 cm x 22 cm	4.31 kg	0.04 m³	10
3486591	Rubbermaid Flex™ Dispenser White 1000 mL, 1300 mL	3.94" d x 5.75" w x 11.73" h	13.7 lb	1.91 ft³	10 cm x 14.6 cm x 29.8 cm	6.23 kg	0.04 m³	10
3486592	Rubbermaid Flex™ Dispenser Black 1000 mL, 1300 mL	3.94" d x 5.75" w x 11.73" h	13.7 lb	1.91 ft³	10 cm x 14.6 cm x 29.8 cm	6.23 kg	0.04 m³	10



ACCESSORIES & PARTS

No.	Description	U.S. Ship Wt/Case	U.S. Case Cube	Metric Ship Wt/Case	Metric Case Cube	Case Pack
3486593	Rubbermaid Flex™ Manual Dispenser Drip Tray – Grey	0.8 lb	0.29 ft³	0.36 kg	0.01 m³	6
3486594	Rubbermaid Flex™ Manual Dispenser Lock Plate – Grey	0.5 lb	0.25 ft³	0.64 kg	0.01 m³	10
3486595	Rubbermaid Flex™ Manual Dispenser Lock Plate Key	0.5 lb	0.05 ft³	0.64 kg	0.01 m³	10
3486596	Rubbermaid Flex™ Wall Bracket for 18-oz Bottle	2.6 lb	0.13 ft³	1.18 kg	0.01 m³	4
3486597	Rubbermaid Flex™ Manual Dispenser Screw Packet	0.5 lb	0.05 ft³	0.64 kg	0.01 m³	10

Enriched Foam Refills (for use with Rubbermaid FLeX™ Dispensers)



NSF and Green Seal™ apply to specific refills only; see below.



FOAM HAND WASH AND BODY SHAMPOO

No.	Description	Size	U.S. Ship Wt/Case	U.S. Case Cube	Metric Ship Wt/Case	Metric Case Cube	Case Pack
3486561	Enriched Foam Hand Wash	500 mL	6.64 lb	.41 ft³	3.01 kg	0.01 m³	5
3486571	Enriched Foam Hand Wash	1300 mL	9.75 lb	.48 ft³	4.42 kg	0.01 m³	3
3486573	Enriched Foam Antibacterial Hand Wash – E2	1300 mL	10.30 lb	.48 ft³	4.67 kg	0.01 m³	3
3486575	Enriched Foam Hand and Body Shampoo	1300 mL	9.74 lb	.48 ft³	4.42 kg	0.01 m³	3

FOAM HAND SANITIZERS

No.	Description	Size	U.S. Ship Wt/Case	U.S. Case Cube	Metric Ship Wt/Case	Metric Case Cube	Case Pack
3486577	Enriched Foam Alcohol Plus Hand Sanitizer – E3	1000 mL	8.56 lb	.48 ft³	3.88 kg	0.01 m³	3
3486586	Enriched Foam Alcohol Plus Hand Sanitizer – E3	1.7-oz Bottle	3.96 lb	.18 ft³	1.80 kg	0.01 m³	24
3486582	Enriched Foam Alcohol Plus Hand Sanitizer – E3	18-oz Bottle	8.10 lb	.36 ft³	3.67 kg	0.01 m³	6
3486579	Enriched Foam Alcohol-Free Plus Hand Sanitizer – E3	1300 mL	9.67 lb	.48 ft³	4.39 kg	0.01 m³	3

Enriched Lotion Refills (for use with Rubbermaid FLeX™ Dispensers)



NSF and Green Seal™ apply to specific refills only; see below.



LIQUID HAND WASH AND BODY SHAMPOO

No.	Description	Size	U.S. Ship Wt/Case	U.S. Case Cube	Metric Ship Wt/Case	Metric Case Cube	Case Pack
3486562	Enriched Lotion Hand Wash	500 mL	6.77 lb	.41 ft³	3.07 kg	0.01 m³	5
3486572	Enriched Lotion Hand Wash	1300 mL	9.82 lb	.48 ft³	4.45 kg	0.01 m³	3
3486574	Enriched Lotion Antibacterial Hand Wash – E2	1300 mL	10.24 lb	.48 ft³	4.64 kg	0.01 m³	3
3486576	Enriched Lotion Hand and Body Shampoo	1300 mL	10.15 lb	.48 ft³	4.60 kg	0.01 m³	3

*This product meets the Green Seal™ standard for institutional hand cleaners based on its reduced human and aquatic toxicity and reduced smog production potential.

Foam Skin Care System

The perfect balance between quality and value.

- Metered pump provides controlled dose of high-density foam for up to 2,500 hand washes per refill
- Antimicrobial push bar
- Hygienic sealed refills keep soap fresh and clean
- Highly concentrated foam hand cleansers



FG750590



FG450017



FG450034

FOAM SKIN CARE DISPENSERS

No.	Description	U.S. Dimensions	U.S. Ship Wt/Case	U.S. Case Cube	Metric Dimensions	Metric Ship Wt/Case	Metric Case Cube	Case Pack
FG450017	Foam Skin Care Dispenser 800 mL, 1000 mL – White	2.55" l x 1.2" w x 1.15" h	1.3 lb	2.04 ft³	6.5 cm x 3 cm x 2.9 cm	0.6 kg	0.06 m³	10
FG450034	Foam Skin Care Dispenser 800 mL, 1000 mL – Black	2.55" l x 1.2" w x 1.15" h	1.0 lb	2.17 ft³	6.5 cm x 3 cm x 2.9 cm	0.5 kg	0.06 m³	10
FG750382	Foam Skin Care Dispenser 800 mL, 1000 mL – Stainless Steel	2.55" l x 1.2" w x 1.15" h	1.3 lb	2.04 ft³	6.5 cm x 3 cm x 2.9 cm	0.6 kg	0.06 m³	10

ENRICHED FOAM HAND WASH REFILLS (FOR USE WITH FOAM SKIN CARE DISPENSER)

No.	Description	Size	U.S. Ship Wt/Case	U.S. Case Cube	Metric Ship Wt/Case	Metric Case Cube	Case Pack
FG450019	Foam Hand Soap with Moisturizers	800 mL	12.8 lb	0.33 ft³	5.8 kg	0.01 m³	6
FG750383	Foam Hand Soap with Moisturizers	1000 mL	16.5 lb	0.39 ft³	7.5 kg	0.01 m³	6
FG450031	Foam Antibacterial Soap – E2	800 mL	12.8 lb	0.33 ft³	5.8 kg	0.01 m³	6
FG4870178	Foam Antibacterial Soap – E2	1000 mL	15.4 lb	0.44 ft³	7.0 kg	0.01 m³	6
FG450027	Foam Free 'N' Clean Soap	1000 mL	16.5 lb	0.39 ft³	7.5 kg	0.01 m³	6
FG500624	Starter Kit – Lotion Soap with Moisturizers	800 mL	3.4 lb	0.40 ft³	1.5 kg	0.01 m³	1

ENRICHED FOAM HAND AND BODY WASH REFILLS (FOR USE WITH FOAM SKIN CARE DISPENSER)

No.	Description	Size	U.S. Ship Wt/Case	U.S. Case Cube	Metric Ship Wt/Case	Metric Case Cube	Case Pack
FG751001	Foam Hair and Body Wash	800 mL	12.8 lb	0.33 ft³	5.8 kg	0.01 m³	6

ENRICHED FOAM HAND SANITIZERS (FOR USE WITH FOAM SKIN CARE DISPENSER)

No.	Description	Size	U.S. Ship Wt/Case	U.S. Case Cube	Metric Ship Wt/Case	Metric Case Cube	Case Pack
FG750592	Foam Alcohol-Free Hand Sanitizer	800 mL	12.8 lb	0.33 ft³	5.8 kg	0.01 m³	6
FG750590	Foam Alcohol Hand Sanitizer	800 mL	12.8 lb	0.33 ft³	5.8 kg	0.01 m³	6

ACCESSORIES AND PARTS

No.	Description	U.S. Ship Wt/Case	U.S. Case Cube	Metric Ship Wt/Case	Metric Case Cube	Case Pack
750615	Foam Skin Care Dispenser Back Plate – White	N/A	N/A	N/A	N/A	N/A
750616	Foam Skin Care Dispenser Back Plate – Black	N/A	N/A	N/A	N/A	N/A
751060	Foam Soap 1000 mL Pouch Holder	N/A	N/A	N/A	N/A	N/A
750242	Foam Soap Dispenser Key and Lock	N/A	N/A	N/A	N/A	N/A

Spray Skin Care System

Cost-effective and environmentally responsible spray soap system.

- Delivers up to 4,000 hand washes per 800 mL refill and up to 2,000 hand washes per 400 mL refill
- Revolutionary spray delivers thorough coverage of highly concentrated soap
- Soap lathers well and contains skin conditioning ingredients
- New pump with every refill eliminates mess, clogs, and leaks
- Disposable, sealed refills keep soap fresh and free from contamination



FG450011

FG450009

FG450008

FG450033



NSF and Green Seal™ apply to specific refills only; see below.

SPRAY SKIN CARE DISPENSERS

No.	Description	U.S. Dimensions	U.S. Ship Wt/Case	U.S. Case Cube	Metric Dimensions	Metric Ship Wt/Case	Metric Case Cube	Case Pack
FG450008	Spray Dispenser 400 mL – White	4.3" l x 3.7" w x 8.25" h	1.0 lb	1.9 ft³	10.9 cm x 9.4 cm x 21 cm	0.5 kg	0.05 m³	12
FG450033	Spray Dispenser 400 mL – Black	4.3" l x 3.7" w x 8.25" h	1.0 lb	1.9 ft³	10.9 cm x 9.4 cm x 21 cm	0.5 kg	0.05 m³	12

SPRAY REFILLS (FOR USE WITH SPRAY DISPENSERS)

No.	Description	Size	U.S. Ship Wt/Case	U.S. Case Cube	Metric Ship Wt/Case	Metric Case Cube	Case Pack
FG450011	Spray Hand Soap with Moisturizers	400 mL	12.1 lb	0.30 ft³	5.5 kg	0.01 m³	12
FG450012	Spray Antibacterial Soap	400 mL	12.1 lb	0.30 ft³	5.5 kg	0.01 m³	12
FG450009	Spray Hand Soap with Moisturizers	800 mL	11.8 lb	0.25 ft³	5.4 kg	0.01 m³	6
FG450010	Spray Antibacterial Soap	800 mL	11.8 lb	0.25 ft³	5.4 kg	0.01 m³	6
FG500625	Starter Kit – Lotion Soap with Moisturizers	400 mL	2.0 lb	0.18 ft³	0.9 kg	0.01 m³	1

Spray Hand Sanitizer System

Superior sanitizing system kills 99.99% of harmful germs.

- Proven in laboratory tests to increase the moisture content of skin from 12% to 16%
- Spray delivery provides thorough hand coverage and dries rapidly with no stickiness
- NSF registered E3 as appropriate for food service uses



FG450030

FG450032

FG450026

FG750176



SPRAY HAND SANITIZER DISPENSER

No.	Description	U.S. Dimensions	U.S. Ship Wt/Case	U.S. Case Cube	Metric Dimensions	Metric Ship Wt/Case	Metric Case Cube	Case Pack
FG450026	Manual Spray Dispenser 400 mL – White	5.12" l x 3.75" w x 8.75" h	11.4 lb	1.45 ft³	13 cm x 9.5 cm x 22.2 cm	5.2 kg	0.04 m³	12
FG750176	Manual Spray Dispenser 400 mL – Metallic	5.12" l x 3.75" w x 8.75" h	11.4 lb	1.45 ft³	13 cm x 9.5 cm x 22.2 cm	5.2 kg	0.04 m³	12

MOISTURIZING SPRAY HAND SANITIZER REFILL AND TRAVEL SIZE

No.	Description	Size	U.S. Ship Wt/Case	U.S. Case Cube	Metric Ship Wt/Case	Metric Case Cube	Case Pack
FG450030	Spray Moisturizing Hand Sanitizer – E3	400 mL	1.0 lb	0.27 ft³	0.5 kg	0.01 m³	12
FG450032	Spray Moisturizing Hand Sanitizer Bottle – E3	59 mL / 2 oz	0.2 lb	0.27 ft³	0.1 kg	0.01 m³	36

SPRAY HAND SANITIZER STARTER KIT

No.	Description	Size	U.S. Ship Wt/Case	U.S. Case Cube	Metric Ship Wt/Case	Metric Case Cube	Case Pack
FG500626	Spray Hand Sanitizer Starter Kit	400 mL	1.85 lb	0.18 ft³	0.8 kg	0.01 m³	1

*This product meets the Green Seal™ standard for institutional hand cleaners based on its reduced human and aquatic toxicity and reduced smog production potential.

**ProRx™
Skin Care System**

Rubbermaid's new ProRx™ Skin Care System is your skin health prescription for hard-working hands.

- Increase productivity by keeping hard-working hands clean, healthy, and on the job
- Clean broad range of soils quickly and effectively—from light to heavy soils
- Natural grit scrubbers boost cleaning power; safe for skin and the environment
- Signature Moisturizing Complex with bamboo extract and aloe vera
- Skin-friendly formulations contain no harsh solvents or irritants
- Highest yield of hand washes—up to 3,333 per refill
- Lowest waste—industry-leading refill evacuation and controlled dosing



- Superior Cleaning
- Superior Skin Feel
- Superior Environmental Choice



The only system with adjustable portion control ON the dispenser—choose from 3 dose sizes: 0.4 mL, 0.65 mL, or 1.0 mL.

Up to
4x
more hand washes
than other soap systems!

100%
of hand soap ingredients are biodegradable
safer for the environment and your hands

PRORX™ SKIN CARE DISPENSERS

No.	Description	U.S. Dimensions	U.S. Ship Wt/Case	U.S. Case Cube	Metric Dimensions	Metric Ship Wt/Case	Metric Case Cube	Case Pack
1780885	ProRx™ Dispenser White – 2 L	7.86" l x 7.2" w x 15.56" h	13.49 lb	2.08 ft³	19.9 cm x 18.3 cm x 39.5 cm	6.12 kg	0.06 m³	4
1780886	ProRx™ Dispenser Black – 2 L	7.86" l x 7.2" w x 15.56" h	13.49 lb	2.08 ft³	19.9 cm x 18.3 cm x 39.5 cm	6.12 kg	0.06 m³	4

ACCESSORIES AND PARTS

No.	Description	U.S. Dimensions	U.S. Ship Wt/Case	U.S. Case Cube	Metric Dimensions	Metric Ship Wt/Case	Metric Case Cube	Case Pack
1780889	ProRx™ Washfountain Mounting Adapter – 2" dia	10.5" l x 10.5" w x 12" h	4.8 lb	1.53 ft³	26.7 cm x 26.7 cm x 30.5 cm	2.18 kg	0.04 m³	1
1780890	ProRx™ Washfountain Mounting Adapter – 4" dia	10.5" l x 10.5" w x 12" h	4.8 lb	1.53 ft³	26.7 cm x 26.7 cm x 30.5 cm	2.18 kg	0.04 m³	1
1780891	ProRx™ Bracket for 64-oz Bottle		9.5 lb	5.38 ft³		4.31 kg	0.15 m³	4

¹Based on internal testing.

**Enriched Lotion Refills
(for use with ProRx™ Dispensers)**

- Durable, low-maintenance dispensing system with hygienic disposable refill—no drips, no breakdown
- Preferred environmental choice—recyclable refills, biodegradable, natural grit scrubbers



HAND CLEANERS AND BODY WASH

No.	Description	Size	U.S. Ship Wt/Case	U.S. Case Cube	Metric Ship Wt/Case	Metric Case Cube	Case Pack
1780875	Enriched Lotion Multi-Duty Hand Cleaner with Scrubbers	2 L	19.63 lb	0.73 ft³	8.90 kg	0.02 m³	4
1780877	Enriched Lotion Super-Duty Hand Cleaner with Scrubbers	2 L	19.63 lb	0.73 ft³	8.90 kg	0.02 m³	4

Auto Faucet®

Auto Faucet® sets the standard for reliability and user-friendly performance in automated faucet systems. Equipped with Surround Sensor™ Technology, Auto Faucet® delivers water only when needed, resulting in water savings of up to 70 percent.

- Touch-free activation eliminates cross-contamination to help reduce the spread of germs
- Surround Sensor™ Technology creates a 3" omni-directional sensing zone guaranteeing activation every time
- "Dry" cam-gear technology (solenoid valve-free) ensures trouble-free operation to reduce maintenance
- Long battery life—400,000 cycles or 3 years (4 D batteries included)
- Also available with optional AC power adapter



UP TO
70%
water savings



USER-FRIENDLY PERFORMANCE

Surround Sensor™ Technology creates a 3" omnidirectional sensing zone guaranteeing activation every time.

Aesthetically Superior Design Enhances Décor

Contemporary, stylish fixtures are available in a wide array of spout designs and finishes to enhance the image and coordinate with any washroom décor.



All Auto Faucet® models come standard with an auto open line purge feature that eliminates the stagnant water that can lead to bacterial growth.



SUSTAINABLE DESIGN

Auto Faucet® delivers water only when needed to achieve up to 70% water savings and earn LEED credits. Auto Faucet® systems' dry cam-gear technology requires less energy to operate, providing exceptional battery life of over 400,000 hand washes (AC power option available).



Milano



Verona



Capri

AUTO FAUCET®* SINGLE HOLE MOUNT

No.	Description	U.S. Dimension	U.S. Ship Wt/Case	U.S. Case Cube	Metric Dimension	Metric Ship Wt/Case	Metric Case Cube	Kit	Case Pack
FG401818	Milano in Polished Chrome	6.5" l x 2.13" w x 3.75" h	6 lb	0.26 ft ³	16.5 cm x 5.4 cm x 9.5 cm	2.72 kg	0.01 m ³	1	1
FG500480	Milano in Polished Chrome	6.5" l x 2.13" w x 3.75" h	6 lb	0.26 ft ³	16.5 cm x 5.4 cm x 9.5 cm	2.72 kg	0.01 m ³	2	1
1782742	Milano in Polished Chrome (Low Lead)	6.5" l x 2.13" w x 3.75" h	6 lb	0.26 ft ³	16.5 cm x 5.4 cm x 9.5 cm	2.72 kg	0.01 m ³	3	1
FG500615	Milano in Polished Chrome	6.5" l x 2.13" w x 3.75" h	6 lb	0.26 ft ³	16.5 cm x 5.4 cm x 9.5 cm	2.72 kg	0.01 m ³	4	1
1818966	Milano in Polished Chrome (Low Lead)	6.5" l x 2.13" w x 3.75" h	6 lb	0.26 ft ³	16.5 cm x 5.4 cm x 9.5 cm	2.72 kg	0.01 m ³	4	1
FG500483	Milano in Polished Chrome	6.5" l x 2.13" w x 3.75" h	7 lb	0.26 ft ³	16.5 cm x 5.4 cm x 9.5 cm	3.18 kg	0.01 m ³	6	1
FG401824	Milano in Polished Brass	6.5" l x 2.13" w x 3.75" h	6 lb	0.26 ft ³	16.5 cm x 5.4 cm x 9.5 cm	2.72 kg	0.01 m ³	3	1
FG750181	Milano in Polished Brass	6.5" l x 2.13" w x 3.75" h	6 lb	0.26 ft ³	16.5 cm x 5.4 cm x 9.5 cm	2.72 kg	0.01 m ³	4	1
FG500564	Milano in Satin Nickel	6.5" l x 2.13" w x 3.75" h	6 lb	0.26 ft ³	16.5 cm x 5.4 cm x 9.5 cm	2.72 kg	0.01 m ³	3	1
FG750596	Verona in Polished Chrome	6.75" l x 2.5" w x 5" h	6 lb	0.26 ft ³	17.15 cm x 6.35 cm x 12.7 cm	2.72 kg	0.01 m ³	1	1
FG500648	Verona in Polished Chrome	6.75" l x 2.5" w x 5" h	6 lb	0.26 ft ³	17.15 cm x 6.35 cm x 12.7 cm	2.72 kg	0.01 m ³	2	1
FG500554	Verona in Polished Chrome	6.75" l x 2.5" w x 5" h	6 lb	0.26 ft ³	17.15 cm x 6.35 cm x 12.7 cm	2.72 kg	0.01 m ³	3	1
FG500640	Verona in Polished Chrome	6.75" l x 2.5" w x 5" h	6 lb	0.26 ft ³	17.15 cm x 6.35 cm x 12.7 cm	2.72 kg	0.01 m ³	4	1
FG500555	Sienna in Polished Chrome	7" l x 2.25" w x 3.5" h	6 lb	0.26 ft ³	17.78 cm x 5.72 cm x 8.89 cm	2.72 kg	0.01 m ³	3	1
FG500645	Sienna in Polished Chrome	7" l x 2.25" w x 3.5" h	6 lb	0.26 ft ³	17.78 cm x 5.72 cm x 8.89 cm	2.72 kg	0.01 m ³	4	1
FG750084	Capri in Polished Chrome	7" l x 2.5" w x 3.5" h	6 lb	0.26 ft ³	17.78 cm x 6.35 cm x 8.89 cm	2.72 kg	0.01 m ³	2	1
FG500556	Capri in Polished Chrome	7" l x 2.5" w x 3.5" h	6 lb	0.26 ft ³	17.78 cm x 6.35 cm x 8.89 cm	2.72 kg	0.01 m ³	3	1
FG500651	Capri in Polished Chrome	7" l x 2.5" w x 3.5" h	6 lb	0.26 ft ³	17.78 cm x 6.35 cm x 8.89 cm	2.72 kg	0.01 m ³	4	1
FG750269	Venetian 3.5" in Polished Chrome	4.85" l x 2" w x 9.4" h	6 lb	0.26 ft ³	12.32 cm x 5.08 cm x 23.88 cm	2.72 kg	0.01 m ³	2	1
FG500609	Venetian 3.5" in Polished Chrome	4.85" l x 2" w x 9.4" h	6 lb	0.26 ft ³	12.32 cm x 5.08 cm x 23.88 cm	2.72 kg	0.01 m ³	3	1
FG750172	Venetian 3.5" in Polished Chrome	4.85" l x 2" w x 9.4" h	6 lb	0.26 ft ³	12.32 cm x 5.08 cm x 23.88 cm	2.72 kg	0.01 m ³	4	1
FG750099	Venetian 5.5" in Polished Chrome	7.63" l x 2" w x 10" h	6 lb	0.26 ft ³	19.38 cm x 5.08 cm x 25.4 cm	2.72 kg	0.01 m ³	3	1
FG750353	Venetian 5.5" in Polished Chrome	7.63" l x 2" w x 10" h	6 lb	0.26 ft ³	19.38 cm x 5.08 cm x 25.4 cm	2.72 kg	0.01 m ³	4	1

*Supplied with 1.5 GPM (5.7 L/min.) laminar flow; can be ordered with Flow Control Aerator that delivers 0.5 GPM, 1.0 GPM, 1.5 GPM, 2.0 GPM, or 2.2 GPM.

AUTO FAUCET®* 4" CENTER SET

No.	Description	U.S. Dimensions	U.S. Ship Wt/Case	U.S. Case Cube	Metric Dimensions	Metric Ship Wt/Case	Metric Case Cube	Kit	Case Pack
FG500478	Milano in Polished Chrome	6.5" l x 2.13" w x 3.75" h	7.0 lb	0.26 ft ³	16.5 cm x 5.4 cm x 9.5 cm	3.18 kg	0.01 m ³	1	1
FG500481	Milano in Polished Chrome	6.5" l x 2.13" w x 3.75" h	7.0 lb	0.26 ft ³	16.5 cm x 5.4 cm x 9.5 cm	3.18 kg	0.01 m ³	2	1
1782743	Milano in Polished Chrome (Low Lead)	6.5" l x 2.13" w x 3.75" h	7.0 lb	0.26 ft ³	16.5 cm x 5.4 cm x 9.5 cm	3.18 kg	0.01 m ³	3	1
FG500616	Milano in Polished Chrome	6.5" l x 2.13" w x 3.75" h	7.0 lb	0.26 ft ³	16.5 cm x 5.4 cm x 9.5 cm	3.18 kg	0.01 m ³	4	1
1818967	Milano in Polished Chrome (Low Lead)	6.5" l x 2.13" w x 3.75" h	6 lb	0.26 ft ³	16.5 cm x 5.4 cm x 9.5 cm	2.72 kg	0.01 m ³	4	1
FG750399	Milano in Polished Chrome	6.5" l x 2.13" w x 3.75" h	7.0 lb	0.26 ft ³	16.5 cm x 5.4 cm x 9.5 cm	3.18 kg	0.01 m ³	5	1
FG500484	Milano in Polished Chrome	6.5" l x 2.13" w x 3.75" h	7.0 lb	0.26 ft ³	16.5 cm x 5.4 cm x 9.5 cm	3.18 kg	0.01 m ³	6	1
FG500494	Milano in Polished Brass	6.5" l x 2.13" w x 3.75" h	7.0 lb	0.26 ft ³	16.5 cm x 5.4 cm x 9.5 cm	3.18 kg	0.01 m ³	3	1
FG750182	Milano in Polished Brass	6.5" l x 2.13" w x 3.75" h	7.0 lb	0.26 ft ³	16.5 cm x 5.4 cm x 9.5 cm	3.18 kg	0.01 m ³	4	1
FG500565	Milano in Satin Nickel	6.5" l x 2.13" w x 3.75" h	7.0 lb	0.26 ft ³	16.5 cm x 5.4 cm x 9.5 cm	3.18 kg	0.01 m ³	3	1
FG750597	Verona in Polished Chrome	6.75" l x 2.5" w x 5" h	7.0 lb	0.26 ft ³	17.15 cm x 6.35 cm x 12.7 cm	3.18 kg	0.01 m ³	1	1
FG500649	Verona in Polished Chrome	6.75" l x 2.5" w x 5" h	7.0 lb	0.26 ft ³	17.15 cm x 6.35 cm x 12.7 cm	3.18 kg	0.01 m ³	2	1
FG500572	Verona in Polished Chrome	6.75" l x 2.5" w x 5" h	7.0 lb	0.26 ft ³	17.15 cm x 6.35 cm x 12.7 cm	3.18 kg	0.01 m ³	3	1
FG500641	Verona in Polished Chrome	6.75" l x 2.5" w x 5" h	7.0 lb	0.26 ft ³	17.15 cm x 6.35 cm x 12.7 cm	3.18 kg	0.01 m ³	4	1
FG750645	Sienna in Polished Chrome	7" l x 2.25" w x 3.5" h	7.0 lb	0.26 ft ³	17.78 cm x 5.72 cm x 8.89 cm	3.18 kg	0.01 m ³	1	1
FG500574	Sienna in Polished Chrome	7" l x 2.25" w x 3.5" h	7.0 lb	0.26 ft ³	17.78 cm x 5.72 cm x 8.89 cm	3.18 kg	0.01 m ³	3	1
FG500646	Sienna in Polished Chrome	7" l x 2.25" w x 3.5" h	7.0 lb	0.26 ft ³	17.78 cm x 5.72 cm x 8.89 cm	3.18 kg	0.01 m ³	4	1
FG750085	Capri in Polished Chrome	7" l x 2.5" w x 3.5" h	7.0 lb	0.26 ft ³	17.78 cm x 6.35 cm x 8.89 cm	3.18 kg	0.01 m ³	2	1
FG500576	Capri in Polished Chrome	7" l x 2.5" w x 3.5" h	7.0 lb	0.26 ft ³	17.78 cm x 6.35 cm x 8.89 cm	3.18 kg	0.01 m ³	2	1
FG500652	Capri in Polished Chrome	7" l x 2.5" w x 3.5" h	7.0 lb	0.26 ft ³	17.78 cm x 6.35 cm x 8.89 cm	3.18 kg	0.01 m ³	4	1
FG750270	Venetian 3.5" in Polished Chrome	4.85" l x 2" w x 9.4" h	7.0 lb	0.26 ft ³	12.32 cm x 5.08 cm x 23.88 cm	3.18 kg	0.01 m ³	2	1
FG500610	Venetian 3.5" in Polished Chrome	4.85" l x 2" w x 9.4" h	7.0 lb	0.26 ft ³	12.32 cm x 5.08 cm x 23.88 cm	3.18 kg	0.01 m ³	3	1
FG750173	Venetian 3.5" in Polished Chrome	4.85" l x 2" w x 9.4" h	7.0 lb	0.26 ft ³	12.32 cm x 5.08 cm x 23.88 cm	3.18 kg	0.01 m ³	4	1
FG750096	Venetian 5.5" in Polished Chrome	7.63" l x 2" w x 10" h	7.0 lb	0.26 ft ³	19.38 cm x 5.08 cm x 25.4 cm	3.18 kg	0.01 m ³	3	1
FG750354	Venetian 5.5" in Polished Chrome	7.63" l x 2" w x 10" h	7.0 lb	0.26 ft ³	19.38 cm x 5.08 cm x 25.4 cm	3.18 kg	0.01 m ³	4	1

*Supplied with 1.5 GPM (5.7 L/min.) laminar flow; can be ordered with Flow Control Aerator that delivers 0.5 GPM, 1.0 GPM, 1.5 GPM, 2.0 GPM, or 2.2 GPM.



Sienna



Venetian deck-mounted



Venetian wall-mounted

AUTO FAUCET®* 8" CENTER SET

No.	Description	U.S. Dimensions	U.S. Ship Wt/Case	U.S. Case Cube	Metric Dimensions	Metric Ship Wt/Case	Metric Case Cube	Kit	Case Pack
FG500479	Milano in Polished Chrome	6.5" l x 2.13" w x 3.75" h	7.0 lb	0.26 ft³	16.5 cm x 5.4 cm x 9.5 cm	3.18 kg	0.01 m³	1	1
FG500482	Milano in Polished Chrome	6.5" l x 2.13" w x 3.75" h	7.0 lb	0.26 ft³	16.5 cm x 5.4 cm x 9.5 cm	3.18 kg	0.01 m³	2	1
1782744	Milano in Polished Chrome (Low Lead)	6.5" l x 2.13" w x 3.75" h	7.0 lb	0.26 ft³	16.5 cm x 5.4 cm x 9.5 cm	3.18 kg	0.01 m³	3	1
FG500617	Milano in Polished Chrome	6.5" l x 2.13" w x 3.75" h	7.0 lb	0.26 ft³	16.5 cm x 5.4 cm x 9.5 cm	3.18 kg	0.01 m³	4	1
FG500485	Milano in Polished Chrome	6.5" l x 2.13" w x 3.75" h	7.0 lb	0.26 ft³	16.5 cm x 5.4 cm x 9.5 cm	3.18 kg	0.01 m³	6	1
1818986	Milano in Polished Chrome (Low Lead)	6.5" l x 2.13" w x 3.75" h	7.0 lb	0.26 ft³	16.5 cm x 5.4 cm x 9.5 cm	3.18 kg	0.01 m³	3	1
FG500495	Milano in Polished Brass	6.5" l x 2.13" w x 3.75" h	7.0 lb	0.26 ft³	16.5 cm x 5.4 cm x 9.5 cm	3.18 kg	0.01 m³	1	1
FG750183	Milano in Polished Brass	6.5" l x 2.13" w x 3.75" h	7.0 lb	0.26 ft³	16.5 cm x 5.4 cm x 9.5 cm	3.18 kg	0.01 m³	4	1
FG500566	Milano in Satin Nickel	6.5" l x 2.13" w x 3.75" h	7.0 lb	0.26 ft³	16.5 cm x 5.4 cm x 9.5 cm	3.18 kg	0.01 m³	3	1
FG750598	Verona in Polished Chrome	6.75" l x 2.5" w x 5" h	7.0 lb	0.26 ft³	17.15 cm x 6.35 cm x 12.7 cm	3.18 kg	0.01 m³	1	1
FG500573	Verona in Polished Chrome	6.75" l x 2.5" w x 5" h	7.0 lb	0.26 ft³	17.15 cm x 6.35 cm x 12.7 cm	3.18 kg	0.01 m³	3	1
FG500642	Verona in Polished Chrome	6.75" l x 2.5" w x 5" h	7.0 lb	0.26 ft³	17.15 cm x 6.35 cm x 12.7 cm	3.18 kg	0.01 m³	4	1
FG500575	Sienna in Polished Chrome	7" l x 2.25" w x 3.5" h	7.0 lb	0.26 ft³	17.78 cm x 5.72 cm x 12.7 cm	3.18 kg	0.01 m³	3	1
FG500647	Sienna in Polished Chrome	7" l x 2.25" w x 3.5" h	7.0 lb	0.26 ft³	17.78 cm x 5.72 cm x 8.89 cm	3.18 kg	0.01 m³	4	1
FG500577	Capri in Polished Chrome	7" l x 2.5" w x 3.5" h	7.0 lb	0.26 ft³	17.78 cm x 6.35 cm x 8.89 cm	3.18 kg	0.01 m³	3	1
FG500653	Capri in Polished Chrome	7" l x 2.5" w x 3.5" h	7.0 lb	0.26 ft³	17.78 cm x 6.35 cm x 8.89 cm	3.18 kg	0.01 m³	4	1
FG750271	Venetian 3.5" in Polished Chrome	4.85" l x 2" w x 9.4" h	7.0 lb	0.26 ft³	12.32 cm x 5.08 cm x 25.4 cm	3.18 kg	0.01 m³	2	1
FG500611	Venetian 3.5" in Polished Chrome	4.85" l x 2" w x 9.4" h	7.0 lb	0.26 ft³	12.32 cm x 5.08 cm x 25.4 cm	3.18 kg	0.01 m³	3	1
FG750174	Venetian 3.5" in Polished Chrome	4.85" l x 2" w x 9.4" h	7.0 lb	0.26 ft³	12.32 cm x 5.08 cm x 25.4 cm	3.18 kg	0.01 m³	4	1
FG750095	Venetian 5.5" in Polished Chrome	7.63" l x 2" w x 10" h	7.0 lb	0.26 ft³	19.38 cm x 5.08 cm x 25.4 cm	3.18 kg	0.01 m³	3	1
FG750355	Venetian 5.5" in Polished Chrome	7.63" l x 2" w x 10" h	7.0 lb	0.26 ft³	19.38 cm x 5.08 cm x 25.4 cm	3.18 kg	0.01 m³	4	1

* Supplied with 1.5 GPM (5.7 L/min.) laminar flow; can be ordered with Flow Control Aerators that deliver 0.5 GPM, 1.0 GPM, 1.5 GPM, 2.0 GPM, or 2.2 GPM.

AUTO FAUCET®* SINK WALL-MOUNTED FAUCETS^ 4" AND 8" CENTER SET^

No.	Description	U.S. Dimensions	U.S. Ship Wt/Case	U.S. Case Cube	Metric Dimensions	Metric Ship Wt/Case	Metric Case Cube	Kit	Case Pack
FG750607	Venetian 3.5 Polished Chrome Wall Mount 4" Center Set	14.5" l x 10" w x 6" h	8.0 lb	0.5 ft³	36.8 cm x 25.4 cm x 15.2 cm	3.6 kg	0.01 m³	2	1
FG750613	Venetian 3.5 Polished Chrome Wall Mount 4" Center Set	14.5" l x 10" w x 6" h	8.0 lb	0.5 ft³	36.8 cm x 25.4 cm x 15.2 cm	3.6 kg	0.01 m³	4	1
FG750605	Venetian 5.5 Polished Chrome Wall Mount 4" Center Set	14.5" l x 10" w x 6" h	8.0 lb	0.5 ft³	36.8 cm x 25.4 cm x 15.2 cm	3.6 kg	0.01 m³	3	1
FG750602	Venetian 5.5 Polished Chrome Wall Mount 4" Center Set	14.5" l x 10" w x 6" h	8.0 lb	0.5 ft³	36.8 cm x 25.4 cm x 15.2 cm	3.6 kg	0.01 m³	4	1
FG750612	Venetian 3.5 Polished Chrome Wall Mount 8" Center Set	14.5" l x 10" w x 6" h	9.0 lb	0.5 ft³	36.8 cm x 25.4 cm x 15.2 cm	4.1 kg	0.01 m³	2	1
FG750608	Venetian 3.5 Polished Chrome Wall Mount 8" Center Set	17.75" l x 10" w x 7" h	9.0 lb	0.72 ft³	45.1 cm x 25.4 cm x 17.8 cm	4.1 kg	0.02 m³	4	1
FG750604	Venetian 5.5 Polished Chrome Wall Mount 8" Center Set	14.5" l x 10" w x 6" h	9.0 lb	0.5 ft³	36.8 cm x 25.4 cm x 15.2 cm	4.1 kg	0.01 m³	3	1
FG750600	Venetian 5.5 Polished Chrome Wall Mount 8" Center Set	14.5" l x 10" w x 6" h	8.0 lb	0.5 ft³	36.8 cm x 25.4 cm x 15.2 cm	3.6 kg	0.01 m³	4	1

^Supplied with 2.2 GPM (10.0 L/min.) laminar flow; can be ordered with Flow Control Aerators that deliver 1.5 GPM or 2.2 GPM.

^Sink Wall-Mounted Faucets require three mounting holes.

Kit 1 includes: spout and valve control module

Kit 2 includes: spout, valve control module, and main supply hose (1/2" pipe x 3/8" comp. x 12" length)

Kit 3 includes: spout, valve control module, mixing valve, and hot/cold supply hoses (3/8" comp x 3/8" comp. x 12" length)

Kit 4 includes: spout, valve control module, thermostatic mixing valve, and hot/cold supply hoses (3/8" comp x 3/8" comp. x 12" length)

Kit 5 includes: spout, valve control module, mixing valve, and hot/cold supply hoses (3/8" comp x 1/2" comp. x 12" length)

Kit 6 includes: 0.5 GPM spout, valve control module, mixing valve, and hot/cold supply hoses (3/8" comp x 3/8" comp. x 12" length)

Auto Flush® Systems

Touch-free, cost-effective flushing systems.

- Smart Object Infrared Technology manages flushing automation for world-class reliability
- Dry-cam technology ensures reliable performance and eliminates costly repairs and fixture downtime
- Promotes good hygiene by eliminating potential points of cross-contamination
- Prevents odors by ensuring that fixtures are flushed after every use
- No water shutoff is required during installation
- Auto Flush® Systems are available for toilets and urinals
- Installs in minutes



ADA COMPLIANT

Auto Flush® Sidemount

Ensures toilets and urinals are always flushed and presentable.

- Eliminates source of odor
- Battery reserve feature allows 9,000 flushes after low-battery indicator begins flashing
- Angled lens design combined with advanced sensor technology guarantees activation even with the toilet seat raised
- Toilet and urinal models available; toilet model has courtesy flush button to ensure fixtures are flushed at least once per day to keep traps primed
- Long battery life, 3+ years or up to 100,000 flushes



AUTO FLUSH® SIDEMOUNT (FOR SLOAN OR ZURN FLUSH VALVES)

No.	Description	U.S. Dimensions	U.S. Ship Wt/Case	U.S. Case Cube	Metric Dimensions	Metric Ship Wt/Case	Metric Case Cube	Case Pack
FG401186A	Auto Flush® Sidemount Polished Chrome Urinal	4.75" l x 3.3" w x 2.8" h	2.3 lb	0.15 ft³	12 cm x 8.38 cm x 7.11 cm	1.04 kg	0.004 m³	1
FG401187A	Auto Flush® Sidemount Polished Chrome Toilet	4.75" l x 3.3" w x 2.8" h	2.3 lb	0.15 ft³	12 cm x 8.38 cm x 7.11 cm	1.04 kg	0.004 m³	1
FG401981	Auto Flush® Sidemount Polished Chrome Toilet – Metal	4.75" l x 3.3" w x 2.8" h	2.3 lb	0.15 ft³	12 cm x 8.38 cm x 7.11 cm	1.04 kg	0.004 m³	1
FG401982	Auto Flush® Sidemount Polished Chrome Urinal – Metal	4.75" l x 3.3" w x 2.8" h	2.3 lb	0.15 ft³	12 cm x 8.38 cm x 7.11 cm	1.04 kg	0.004 m³	1

AUTO FLUSH® SIDEMOUNT (FOR COYNE & DELANY FLUSHBOY VALVES)

No.	Description	U.S. Dimensions	U.S. Ship Wt/Case	U.S. Case Cube	Metric Dimensions	Metric Ship Wt/Case	Metric Case Cube	Case Pack
FG401207A	Auto Flush® Sidemount Polished Chrome Urinal	4.75" l x 3.3" w x 2.8" h	2.3 lb	0.15 ft³	12 cm x 8.38 cm x 7.11 cm	1.04 kg	0.004 m³	1
FG401206A	Auto Flush® Sidemount Polished Chrome Toilet	4.75" l x 3.3" w x 2.8" h	2.3 lb	0.15 ft³	12 cm x 8.38 cm x 7.11 cm	1.04 kg	0.004 m³	1

AUTO FLUSH® SIDEMOUNT ADAPTERS

No.	Description	U.S. Dimensions	U.S. Ship Wt/Case	U.S. Case Cube	Metric Dimensions	Metric Ship Wt/Case	Metric Case Cube	Case Pack
401096	Auto Flush® High-Mount Adapter Kit	4.75" l x 3.3" w x 2.8" h	2.3 lb	0.15 ft³	12 cm x 8.38 cm x 7.11 cm	1.04 kg	0.004 m³	1
401165	Auto Flush® Crane Valve Adapter Kit	4.75" l x 3.3" w x 2.8" h	2.3 lb	0.15 ft³	12 cm x 8.38 cm x 7.11 cm	1.04 kg	0.004 m³	1
401239	Auto Flush® Teck Valve Adapter	4.75" l x 3.3" w x 2.8" h	2.3 lb	0.15 ft³	12 cm x 8.38 cm x 7.11 cm	1.04 kg	0.004 m³	1
401477	Auto Flush® Tempus Valve Adapter	4.75" l x 3.3" w x 2.8" h	2.3 lb	0.15 ft³	12 cm x 8.38 cm x 7.11 cm	1.04 kg	0.004 m³	1

Auto Flush® Clamp

Easy installation automates flush handles in minutes.

- Courtesy flush option prevents sewer gas buildup
- Audio tone option indicates low batteries
- Adjustable sensor range
- Long battery life, 3+ years or up to 60,000 flushes (4 C batteries included)



Simply slides over existing handle.

FG401805A
Toilet



FG401804A
Urinal



No.	Description	U.S. Dimensions	U.S. Ship Wt/Case	U.S. Case Cube	Metric Dimensions	Metric Ship Wt/Case	Metric Case Cube	Case Pack
FG401804A	Auto Flush® Clamp Polished Chrome Urinal	5.313" l x 3.56" w x 3.63" h	1.5 lb	0.14 ft³	13.5 cm x 9.04 cm x 9.22 cm	0.68 kg	0.004 m³	1
FG401805A	Auto Flush® Clamp Polished Chrome Toilet	5.313" l x 3.56" w x 3.63" h	1.5 lb	0.14 ft³	13.5 cm x 9.04 cm x 9.22 cm	0.68 kg	0.004 m³	1
FG402060A	Auto Flush® Clamp Polished Chrome Urinal – Metal	5.313" l x 3.56" w x 3.63" h	1.5 lb	0.14 ft³	13.5 cm x 9.04 cm x 9.22 cm	0.68 kg	0.004 m³	6
FG402059A	Auto Flush® Clamp Polished Chrome Toilet – Metal	5.313" l x 3.56" w x 3.63" h	1.5 lb	0.14 ft³	13.5 cm x 9.04 cm x 9.22 cm	0.68 kg	0.004 m³	1

*Requires 4 C alkaline batteries (included).

AUTO FLUSH® CLAMP ADAPTERS

No.	Description	U.S. Dimensions	U.S. Ship Wt/Case	U.S. Case Cube	Metric Dimensions	Metric Ship Wt/Case	Metric Case Cube	Case Pack
401972	Auto Flush® Coyne & Delany/Crane Rex Adapter Kit	5.313" l x 3.56" w x 3.63" h	1.5 lb	0.14 ft³	13.5 cm x 9.04 cm x 9.22 cm	0.68 kg	0.004 m³	1
FG401979	Auto Flush® Sloan Gem Adapter Kit	5.313" l x 3.56" w x 3.63" h	1.5 lb	0.14 ft³	13.5 cm x 9.04 cm x 9.22 cm	0.68 kg	0.004 m³	1
FG401980	Auto Flush® Toto Adapter Kit	5.313" l x 3.56" w x 3.63" h	1.5 lb	0.14 ft³	13.5 cm x 9.04 cm x 9.22 cm	0.68 kg	0.004 m³	1
401973	Auto Flush® Canadian Adapter Kit (Crane, Teck, Tempus)	5.313" l x 3.56" w x 3.63" h	1.5 lb	0.14 ft³	13.5 cm x 9.04 cm x 9.22 cm	0.68 kg	0.004 m³	1
4870577	Auto Flush® Power Adapter Kit	5.313" l x 3.56" w x 3.63" h	1.5 lb	0.14 ft³	13.5 cm x 9.04 cm x 9.22 cm	0.68 kg	0.004 m³	1

Auto Flush® Tank

Touch-free wireless tank toilet flushing system. Easy installation—simply mount the motor in the tank, install sensor, and insert batteries.

- Ensures toilets are always flushed and presentable
- Wireless sensor located directly behind the washroom patron guarantees activation even if the toilet seat is raised
- Three modes of operation: object detection, object detection with extended delay, and wave only
- Fits most tank styles and displaces little water
- Long battery life, 3+ years or 100,000 flushes (4 D batteries included)



Mount motor in tank and attach to flapper.

No.	Description	U.S. Dimensions	U.S. Ship Wt/Case	U.S. Case Cube	Metric Dimensions	Metric Ship Wt/Case	Metric Case Cube	Case Pack
FG750831	Auto Flush® Tank White	1.92" l x 1.71" w x 1" h	3.0 lb	1.25 ft³	4.9 cm x 4.3 cm x 2.5 cm	1.4 kg	0.04 m³	1

*Requires 4 D alkaline batteries (included).

ecoUrinal™

ecoUrinal™ features a unique cartridge making it the most effective and ecological water-free urinal system available. ecoUrinal™ is easy to maintain and helps facilities save on operating costs while supporting their sustainability initiatives.

- One ecoUrinal™ conserves an average of 40,000 gallons of water each year
- Water-free system also helps eliminate costly flush valve repairs and prevents cleanups caused by overflowed fixtures
- ecoUrinal™ can be retrofitted at the same height as traditional urinals; installation doesn't require any flush valve assembly or water supply hookup and only takes an hour to install



HALF-STALL URINAL WITH LARGE BASIN IS MANUFACTURED FROM VITREOUS CHINA WITH WHITE FINISH

INNOVATIVE CARTRIDGE lasts up to **10 YEARS**

Eliminates the need to replace liquid sealant or cartridges that other water-free systems require, plus ease of cleaning the system allows for greater worker productivity.

ecoUrinal™ Fixture Features:

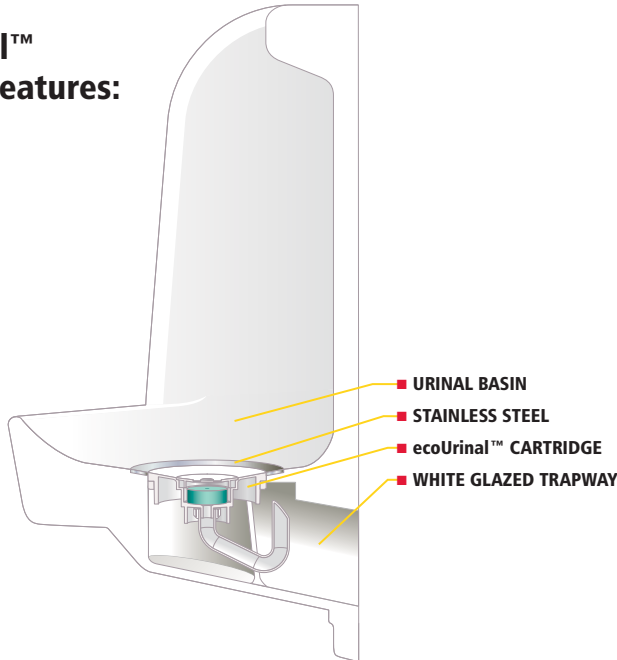

ecoUrinal™ Cartridge Features:

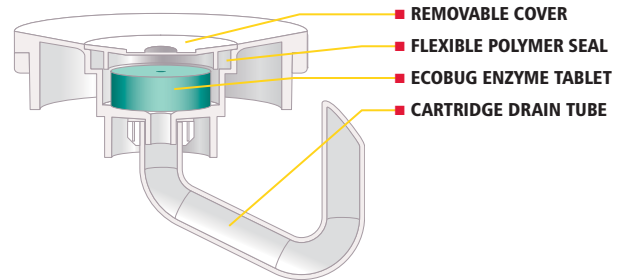

No.	Description	U.S. Dimensions	U.S. Ship Wt/Case	U.S. Case Cube	Metric Dimensions	Metric Ship Wt/Case	Metric Case Cube	Case Pack
FG751220*	ecoUrinal™	14" l x 19.38" w x 26.13" h	55 lb	5.16 ft³	35.56 cm x 49.23 cm x 66.37 cm	24.95 kg	.15 m³	1
FG4870052	ecoUrinal™ Cartridge	N/A	0.2 lb	N/A	N/A	0.09 kg	N/A	1
FG4870053	Urinal Cartridge Tool	N/A	0.2 lb	N/A	N/A	0.09 kg	N/A	1
FG4870108	ecoBug – Enzyme Tablet	2" l x 2" w x 1" h	0.4 lb	0.01 ft³	5.08 cm x 5.08 cm x 2.54 cm	0.18 kg	0.0 m³	6
FG4870109	ecoBug – Enzyme Tablet	2" l x 2" w x 1" h	0.7 lb	0.02 ft³	5.08 cm x 5.08 cm x 2.54 cm	0.31 kg	0.0 m³	12

*751220 includes: Urinal Body, Cartridge, Wall Hanger Brackets (2), Wall Anchors (6), Screws (6), Washers (8), Brass Urinal Flange.

SaniCell™

SaniCell™ automatic cleaning systems effectively clean toilets and urinals around the clock.

- Extends time between manual cleaning cycles
- Installs directly into the water line, so the Purinel® SC formula travels everywhere water does to more effectively clean fixture surfaces
- Controls the amount of cleaning chemicals entering the waste stream, saving you money on cleaning supplies
- Water shutoff is not required during installation



REDUCE CLEANING TIME by up to

50%

Improves Image

Ensures washroom fixtures are always clean and presentable and eliminates up to 99.99% of odor-causing bacteria.

Low-Cost Maintenance

Durable design features smooth surface for easy cleaning and keyed lid to help prevent tampering.



4870476 / 4870479

SaniCell™ Tank

The SaniCell™ Tank system discreetly installs inside tank toilets and continuously cleans without batteries or moving parts.

- Compact system installs in almost any tank toilet in minutes
- Latching cover provides watertight seal



SaniCell™ Pipe

The SaniCell™ Pipe system is designed to clean toilets and urinals, enhancing the image of away-from-home washrooms.

- Durable design features smooth surface for easy cleaning
- Keyed lid helps prevent tampering
- Polished chrome finish matches existing plumbing
- Reliable performance: battery-free operation and no electronics or moving parts



FG750375



SANICELL™ PIPE AND TANK DISPENSERS

No.	Description	U.S. Dimensions	U.S. Ship Wt./Case	U.S. Case Cube	Metric Dimensions	Metric Ship Wt./Case	Metric Case Cube	Case Pack
4870476	SaniCell™ Pipe with ¾" Connector – Chrome	3.3" l x 5.8" w x 5" h	4.51 lb	0.38 ft³	8.4 cm x 14.7 cm x 12.7 cm	2.04 kg	0.01 m³	6
4870479	SaniCell™ Pipe with 1½" and 1½" Connectors – Chrome	3.3" l x 5.8" w x 5" h	4.51 lb	0.38 ft³	8.4 cm x 14.7 cm x 12.7 cm	2.04 kg	0.01 m³	6
FG750375	SaniCell™ Tank – Clear	1.38" l x 1.06" w x 1" h	1.0 lb	0.61 ft³	3.5 cm x 2.7 cm x 2.5 cm	2.04 kg	0.01 m³	12

SANICELL™ PIPE & AUTOFLUSH™ BUNDLE PACKS

No.	Description	U.S. Dimensions	U.S. Ship Wt./Case	U.S. Case Cube	Metric Dimensions	Metric Ship Wt./Case	Metric Case Cube	Case Pack
3486552	SaniCell™ Pipe and AutoFlush™ Sidemount (Toilet)	3.3" l x 5.8" w x 5" h	3.2 lb	0.21 ft³	8.4 cm x 14.7 cm x 12.7 cm	1.45 kg	0.01 m³	1
3486553	SaniCell™ Pipe and AutoFlush™ Sidemount (Urinal)	3.3" l x 5.8" w x 5" h	3.2 lb	0.21 ft³	8.4 cm x 14.7 cm x 12.7 cm	1.45 kg	0.01 m³	1
3486554	SaniCell™ Pipe and AutoFlush™ Clamp (Toilet)	1.38" l x 1.06" w x 1" h	3.2 lb	0.21 ft³	3.5 cm x 2.7 cm x 2.5 cm	1.45 kg	0.01 m³	1
3486555	SaniCell™ Pipe and AutoFlush™ Clamp (Urinal)	1.38" l x 1.06" w x 1" h	3.2 lb	0.21 ft³	3.5 cm x 2.7 cm x 2.5 cm	1.45 kg	0.01 m³	1

Urinal Packs: ¾" SaniCell™ Pipe and AutoFlush; Toilet Packs: 1½" and 1½" SaniCell Pipe and AutoFlush with Courtesy Flush Button

SaniCell™ Wall

SaniCell™ Wall systems feature continuous Purinel® SC cleaning in either LED* or Service (battery-free) dispensers.

- Refill indicator LED flashes red when it's time to replace the refill and yellow to indicate low batteries (*requires two AA batteries, included)
- Available in four contemporary color combinations to enhance washroom image and match any décor
- Cleans both toilets and urinals



Refilling is easy—just drop, twist, and click!



4870488 /
4870492



4870487 /
4870491



4870485 /
4870489

4870486 /
4870490

SANICELL™ WALL DISPENSERS & ACCESSORIES

No.	Description	U.S. Dimensions	U.S. Ship Wt/Case	U.S. Case Cube	Metric Dimensions	Metric Ship Wt/Case	Metric Case Cube	Case Pack
4870485	SaniCell™ Wall Service – White/White	3.1" l x 4.2" w x 7.6" h	4.18 lb	0.505 ft³	7.9 cm x 10.7 cm x 19.3 cm	1.9 kg	0.10 m³	6
4870486	SaniCell™ Wall Service – White/Gray	3.1" l x 4.2" w x 7.6" h	4.18 lb	0.505 ft³	7.9 cm x 10.7 cm x 19.3 cm	1.9 kg	0.10 m³	6
4870487	SaniCell™ Wall Service – Black/Black	3.1" l x 4.2" w x 7.6" h	4.18 lb	0.505 ft³	7.9 cm x 10.7 cm x 19.3 cm	1.9 kg	0.10 m³	6
4870488	SaniCell™ Wall Service – Black/Chrome	3.1" l x 4.2" w x 7.6" h	4.18 lb	0.505 ft³	7.9 cm x 10.7 cm x 19.3 cm	1.9 kg	0.10 m³	6
4870489	SaniCell™ Wall LED – White/White	3.1" l x 4.2" w x 7.6" h	4.18 lb	0.505 ft³	7.9 cm x 10.7 cm x 19.3 cm	1.9 kg	0.10 m³	6
4870490	SaniCell™ Wall LED – White/Black	3.1" l x 4.2" w x 7.6" h	4.18 lb	0.505 ft³	7.9 cm x 10.7 cm x 19.3 cm	1.9 kg	0.10 m³	6
4870491	SaniCell™ Wall LED – Black/Black	3.1" l x 4.2" w x 7.6" h	4.18 lb	0.505 ft³	7.9 cm x 10.7 cm x 19.3 cm	1.9 kg	0.10 m³	6
4870492	SaniCell™ Wall LED – Black/Chrome	3.1" l x 4.2" w x 7.6" h	4.18 lb	0.505 ft³	7.9 cm x 10.7 cm x 19.3 cm	1.9 kg	0.10 m³	6
4870504	¾" Connection Kit	N/A	4.5 lb	0.17 ft³	N/A	2.05 kg	0.0 m³	6
4870505	1½" Connection Kit	N/A	4.5 lb	0.17 ft³	N/A	2.05 kg	0.0 m³	6
4870506	1½" Connection Kit	N/A	4.5 lb	0.17 ft³	N/A	2.05 kg	0.0 m³	6
4870509	12½" Stainless Steel Tube	N/A	0.20 lb	0.17 ft³	N/A	0.9 kg	0.0 m³	6
4870510	24" x 8" Stainless Steel Tube	N/A	0.50 lb	0.16 ft³	N/A	0.22 kg	0.0 m³	6
4870511	Hand Drill Kit	N/A	0.75 lb	0.02 ft³	N/A	0.34 kg	0.0 m³	1
4012902T	Drip Delivery Kit	N/A	0.42 lb	0.64 ft³	N/A	0.19 kg	0.02 m³	12

Purinel® SC Refills

Super-concentrated Purinel® SC cleans and maintains fixtures with every flush, even in hard-to-reach areas such as under the rim.

- Kills 99.99% of odor-causing bacteria
- Prevents buildup of hard water deposits on fixture surfaces
- Maintains drains by preventing uric scale buildup, keeping pipes clear and fixtures operating
- 30-, 45-, or 60-day settings extend the time between manual cleaning cycles

PURINEL® SC KILLS
99.99%
of odor-causing
BACTERIA



3485848
Blue

PURINEL® SC REFILLS FOR SANICELL™ WALL SYSTEMS

No.	Description	Capacity	U.S. Ship Wt/Case	U.S. Case Cube	Metric Ship Wt/Case	Metric Case Cube	Case Pack
3485847	Purinel® SC Refill – Clear	60 ml	1.66 lb	0.1 ft³	0.75 kg	0.01 m³	6
3485848	Purinel® SC Refill – Blue	60 ml	1.66 lb	0.1 ft³	0.75 kg	0.01 m³	6

AutoClean®

AutoClean® systems deliver powerful formulas that attack and eliminate odors at the source—automatically cleaning fixture surfaces, day and night.

- Easy in-line installation allows cleaning solution to reach the hard-to-clean areas, such as rim holes, ensuring that the whole fixture is cleaned
- Easy drill-through chrome connection kit; no need to shut off water
- Refills deliver consistent metered dosage of Purinel® SC to prevent buildup of calcium on pipes and scaling
- Flexible programming options: up to 90 day refill cycle settings
- Industry-leading battery life of up to 3 years



ADA COMPLIANT



AUTOCLEAN® DISPENSERS

No.	Description	U.S. Dimensions	U.S. Ship Wt/Case	U.S. Case Cube	Metric Dimensions	Metric Ship Wt/Case	Metric Case Cube	Case Pack
FG500590	AutoClean® LCD Dispenser – Chrome (Kit w/ 3/4" Connector)	10.27" l x 19.21" w x 8.46" h	4.0 lb	0.06 ft³	26.1 cm x 48.5 cm x 21.5 cm	1.8 kg	0.002 m³	6
FG500591	AutoClean® LCD Dispenser – Chrome (Kit w/ 1/4" Connector)	10.27" l x 19.21" w x 8.46" h	4.0 lb	0.06 ft³	26.1 cm x 48.5 cm x 21.5 cm	1.8 kg	0.002 m³	6
FG500592	AutoClean® LCD Dispenser – Chrome (Kit w/ 1/4" Connector)	10.27" l x 19.21" w x 8.46" h	4.0 lb	0.06 ft³	26.1 cm x 48.5 cm x 21.5 cm	1.8 kg	0.002 m³	6
FG500409	AutoClean® LED Dispenser – Chrome (Kit w/ 3/4" Connector)	12.5" l x 1.25" w x 6.75" h	4.0 lb	0.23 ft³	31.8 cm x 3.2 cm x 17.1 cm	1.8 kg	0.01 m³	1
FG500408	AutoClean® LED Dispenser – Chrome (Kit w/ 1/4" Connector)	12.5" l x 1.25" w x 6.75" h	4.0 lb	0.19 ft³	31.8 cm x 3.2 cm x 17.1 cm	1.8 kg	0.01 m³	1
FG500410	AutoClean® LED Dispenser – Chrome (Kit w/ 1/4" Connector)	12.5" l x 1.25" w x 6.75" h	4.0 lb	0.24 ft³	31.8 cm x 3.2 cm x 17.1 cm	1.8 kg	0.01 m³	1
FG500476	AutoClean® Service Dispenser – Chrome (Kit w/ 3/4" Connector)	12.5" l x 1.25" w x 6.75" h	4.0 lb	0.06 ft³	31.8 cm x 3.2 cm x 17.1 cm	1.8 kg	0.002 m³	1
FG500475	AutoClean® Service Dispenser – Chrome (Kit w/ 1/4" Connector)	12.5" l x 1.25" w x 6.75" h	4.0 lb	0.06 ft³	31.8 cm x 3.2 cm x 17.1 cm	1.8 kg	0.002 m³	1
FG500477	AutoClean® Service Dispenser – Chrome (Kit w/ 1/4" Connector)	12.5" l x 1.25" w x 6.75" h	4.0 lb	0.21 ft³	31.8 cm x 3.2 cm x 17.1 cm	1.8 kg	0.01 m³	1

*Kits contain: AutoClean® Dispenser, Mounting Hardware, Batteries, Connection Kit, and Stainless Steel Connection Tube.

AUTOCLEAN® REFILLS

No.	Description	U.S. Ship Wt/Case	U.S. Case Cube	Metric Ship Wt/Case	Metric Case Cube	Case Pack
FG400586	Purinel® – Drain Maintainer and Cleaner	1.0 lb	0.19 ft³	0.5 kg	0.01 m³	6
FG401591	AutoClean® Cleaner and Deodorizer Refill – Linen Fresh™	1.0 lb	0.21 ft³	0.5 kg	0.01 m³	6
FG401532	AutoClean® Cleaner and Deodorizer Refill – Mandarin Orange	1.0 lb	0.19 ft³	0.5 kg	0.01 m³	6
FG401533	AutoClean® Cleaner and Deodorizer Refill – Vita Splash™	1.0 lb	0.24 ft³	0.5 kg	0.01 m³	6

AutoJanitor®

AutoJanitor® cleans and deodorizes toilets and urinals while providing a clean fresh scent for the restroom.

- Programmable dispenser operates round-the-clock automatically cleaning fixture surfaces, day and night, at 15-, 30-, or 60-day refill cycles
- Concentrated foaming action cleans and reduces bacteria growth everywhere the water goes
- AutoJanitor® BioFlush® formula is enzyme-based to help prevent scale buildup in drain pipes



1793506



AUTOJANITOR® DISPENSER AND ACCESSORIES

No.	Description	U.S. Dimensions	U.S. Ship Wt/Case	U.S. Case Cube	Metric Dimensions	Metric Ship Wt/Case	Metric Case Cube	Case Pack
1793505	AutoJanitor® LED Dispenser – Black	5.51" l x 4.13" w x 10.67" h	4.51 lb	0.031 ft³	4.9 cm x 4.2 cm x 5.1 cm	2.1 kg	0.03 m³	6
1793506	AutoJanitor® LED Dispenser – White	5.51" l x 4.13" w x 10.67" h	4.51 lb	0.031 ft³	4.9 cm x 4.2 cm x 5.1 cm	2.1 kg	0.03 m³	6
1793507	AutoJanitor® LED Dispenser – Chrome	5.51" l x 4.13" w x 10.67" h	4.51 lb	0.031 ft³	4.9 cm x 4.2 cm x 5.1 cm	2.1 kg	0.03 m³	6
401290ZT	Drip Delivery Kit	N/A	0.42 lb	0.64 ft³	N/A	0.19 kg	0.02 m³	12

AUTOJANITOR® REFILLS

No.	Description	U.S. Ship Wt/Case	U.S. Case Cube	Metric Ship Wt/Case	Metric Case Cube	Case Pack
FG400978	AutoJanitor® Cleaner and Deodorizer Refill – Linen Fresh™	11 lbs	0.42 ft³	5.0 kg	0.01 m³	6
FG400980	AutoJanitor® Cleaner and Deodorizer Refill – Mandarin Orange	11 lbs	0.33 ft³	5.0 kg	0.01 m³	6
FG400982	AutoJanitor® Cleaner and Deodorizer Refill – Country Delight™	11 lbs	0.33 ft³	5.0 kg	0.01 m³	6
FG400055	AutoJanitor® BioFlush® Drain Maintenance Refill	11 lbs	0.36 ft³	5.0 kg	0.01 m³	6

Clean Seat

Clean Seat foam and spray toilet seat and handle cleaners provide an added level of personal hygiene to washroom users.

- Antimicrobial Push Bar with Silver-Ion Technology reduces cross-contamination
- Foam refill dispenses 1000 shots of 0.4 ml per dose; spray refill dispenses 2000 shots of 0.2 ml per dose
- Alcohol-based solution removes dirt and bacteria and eliminates the need for messy and awkward seat covers



FG402310



FG450033



Just spray the solution on a toilet tissue, and then wipe the surfaces clean. Handle and seat are hygienic and ready for use in seconds.



ADA COMPLIANT

CLEAN SEAT DISPENSERS

No.	Description	U.S. Dimensions	U.S. Ship Wt/Case	U.S. Case Cube	Metric Dimensions	Metric Ship Wt/Case	Metric Case Cube	Case Pack
FG402310	Clean Seat Foam 400 mL Dispenser – White	5.5" l x 4.75" w x 8" h	12.0 lb	1.8 ft³	14 cm x 12.1 cm x 20.3 cm	5.4 kg	0.05 m³	12
FG450008	Clean Seat Soap Spray 400 mL Dispenser – White	4.3" l x 3.7" w x 8.25" h	11.4 lb	1.9 ft³	10.9 cm x 9.4 cm x 21 cm	0.5 kg	0.05 m³	12
FG450033	Clean Seat Soap Spray 400 mL Dispenser – Black	4.3" l x 3.7" w x 8.25" h	11.4 lb	1.9 ft³	10.9 cm x 9.4 cm x 21 cm	0.5 kg	0.05 m³	12

CLEAN SEAT REFILLS

No.	Description	U.S. Size	U.S. Ship Wt/Case	U.S. Case Cube	Metric Ship Wt/Case	Metric Case Cube	Case Pack
FG402312	Clean Seat Foaming Refill	400 ml	11.9 lb	0.47 ft³	0.5 kg	0.01 m³	12
FG402537	Clean Seat Spray Refill	400 ml	11.0 lb	0.41 ft³	0.5 kg	0.01 m³	12



AUTO DOOR™

Accommodates left- & right-hand swing doors, as well as latching- and nonlatching doors. Retracting arm not connected to door.

Auto Door™

Complete the Touch-Free Washroom experience with the Auto Door™ Opener. Patrons no longer need to use towels, tissues, or shirtsleeves when opening the door! The Auto Door's sleek, compact design effortlessly automates an otherwise manual door.



ADA COMPLIANT

- Eliminates points of cross-contamination
- Provides ADA compliance
- Delivers user-friendly and reliable automation
- Improves health and wellness in your facility
- Low energy operation



1800382

AUTO DOOR™ SENSOR

Touch-free sensor detects hand motion to activate door opening mechanism.

No.	Description	U.S. Dimensions	U.S. Ship Wt/Case	U.S. Case Cube	Metric Dimensions	Metric Ship Wt/Case	Metric Case Cube	Case Pack
1800381	Auto Door™	27" l x 7" w x 12.38" h	20.2 lb	n/a	60.96 cm x 17.8 cm x 31.2 cm	9 kg	0.22 m ³	1
1800382	Auto Door™ Sensor	5.38" l x 4.88" w x 1.25" h	0.9 lb	n/a	13.7 cm x 12.4 cm x 2.8 cm	0.4 kg	0.19 m ³	1
1800383	Auto Door™ Sensor Extension Cable	5" l x 5" w x .75" h	0.4 lb	n/a	13.7 cm x 12.7 cm x 1.9 cm	0.18 kg	0.04 m ³	1
1800384	Auto Door™ Electric Strike	6" l x 4" w x 2" h	0.75 lb	n/a	15.2 cm x 10.2 cm x 5.1 cm	0.34 kg	0.04 m ³	1

*Date subject to change.

Sanitary Bin

Designed to provide a safe and hygienic way to dispose of sanitary waste.

- Deep chute prevents waste adhesion and promotes better hygiene
- Dry system bins are lined so the interior is never soiled
- Pedal operation limits direct contact
- Smooth contoured shape does not harbor dirt or germs and is easy to clean



FG402348



FG402413
5 Gallon

FG750244
3 Gallon

SaniSense Bin Deodorizer™ activates when waste is placed in the bin.

No.	Description	U.S. Dimensions	U.S. Ship Wt/Case	U.S. Case Cube	Metric Dimensions	Metric Ship Wt/Case	Metric Case Cube	Case Pack
FG402338	Sanitary Bin 5 Gallon – White	20.75" l x 6.125" w x 22.625" h	26.4 lb	7.6 ft³	52.7 cm x 15.6 cm x 57.5 cm	12.0 kg	0.22 m³	4
FG402413	Sanitary Bin 5 Gallon – Gray	20.75" l x 6.125" w x 22.625" h	26.4 lb	7.6 ft³	52.7 cm x 15.6 cm x 57.5 cm	12.0 kg	0.22 m³	4
FG750243	Sanitary Bin 3 Gallon – White	17.5" l x 5.625" w x 18.625" h	5.1 lb	1.3 ft³	44.5 cm x 14.3 cm x 47.3 cm	2.3 kg	0.04 m³	1
FG750244	Sanitary Bin 3 Gallon – Gray	17.5" l x 5.625" w x 18.625" h	5.1 lb	1.3 ft³	44.5 cm x 14.3 cm x 47.3 cm	2.3 kg	0.04 m³	1
FG402348	SaniSense Bin Deodorizer™	N/A	29.0 lb	0.92 ft³	N/A	13.2 kg	0.03 m³	12
FG402339	Sanitary Bin 5-Gallon Liners – 15 per roll	N/A	6.8 lb	0.34 ft³	N/A	3.1 kg	0.01 m³	25
FG750443	Sanitary Bin 3-Gallon Liners – 15 per roll	N/A	6.8 lb	0.34 ft³	N/A	3.1 kg	0.01 m³	25

Sanitary Napkin Receptacles

Space-saving and easy to service.

- Tight-fitting lids help contain odors
- Removable rigid liner is easy to clean and maintain
- Durable plastic and metal receptacles



FG614000



FG614100



FG11SS



FG10



FG135

No.	Color	Description	U.S. Dimensions	U.S. Ship Wt/Ctn	Metric Dimensions	Metric Ship Wt/Ctn	Material Type	Pack
FG614000	WHT	Sanitary Napkin Receptacle with Rigid Liner	10.75" l x 5.25" w x 12.5" h	2.6 lb	27.3 cm x 13.3 cm x 31.8 cm	1.2 kg	Plastic	1
FG614100	0000	Waxed Bags for Sanitary Napkin Receptacle 50 bags/bundle; 250 per carton	8.75" l x 8.5" h	6.2 lb	22.2 cm x 21.6 cm	2.8 kg		1/250
FG10	WHT	Sanitary Napkin Wall-Mount with Drop Bottom	8.75" l x 4.5" w x 11" h	4.0 lb	22.2 cm x 11.4 cm x 27.9 cm	1.8 kg	Powder-Coated	1
FG11	SSSTL	Sanitary Napkin Wall-Mount with Drop Bottom includes (3) FG614100 Waxed Bags	5.75" dia x 9.25" l x 11" h	3 lb	14.6 cm dia x 23.5 cm x 27.9 cm	1.4 kg	Stainless Steel	1
FG13	WHT	Double Stall Sanitary Napkin with Foot Pedals includes (3) 1781466 Waxed Bags	9.75" dia x 9.25" l x 11" h	9 lb	24.8 cm dia x 23.5 cm x 27.9 cm	4.1 kg	Powder-Coated	1
FG135	WHT	Single Stall Sanitary Napkin with Foot Pedals includes (3) FG614100 Waxed Bags	5" dia x 10" l x 11" h	6 lb	12.7 cm dia x 25.4 cm x 27.9 cm	2.7 kg	Powder-Coated	1
1781466	N/A	Waxed Bag for FG13	9.25" dia x 6.75" l x 12" h	18 lb	23.5 cm dia x 17.1 cm x 30.5 cm	8.1 kg	N/A	500

Baby Changing Stations with Antimicrobial Protection

Horizontal and vertical baby changing stations meet all global safety standards (ASTM, ADA, and EN).

- Antimicrobial protection
- Easy-reach hooks
- Built-in shelf and liner storage



FG781888



FG781988

No.	Color	Description	U.S. Dimensions	U.S. Ship Wt/Ctn	Metric Dimensions	Metric Ship Wt/Ctn	Pack
FG781788	WHT	Protective Liners for Baby Changing Stations, Laminated 2-Ply Tissue Paper	13.25" l x 5.5" w	4.8 lb	33.7 cm x 14 cm	2.2 kg	1/320 Ctn
FG781888	LPLAT	Baby Changing Station Horizontal	33.25" l x 21.5" w x 4" h	23.5 lb	84.5 cm x 54.6 cm x 10.2 cm	10.7 kg	1
FG781988	LPLAT	Baby Changing Station Vertical	23" l x 34.1" w x 4" h	25.0 lb	58.4 cm x 86.6 cm x 10.2 cm	11.3 kg	1

Safty-Grip® Bath and Shower Mats

Perfect for shower stall or bathtub.

- Suction-backed to stay firmly in place
- Latex-free construction
- Textured surface prevents slippage
- Shower mat is perforated for improved drainage
- Mildew-resistant



FG704104



FG703504

No.	Color	Description	U.S. Dimensions	U.S. Ship Wt/Ctn	Metric Dimensions	Metric Ship Wt/Ctn	Pack
FG703504	WHT, BSTON	Safty-Grip® Bath Mat, Medium	22.5" l x 14" w	4.9 lb	57.2 cm x 35.6 cm	2.2 kg	4
FG704104	WHT, BSTON	Safty-Grip® Bath Mat, Large	28" l x 16" w	8.9 lb	71.1 cm x 40.6 cm	4 kg	4
FG704304	WHT, BSTON	Safty-Grip® Bath Mat, XLarge	36" l x 18" w	12.4 lb	91.4 cm x 45.7 cm	5.6 kg	4
FG711204	WHT	Safty-Grip® Shower Mat	22.25" l x 22.25" w	1.3 lb	56.5 cm x 56.5 cm	0.6 kg	4



SEE PAGE 45



SEE PAGE 60

RUBBERMAID HYGEN™ MICROFIBER CLEANING

Filter Bucket and Wringer 45
 Double-Sided Folding Microfiber Mop Frame 45
 Double-Sided Microfiber Mops 46
 Rubbermaid HYGEN™ Microfiber Buckets 47
 Press Wring Bucket 47
 Rubbermaid PULSE™ Microfiber Floor Cleaning System with Double-Sided Frame 48
 Rubbermaid PULSE™ Microfiber Floor Cleaning System with Single-Sided Frame 49
 Rubbermaid HYGEN™ Quick-Connect Handles and Poles 49
 Rubbermaid HYGEN™ Quick-Connect Single-Sided Frames 50
 Rubbermaid HYGEN™ Single-Sided Mops 51
 Rubbermaid HYGEN™ Flexi-Frame 52
 Rubbermaid HYGEN™ Microfiber Flexible Dusting Wands 52
 Rubbermaid HYGEN™ Microfiber Cloths 55
 Rubbermaid HYGEN™ Microfiber Mitts 55
 Rubbermaid HYGEN™ Sanitizer-Safe Microfiber Cloth 54
 Rubbermaid HYGEN™ Microfiber Kit with Charging Bucket 54
 Rubbermaid HYGEN™ Microfiber Kit with Rubbermaid PULSE™ 54

STANDARD MICROFIBER CLEANING

Microfiber Light Commercial Cloths 55
 Professional Spray Mop 55
 Rubbermaid FLOW™ Microfiber Finishing Systems 56
 Microfiber Flat Mop Finishing 57
 Microfiber Finish System 57

DUSTING TOOLS

Overhead Dusting Tools 58
 Flexible-Head Overhead Dusting Tools 58
 Lambswool Duster 58

WAVEBRAKE® MOPPING SYSTEMS

WaveBrake® 35-Qt High-Performance Mopping Systems 60
 WaveBrake® 35-Qt Mopping Trolleys 61
 WaveBrake® 35-Qt Dual-Water Mopping Combos 61
 WaveBrake® 44-Qt Mopping System 62
 WaveBrake® 26-Qt Mopping System 62
 WaveBrake® Mopping System Accessories 63
 Tandem™ 31-Qt Bucket and Wringer Combo 63

WET MOPS

Wet Mop Selection Guide 64
 Web Foot® Microfiber Tube Mops 66
 Web Foot® Microfiber String Mops 66
 Web Foot® Mops 68
 Web Foot® Shrinkless Wet Mops 67
 Web Foot® Wet Mops 67
 Web Foot® Finish Mops 67

Swinger Loop® Shrinkless Wet Mops 68
 Swinger Loop® Wet Mops 68
 Swinger Loop® Finish Mops 68
 Super Stitch® Blend Mops 69
 Super Stitch® Rayon Mops 69
 Super Stitch® Cotton Mops 69
 Super Stitch® Finish Mops 69
 Universal Headband Blue Blend Mops 70
 Universal Headband Rayon Mops 70
 Universal Headband Cotton Mops 70
 Cut-End Blend Mops 71
 Cut-End Rayon Mops 71
 Cut-End Cotton Mops 71
 Bolt-On Cut-End Blend Mops 72
 Bolt-On Cut-End Rayon Mops 72
 Bolt-On Cut-End Cotton Mops 72
 8-Ply Cut-End Cotton Mops 72
 Synthetic Blend Mops 73
 Clean Room Maintenance Mops 73
 Rough Floor Wet Mops 73
 Economy Cotton and Rayon Cut-End Wet Mops 74
 Nylon Finish Mops 74

WET MOP HANDLES AND ACCESSORIES

Wet Mop Handles 75
 Adjustable Mop Handles 76
 Bolt-On Wet Mop Handle 76
 Laundry Net 76



EXECUTIVE
SERIES™

MOPPING ACCESSORIES

BRUTE® Buckets77
 Pail and Mop Strainer Combination77
 Upright Scrubber Pad Holder77
 Steel Sponge Mop/Double Pails77

DUST MOPS

Dust Mop Selection Guide78
 Microfiber Looped-End Dust Mops.....79
 Twisted-Loop Dust Mops80
 Trapper® Dust Mops.....81
 Kut-A-Way® Dust Mops.....81
 Disposable Cut-End Blended Dust Mops.....81
 Disposable Cut-End Cotton Dust Mops82
 Cut-to-Length Dust Mops83
 Dust Cloth Holder and Stretch Dust Cloths.....83
 Wedge Mop System.....83
 Snap-On Wire Dust Mop Frames.....84
 Snap-On Dust Mop Handles.....84

CARPET BONNETS

Microfiber Carpet Bonnets85
 Carpet Bonnets85

BROOMS AND BRUSHES

Broom and Brush Construction86
 Angle Brooms.....87
 Corn Brooms.....87
 Fine Floor Sweeps.....87
 Medium Floor Sweeps88
 Heavy-Duty Floor Sweeps88

Wide-Angle Brace for Use with
 Brace Brooms88
 Brace Brooms89
 Street Sweeps.....89
 Broom Handles.....89
 Counter Brushes/Whisk Broom/
 Heavy-Duty Dust Pans90
 Plastic-Handle Utility Brushes.....90
 Truck and Wash Brush and Floor/Deck Scrub.91
 Masonry Brushes.....91
 Wire Brushes.....91

SCRUB BRUSHES AND SQUEEGEES

Toilet Bowl Brushes and Holders.....92
 Scrub Brushes92
 Wall Washer Kit.....92
 Floor Squeegees92

DUST PANS

Lobby Pro® Upright Dust Pans94
 Lobby Pro® Wet/Dry Spill Pan.....94

CLEANING CARTS

Executive Series™ Cleaning Carts95
 Cleaning Carts Selection Guide96
 High-Capacity Janitorial Cleaning Carts
 with Bins98
 High-Security Janitorial Cleaning Carts.....98
 High-Capacity Janitorial Cleaning Carts.....99
 Traditional Janitorial Cleaning Carts.....100
 Three-Compartment Carts.....100
 Deluxe Wood-Paneled Carts.....101

Compact Housekeeping Carts101
 Cleaning, Deluxe Paneled, and Compact
 Housekeeping Cart Accessories.....102
 Metal Housekeeping Carts103
 Metal Housekeeping Cart Accessories.....104
 Classic Housekeeping Carts106
 Classic Housekeeping Cart Accessories107

VACUUMS

Commercial Backpack Vacuum Cleaners.....110
 Commercial Backpack Vacuum Cleaner
 Replacement Parts and Accessories.....111
 Manual-Height Upright Vacuum Cleaners ...112
 Dual-Motor Power-Height Upright
 Vacuum Cleaners112
 Traditional Upright Vacuum Cleaners113
 Ultra-Light Upright Vacuum Cleaners113
 Replacement and Maintenance Parts for
 Upright Vacuum Cleaners114
 Commercial Wet and Dry Vacuum Cleaners 115
 DVAC 1 Pass Cleaning Solution™116

MECHANICAL SWEEPERS

Mechanical Sweepers118

TOOLS AND ACCESSORIES

Closet Organizer and Tool Holder120
 Ironing Organizers120
 Two-Step Folding Stepstool120
 Mobile Two-Step Stepstool121
 Spray Bottle and Trigger121
 Deluxe Carry Caddy.....121

Cleaning



LOOK FOR THE NEW SPECIALLY MARKED EXECUTIVE SERIES™ PRODUCTS.



Clean Water System

Introducing a revolutionary floor cleaning system with the award-winning integrated water filter for generating:

- CLEANER WATER
- CLEANER MOPS
- CLEANER FLOORS



Proven Performance
TO ENSURE HEALTHY, SAFE ENVIRONMENTS

Complete System
TO MAXIMIZE PRODUCTIVITY AND VALUE

Training and Support
TO DELIVER OPTIMAL RESULTS

Finally a microfiber floor cleaning system that helps anyone maximize productivity and minimize water and chemical usage, while producing healthier, safer environments.



SCHOOLS



OFFICE BUILDINGS



RESTAURANTS



AIRPORTS

SMARTER CLEANING

The Rubbermaid HYGEN™ Clean Water System features a Filter Bucket and Wringer with built-in scrubbers to help loosen and remove debris from the mop. Twin rollers allow for optimized wringing efficiency, and an innovative filtering system processes dirty water into clean water with a simple tilt of the bucket.

ROLLER WRINGER

Twin roller design provides optimized wringer efficiency.

See it in
ACTION

www.rubbermaidhygen.com

ADJUSTABLE MOISTURE LEVEL

Allows users to select desired mop dampness.

FLOOR DRAIN

Empties bucket without lifting.



COMPLETE SYSTEM

Fits all Rubbermaid Commercial Products cleaning carts.



RINSING AND SCRUBBING

Insert the mop into the bucket. Move the mop up and down to enable the built-in scrubbers to remove soil from the mop.

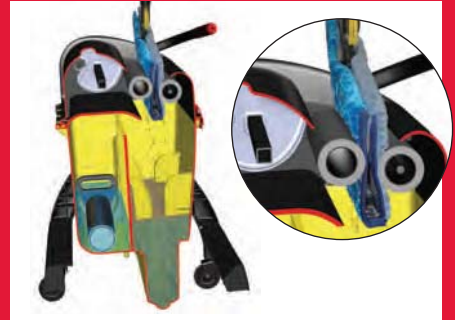

WRINGING

Lift the mop to position it between the two rollers located at the top of the bucket. Press the handle down to wring the mop. Turn the adjustment dial to select your desired moisture level.



TRANSFERRING

Tilt the bucket 90 degrees by pressing the handle. This allows the dirty water to transfer to the chamber that has the integrated filter.



FILTERING

Once the water is completely transferred to the filter chamber, rotate the bucket back to its original position. Clean, filtered water will flow back into the mopping chamber, ready for mopping.

Filter Bucket and Wringer

Award-winning integrated filter to generate clean water!

- Integrated filter improves productivity and reduces chemical/water waste
- Back-flushable filter is easy to use and maintain
- Built-in agitators remove more dirt from mops
- Twin roller design optimizes wringer efficiency
- Adjustable roller wringer accommodates different mop thicknesses and desired moisture levels
- Floor drain for easy and fast emptying
- Integrated bail for easy lifting and emptying

New!

See it in ACTION
www.rubbermaidhygen.com



1791800
FILTER REPLACEMENT



1791797

No.	Color	Description	U.S. Dimensions	U.S. Capacity	U.S. Ship Wt/Ctn	Metric Dimensions	Metric Capacity	Metric Ship Wt/Ctn	Pack
1791797	YELLOW	Filter Bucket with Wringer Combo Yellow	36" l x 24" w x 21" h	16 qt	34.3 lb	91.4 cm x 60.9 cm x 53.3 cm	15.1 L	15.6 kg	1
1791798	BLACK	Filter Bucket Wringer	24.25" l x 14" w x 8" h	N/A	5.0 lb	61.6 cm x 35.6 cm x 20.3 cm	N/A	2.3 kg	1
1791799	YELLOW	Filter Bucket	21" l x 14.4" w x 19.8" h	16 qt	9.0 lb	53.3 cm x 36.5 cm x 50.2 cm	15.1 L	4.1 kg	1
1791800	BLACK	Filter Replacement	17.3" l x 5.8" w x 4.5" h	N/A	4.5 lb	43.9 cm x 14.7 cm x 11.4 cm	N/A	2.0 kg	1
1791801	RED/YELLOW/ BLUE/GREEN	Color-Coded Wringer Handle Grip Kit	4.5" l x 3.4" w x 3.4" h	N/A	1.0 lb	11.4 cm x 8.6 cm x 8.6 cm	N/A	0.5 kg	1
1821662	N/A	Locking Casters	5.5" l x 4.5" w x 1.81" h	N/A	32.9 lb	14.0 cm x 11.4 cm x 4.6 cm	N/A	14.9 kg	1
1799152*	N/A	Lock'N Go Kit	6" l x 2" w x .2" h	N/A	0.05 lb	15.2 cm x 5.1 cm x .5 cm	N/A	0.02 kg	1

* Only required for FG9T7200, FG9T7300, and FT9T7500 Cleaning Carts.

Double-Sided Folding Mop Frame

New!

Designed especially for Clean Water System microfiber mops.

- Easy to attach and detach mop
- Stainless steel components for enhanced durability
- For use with Rubbermaid® Double-Sided Microfiber Mops



1855312

ES 1863894



Quick-Connect mechanism compatible with most Rubbermaid HYGEN™ handles.*

EASY HANDS-FREE MOP ATTACHMENT



1. Place frame on open mop and slide it into pockets.



2. Lift . . .



. . . and fold the frame closed for double-sided mopping.

No.	Color	Description	U.S. Dimensions	U.S. Ship Wt/Ctn	Metric Dimensions	Metric Ship Wt/Ctn	Pack
1855312*	BLACK	Double-Sided Folding Frame	16.25" l x 8.5" w x 0.938" h	6.25 lb	41.3 cm x 21.6 cm x 2.4 cm	2.8 kg	3
1863894*	BLACK	Executive Series™ Double-Sided Folding Frame	16.25" l x 8.5" w x 0.938" h	6.25 lb	41.3 cm x 21.6 cm x 2.4 cm	2.8 kg	3

New!

*For use with FGQ75500 Rubbermaid HYGEN™ Extension Handle. FGQ75000 Straight Handle and FGQ76000 Ergo Handle are not recommended.

WHEN ORDERING PRODUCTS WITH BOLD COLOR CODES, PLEASE SPECIFY COLOR CODE AFTER THE PRODUCT NUMBER. SEE THE PRODUCT COLOR GUIDE AT THE BACK OF THE CATALOG.



Double-Sided **New!** Microfiber Mops

Specifically designed for the Rubbermaid HYGEN™ Clean Water System. Combines the best features of microfiber mops and string mops.

- Superior durability offers best cost-in-use
- Double-sided design provides twice the coverage and features different textiles on each side for different cleaning tasks



DURABLE UP TO
1000
laundrings

PROVEN TO REMOVE
99.9%
of microorganisms¹

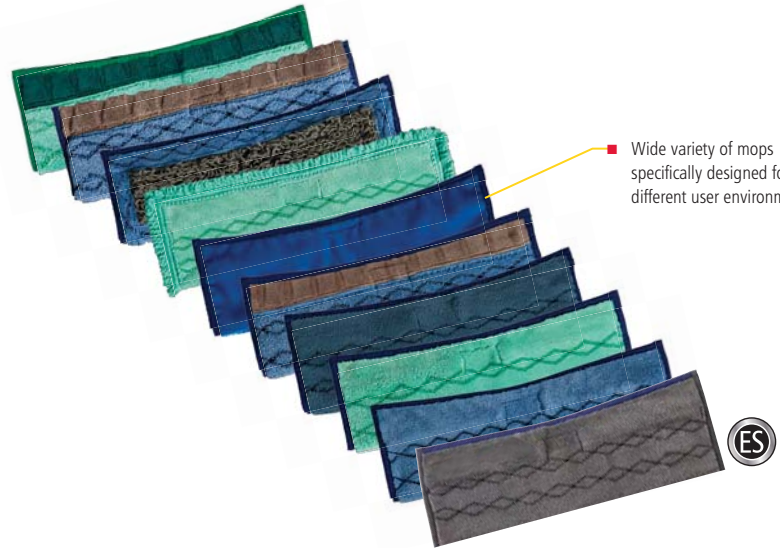

Wide variety of mops specifically designed for different user environments.



1791792

MICROFIBER DUST MOP WITH FRINGE

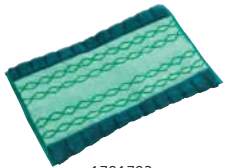

1791793

MICROFIBER DUST MOP



COLOR-CODED RIBBONS

Classify mop usage to help prevent cross-contamination.

	Microbe Removal	Absorbency	Grease/Oil Removal	General Soil Removal	Durability	Floor Type	Recom'd User Environment
General-Purpose Microfiber Mop 1791678 Executive 1863886 						Smooth surfaces such as VCT, Linoleum and Marble	Office Buildings, Schools, Retail Stores, Airports, and Stadiums
Rough-Surface Microfiber Mop 1791794						Textured surfaces such as Ceramic Tile, Natural Stone, and Terrazzo	Restaurants, Schools
Rough-Surface Scrub Microfiber Mop 1791796						Textured surfaces such as Ceramic Tile, Natural Stone, and Terrazzo	Restaurants, Schools
Microfiber Mop Plus 1791680	 99.9%					Smooth surfaces such as VCT, Linoleum, and Marble	Healthcare
Microfiber Wet and Dust Mop Plus for PULSE™ 1791679* Executive 1863887 	 99.9%					Smooth surfaces such as VCT, Linoleum, and Marble	Healthcare
Microfiber Wet and Scrub Mop Plus 1791791	 99.9%					Smooth surfaces such as VCT, Linoleum, Marble, and Ceramic Tile	Healthcare
Microfiber High-Absorbency Mop Plus 1791795	 99.9%					Smooth surfaces such as VCT, Linoleum, and Marble	Healthcare, Schools

No.	Color	Description	U.S. Dimensions	U.S. Ship Wt/Ctn	Metric Dimensions	Metric Ship Wt/Ctn	Pack	
New!	1791678	GRAY	General-Purpose Microfiber Mop	17.5" l x 12" w x 0.5" h	3.1 lb	44.5 cm x 30.5 cm x 1.3 cm	1.4 kg	6
	1863886	GRAY	Executive Series™ Multipurpose Microfiber Flat Mop	17.5" l x 12" w x 0.5" h	3.1 lb	44.5 cm x 30.5 cm x 1.3 cm	1.4 kg	6
	1791794	BLUE	Rough-Surface Microfiber Mop	17.5" l x 12" w x 0.5" h	4.3 lb	44.5 cm x 30.5 cm x 1.3 cm	1.9 kg	6
	1791796	BLUE	Rough-Surface Scrub Microfiber Mop	17.5" l x 12" w x 1" h	3.5 lb	44.5 cm x 30.5 cm x 2.5 cm	1.6 kg	6
	1791680	BLUE	Microfiber Mop Plus	17.5" l x 12" w x 0.5" h	2.6 lb	44.5 cm x 30.5 cm x 1.3 cm	1.2 kg	6
	1791791	BLUE	Microfiber Wet and Scrub Mop Plus	17.5" l x 12" w x 0.5" h	2.7 lb	44.5 cm x 30.5 cm x 1.3 cm	1.2 kg	6
	1791679*	GREEN/BLUE	Microfiber Wet and Dust Mop Plus for PULSE™	17.5" l x 12" w x 0.5" h	2.7 lb	44.5 cm x 30.5 cm x 1.3 cm	1.2 kg	6
New!	1863887	GRAY	Executive Series™ Multipurpose PULSE™ Wet and Dust Mop	17.5" l x 12" w x 0.5" h	2.7 lb	44.5 cm x 30.5 cm x 1.3 cm	1.2 kg	6
	1791795	BLUE	Microfiber High-Absorbency Mop Plus	17.5" l x 12" w x 1" h	3.8 lb	44.5 cm x 30.5 cm x 2.5 cm	1.7 kg	6
	1791792	GREEN	Microfiber Dust Mop with Fringe	19.5" l x 14" w x 0.5" h	3.1 lb	49.5 cm x 35.6 cm x 1.3 cm	1.4 kg	6
	1791793	GREEN	Microfiber Dust Mop	17.5" l x 12" w x 0.5" h	2.7 lb	44.5 cm x 30.5 cm x 1.3 cm	1.2 kg	6

*To be used with Rubbermaid PULSE™ with Double-Sided Frame. Refer to Rubbermaid PULSE™ section.

¹ Always use cleaning chemicals or disinfectants as directed by your facility manager.

WHEN ORDERING PRODUCTS WITH BOLD COLOR CODES, PLEASE SPECIFY COLOR CODE AFTER THE PRODUCT NUMBER. REFER TO THE PRODUCT COLOR GUIDE AT THE BACK OF THE CATALOG.



Check out the items marked with this symbol for our new line of Executive Series™ products.

Rubbermaid HYGEN™ Microfiber Buckets

Rubbermaid HYGEN™ Microfiber Buckets complete a highly efficient flat mop cleaning system for healthcare and sanitary maintenance applications.

- Use with Rubbermaid HYGEN™ Microfiber Damp Mops and Quick-Connect tools for a continuous cleaning process with "no touch" wringing
- Easy-to-clean, lightweight nonporous plastic construction
- Buckets work with all Rubbermaid HYGEN™ Microfiber Cleaning Carts

FGQ95088 Charging Bucket

- Reduces cross-transmission when a fresh mop is used for each room or area
- All-plastic bucket holds 10–20 microfiber damp mops
- Each mop holds enough liquid to clean up to 250 sq ft; fully loaded bucket (20 mops) can clean up to 5,000 sq ft
- Safe for use in MRI rooms

1791802 Top-Down Charging Bucket

- Sieve design enables users to effectively and ergonomically moisten mops
- Holds up to 16 Clean Water System double-sided microfiber mops
- Reduces cross-transmission when a fresh mop is used for each room or area
- Safe for use in MRI rooms
- Best for use with Clean Water System microfiber mops

New!

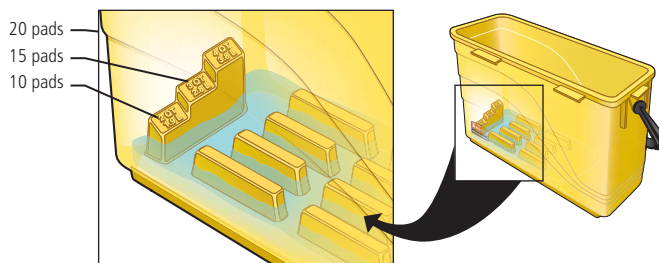

FGQ95088 Bucket design prevents oversaturation of microfiber mops and features a measuring guide for filling with cleaning and disinfecting solution before mops are added.

USING THE 1791802 CHARGING BUCKET



1. Fold the mop in half with the face material outside. Place folded mop vertically inside the bucket.
2. Pour disinfectant over the hinged sieve to moisten the mops evenly.



No.	Color	Description	U.S. Dimensions	U.S. Ship Wt/Ctn	Metric Dimensions	Metric Ship Wt/Ctn	Pack
FGQ95088	YEL	Charging Bucket	23.88" l x 9.5" w x 13.63" h	16.0 lb	60.7 cm x 24.1 cm x 34.6 cm	7.3 kg	3
1863892	GRAY	Executive Series™ Charging Bucket	23.88" l x 9.5" w x 13.63" h	16.0 lb	60.7 cm x 24.1 cm x 34.6 cm	7.3 kg	3
1791802	YELLOW	Top-Down Charging Bucket	23.88" l x 9.5" w x 13.63" h	17.5 lb	60.7 cm x 24.1 cm x 34.6 cm	7.9 kg	3

Press Wring Bucket

- Use when flood cleaning or heavier liquid lay-down is desired
- Press sieve provides easy, "no touch" wringing
- For use with single-sided microfiber flat mops up to 18" in length
- Nonmarking casters
- Floor drain for fast emptying
- Available in Blue with lid (item FGQ93000) for floor finish application



Unique, ribbed "washboard" surface removes dirt and debris from mops before wringing.



FGQ90088

No.	Color	Description	U.S. Dimensions	U.S. Ship Wt/Ctn	Metric Dimensions	Metric Ship Wt/Ctn	Pack
FGQ90088	YEL	Press Wring Bucket	14.5" l x 26.2" w x 16.1" h	10.2 lb	36.8 cm x 66.5 cm x 40.9 cm	4.6 kg	1

Rubbermaid PULSE™ Microfiber Floor Cleaning System with Double-Sided Frame

The most productive floor cleaning system with best-in-class onboard reservoir and innovative double-sided frame. Cleans twice the area with one mop. Dusting and wet mopping with one convenient tool. Now shipping with 2 free microfiber mops!

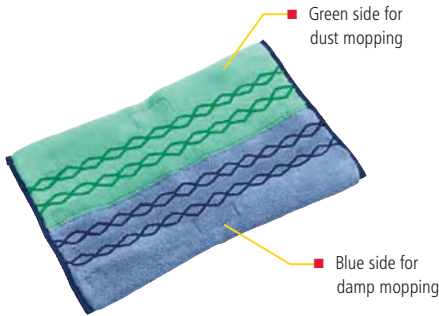

Green side for dust mopping

Blue side for damp mopping

2 JOBS, 1 TOOL

Simply dust mop, flip, and damp mop—accomplish two tasks with only one tool! (Two mops included.)



1855312

DOUBLE-SIDED FRAME
Provides twice the coverage.

1835529 RUBBERMAID PULSE™ FLOOR CLEANING KIT WITH DOUBLE-SIDED FRAME

INCLUDES:
Trigger Handle with Fluid Reservoir, one Clean Water System Double-Sided Folding Frame, and two microfiber dust and wet mops.

ONBOARD FLUID RESERVOIR

High-capacity refillable reservoir holds enough solution to clean up to 850 sq ft of floor space. Reservoir windows allow easy monitoring of fluid level.

New!

TRIGGER HANDLE

Red ergonomic trigger handle dispenses three streams of cleaning solution with each press.

LIGHTWEIGHT CONSTRUCTION

Weighs only 4 lbs when fully loaded with solution.

1835529 with 1791679 Microfiber Dust and Wet Mop Plus for PULSE™



1863885 with 1863887 Executive Series™ Multipurpose PULSE™ Wet and Dust Mop



FGQ96600

RUBBERMAID PULSE™ CADDY

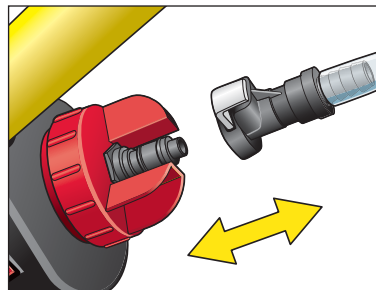

CLEAN CONNECT™ CAP

Clean Connect™ Cap and Rubbermaid PULSE™ hose snap together for spill-free refilling. Flow automatically stops when reservoir is full.



OPTIONAL RUBBERMAID PULSE™ CADDY

High-capacity Rubbermaid PULSE™ Caddy allows users to clean up to 10,000 sq ft—reducing the frequency of trips to the supply closet. The Rubbermaid PULSE™ Caddy is designed to be securely transported in Rubbermaid® Cleaning Carts for efficient on-the-go refills.

WHEN ORDERING PRODUCTS WITH **BOLD** COLOR CODES, PLEASE SPECIFY COLOR CODE AFTER THE PRODUCT NUMBER. REFER TO THE PRODUCT COLOR GUIDE AT THE BACK OF THE CATALOG.



Check out the items marked with this symbol for our new line of Executive Series™ products.

Rubbermaid PULSE™ Microfiber Floor Cleaning System with Single-Sided Frame

Clean more square feet in less time with Rubbermaid PULSE™. Industry-best microfiber, onboard reservoir, and user-controlled release of solution mean cleaner floors faster, easier, and more effectively. *Now shipping with 2 free microfiber mops!*

RUBBERMAID HYGEN™ QUICK-CONNECT HANDLES AND POLES

- Lightweight aluminum construction is safe for MRI rooms
- Handles available in straight or ergonomic bend styles, in adjustable lengths between 20" and 72"
- Extension poles make quick work of high-reach cleaning tasks, with lengths up to 18'
- FGQ70100 Quick-Connect Adapter allows use of Quick-Connect handles and poles with any standard threaded tool

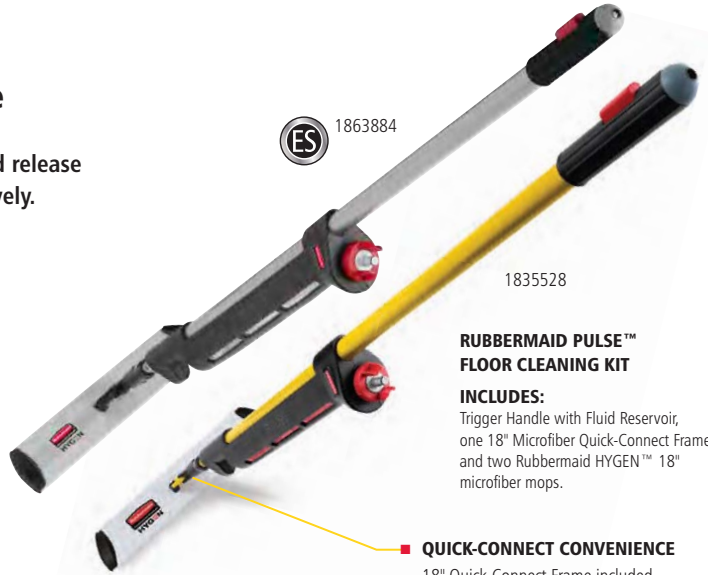

RUBBERMAID PULSE™ FLOOR CLEANING KIT
INCLUDES:
 Trigger Handle with Fluid Reservoir, one 18" Microfiber Quick-Connect Frame, and two Rubbermaid HYGEN™ 18" microfiber mops.

■ **QUICK-CONNECT CONVENIENCE**
 18" Quick-Connect Frame included. Also works with Rubbermaid HYGEN™ 11" and 24" Quick-Connect Frames and Mops.



RUBBERMAID PULSE™

No.	Color	Description	U.S. Dimensions	U.S. Capacity	U.S. Ship Wt/Ctn	Metric Dimensions	Metric Capacity	Metric Ship Wt/Ctn	Pack
1835529	YELLOW	Rubbermaid PULSE™ Mopping Kit with Double-Sided Folding Frame	52" l x 4.25" w x 3.5" h	19 oz	4.5 lb	132.1 cm x 10.8 cm x 8.9 cm	.56 L	2.0 kg	1
New! 1863885	SILVER	Rubbermaid PULSE™ Executive Series™ Mopping Kit with Double-Sided Folding Frame	52" l x 4.25" w x 3.5" h	19 oz	4.5 lb	132.1 cm x 10.8 cm x 8.9 cm	.56 L	2.0 kg	1
1835528	YELLOW	Rubbermaid PULSE™ Mopping Kit with Single-Sided Frame	56" l x 4.88" w x 3.75" h	19 oz	5.7 lb	142.2 cm x 12.4 cm x 9.5 cm	.56 L	2.6 kg	1
New! 1863884	SILVER	Rubbermaid PULSE™ Executive Series™ Mopping Kit with Single-Sided Frame	56" l x 4.88" w x 3.75" h	19 oz	5.7 lb	142.2 cm x 12.4 cm x 9.5 cm	.56 L	2.6 kg	1
FGQ96600	0000	Rubbermaid PULSE™ Caddy	14.13" l x 8.75" w x 10.75" h	2 gal	3.6 lb	35.9 cm x 22.2 cm x 27.3 cm	7.5 L	1.6 kg	1

QUICK-CONNECT HANDLES

No.	Color	Description	U.S. Dimensions	U.S. Ship Wt/Ctn	Metric Dimensions	Metric Ship Wt/Ctn	Pack
FGQ74500	YLOO	20"–40" (50.8 cm–101.6 cm) Quick-Connect Short Extension Handle	Open: 40" l x 2" w x 2" h Closed: 20" l x 2" w x 2" h	6.5 lb	Open: 101.6 cm x 5.1 cm x 5.1 cm Closed: 50.8 cm x 5.1 cm x 5.1 cm	2.9 kg	6
New! 1863883	SILVER	20"–40" (50.8 cm–101.6 cm) Executive Series™ HYGEN™ Series Microfiber Telescoping Handle	Open: 40" l x 2" w x 2" h Closed: 20" l x 2" w x 2" h	6.5 lb	Open: 101.6 cm x 5.1 cm x 5.1 cm Closed: 50.8 cm x 5.1 cm x 5.1 cm	2.9 kg	6
FGQ75000	YLOO	58" (147.3 cm) Quick-Connect Handle	58" l x 1.6" w x 1.6" h	6.3 lb	147.3 cm x 4.1 cm x 4.1 cm	2.9 kg	6
FGQ75500	YLOO	48"–72" (121.9 cm–182.9 cm) Quick-Connect Straight Extension Handle	Open: 72" l x 2" w x 2" h Closed: 41" l x 2" w x 2" h	8.8 lb	Open: 182.9 cm x 5.1 cm x 5.1 cm Closed: 104.1 cm x 5.1 cm x 5.1 cm	4 kg	6
New! 1863882	SILVER	48"–72" (121.9 cm–182.9 cm) Executive Series™ HYGEN™ Series Microfiber Telescoping Handle	Open: 72" l x 2" w x 2" h Closed: 41" l x 2" w x 2" h	8.8 lb	Open: 182.9 cm x 5.1 cm x 5.1 cm Closed: 104.1 cm x 5.1 cm x 5.1 cm	4 kg	6
FGQ76000	0000	48"–72" (121.9 cm–182.9 cm) Quick-Connect Ergo Adjustable Handle	Open: 72" l x 7.5" w x 2.5" h Closed: 48" l x 7.5" w x 2.5" h	8.7 lb	Open: 182.9 cm x 19.1 cm x 6.4 cm Closed: 121.9 cm x 19.1 cm x 6.4 cm	3.9 kg	6

QUICK-CONNECT EXTENSION POLES

No.	Color	Description	U.S. Dimensions	U.S. Ship Wt/Ctn	Metric Dimensions	Metric Ship Wt/Ctn	Pack
FGQ76500	YLOO	4'–8' Quick-Connect Extension Pole	Open: 96" l x 2.1" w x 2.1" h Closed: 48" l x 2.1" w x 2.1" h	16.7 lb	Open: 243.8 cm x 5.3 cm x 5.3 cm Closed: 121.9 cm x 5.3 cm x 5.3 cm	7.6 kg	6
FGQ77000	YLOO	6'–12' Quick-Connect Extension Pole	Open: 144" l x 2.1" w x 2.1" h Closed: 72" l x 2.1" w x 2.1" h	21.7 lb	Open: 365.8 cm x 5.3 cm x 5.3 cm Closed: 182.9 cm x 5.3 cm x 5.3 cm	9.8 kg	6
FGQ77500	YLOO	6'–18' Quick-Connect Extension Pole	Open: 216" l x 2.1" w x 2.1" h Closed: 72" l x 2.1" w x 2.1" h	16.6 lb	Open: 548.6 cm x 5.3 cm x 5.3 cm Closed: 182.9 cm x 5.3 cm x 5.3 cm	7.5 kg	3
FGQ70100	BK00	ACME to Quick-Connect Adapter	4.5" l x 1.1" w x 1.1" h	0.3 lb	11.4 cm x 2.8 cm x 2.8 cm	0.14 kg	3

Rubbermaid HYGEN™ Quick-Connect Single-Sided Frames

New!

Quick-Connect Frames feature a flat profile that slides easily under furniture and equipment. Trapezoidal shape improves cleaning in corners and other hard-to-reach areas.

- Lightweight aluminum construction is safe for MRI rooms
- Replaceable hook and loop strips attach all Rubbermaid HYGEN™ Microfiber Damp and Dust Mops
- Rounded plastic end caps help protect walls and furniture

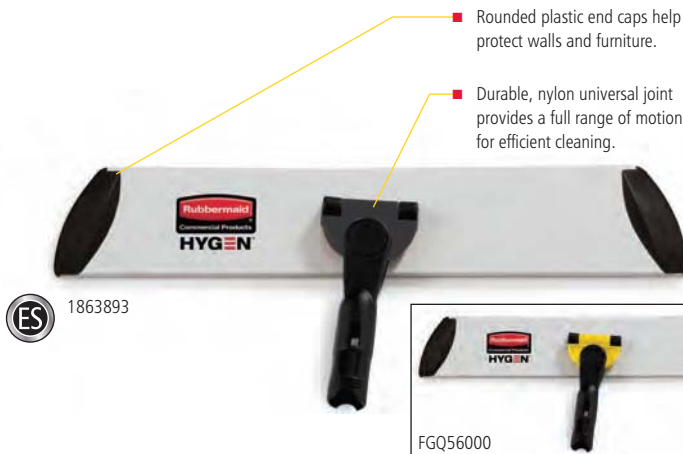

FGQ57000 24" QUICK-CONNECT FRAME WITH SQUEEGEE

Features a unique pull-type squeegee for water and debris collection.



One-step Quick-Connect mechanism makes mop assembly and frame changes fast and easy.



WIDTHS FOR ANY APPLICATION

Available in 11" to 60" widths.



QUICK-CONNECT SINGLE-SIDED FRAMES

No.	Color	Description	U.S. Dimensions	U.S. Ship Wt/Ctn	Metric Dimensions	Metric Ship Wt/Ctn	Pack
FGQ55000	YL00	11" (27.9 cm) Quick-Connect Wall/Stair Frame	11.1" l x 3.5" w x 1.5" h	4.9 lb	28.2 cm x 8.9 cm x 3.8 cm	2.2 kg	6
FGQ56000	YL00	18" (45.7 cm) Quick-Connect Wet/Dry Frame	18.1" l x 3.5" w x 1.5" h	6.5 lb	46 cm x 8.9 cm x 3.8 cm	2.9 kg	6
1863893	BLACK	18" (45.7 cm) Executive Series™ Quick-Connect Wet/Dry Frame	18.1" l x 3.5" w x 1.5" h	6.5 lb	46 cm x 8.9 cm x 3.8 cm	2.9 kg	6
FGQ57000	YL00	24" (61 cm) Quick-Connect Squeegee Frame	24.1" l x 4.5" w x 1.5" h	9.2 lb	61.2 cm x 11.4 cm x 3.8 cm	4.2 kg	6
FGQ58000	YL00	36" (91.4 cm) Quick-Connect Hall Dusting Frame	36.1" l x 3.5" w x 1.5" h	13.1 lb	91.7 cm x 8.9 cm x 3.8 cm	5.9 kg	6
FGQ59000	YL00	48" (121.9 cm) Quick-Connect Hall Dusting Frame	48.1" l x 3.5" w x 1.5" h	16.7 lb	122.2 cm x 8.9 cm x 3.8 cm	7.6 kg	6
FGQ59500	YL00	60" (152.4 cm) Quick-Connect Hall Dusting Frame	60" l x 5" w x 3" h	20.8 lb	152.4 cm x 12.7 cm x 7.6 cm	9.4 kg	6

QUICK-CONNECT FRAME ACCESSORIES

No.	Color	Description	U.S. Dimensions	U.S. Ship Wt/Ctn	Metric Dimensions	Metric Ship Wt/Ctn	Pack
FGQ11000	BK00	11" (27.9 cm) Hook-and-Loop Replacement Set for FGQ55000	10" l x 1.1" w x 0.25" h	0.86 lb	25.4 cm x 2.8 cm x 0.6 cm	0.39 kg	6
FGQ18000	BK00	18" (45.7 cm) Hook-and-Loop Replacement Set for FGQ56000	17.1" l x 1.1" w x 0.25" h	1.0 lb	43.4 cm x 2.8 cm x 0.6 cm	0.04 kg	6
FGQ24000	BK00	24" (61 cm) Hook-and-Loop Replacement Set for FGQ57000	23" l x 1.1" w x 0.25" h	1.28 lb	58.4 cm x 2.8 cm x 0.6 cm	0.58 kg	6
FGQ36000	BK00	36" (91.4 cm) Hook-and-Loop Replacement Set for FGQ58000	35" l x 1.1" w x 0.25" h	1.64 lb	88.9 cm x 2.8 cm x 0.6 cm	0.74 kg	6
FGQ48000	BK00	48" (121.9 cm) Hook-and-Loop Replacement Set for FGQ59000	47" l x 1.1" w x 0.25" h	2.06 lb	119.4 cm x 2.8 cm x 0.6 cm	0.93 kg	6
FGQ60000	BK00	60" (152.4 cm) Hook-and-Loop Replacement Set for FGQ59500	60" l x 1.13" w x 0.25" h	2.48 lb	152.4 cm x 2.9 cm x 0.6 cm	1.1 kg	6
FGQ57100	GY00	24" (61 cm) Squeegee Blade Replacement for FGQ57000	23.2" l x 1.5" w x 0.25" h	1.8 lb	58.9 cm x 3.8 cm x 0.6 cm	0.81 kg	6

WHEN ORDERING PRODUCTS WITH **BOLD** COLOR CODES, PLEASE SPECIFY COLOR CODE AFTER THE PRODUCT NUMBER. REFER TO THE PRODUCT COLOR GUIDE AT THE BACK OF THE CATALOG.



Check out the items marked with this symbol for our new line of Executive Series™ products.

Rubbermaid HYGEN™ Single-Sided Mops

MICROFIBER DAMP MOPS

Superior microfiber textiles proven to remove 99.9% of microorganisms.¹

- Scrubbing strips for cleaning tough, dried-on stains
- Reduces water and chemical consumption up to 90% and 95% respectively
- Helps reduce cross-transmission (when using color-coded products by area or task)

MICROFIBER DUST MOPS

Best-in-the-industry performance with scrubbing strips and higher pile looped-end construction to capture and hold more dust and debris.

- Premium looped-end construction reduces linting and improves dust pickup
- Withstands up to 200°F hot water laundering for bleach-free sanitizing

BLEACH-SAFE DURABILITY

All Rubbermaid Commercial Products microfiber textiles are bleach-safe and proven to last longer and provide better cleaning efficiency than non-bleach-safe textiles.

- Rubbermaid bleach-safe microfiber withstands even the harshest high-PH detergents
- Bleach sanitizes textiles when laundering below 160°F (CDC minimum temperature when not using bleach)
- Bleach (hypochlorite-based) solution is the only CDC-recognized disinfectant for use in areas where Clostridium difficile or Creutzfeldt-Jakob Disease may be present

¹Always use cleaning chemicals or disinfectants as directed by your facility manager.

PROVEN TO REMOVE
99.9%
OF MICROORGANISMS¹



FGQ46000

50% MORE SURFACE AREA

Rubbermaid HYGEN™ fringed dust mops provide significantly greater surface area versus nonfringed mops for faster cleaning. Available in widths up to 60".

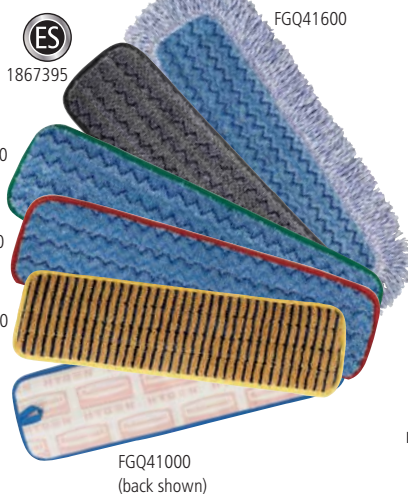

FGQ41000

FGQ41000

FGQ81000

FGQ41000 (back shown)

REMOVES UP TO
80%
MORE DUST AND DIRT THAN
TRADITIONAL COTTON DUST MOPS



FGQ41800 (back)

FGQ41800

1867397

FGQ41200

DURABLE UP TO
500
LAUNDERINGS*
(up to 200 with bleach)

MICROFIBER SINGLE-SIDED DAMP MOPS

No.	Color	Description	U.S. Dimensions	U.S. Ship Wt/Ctn	Metric Dimensions	Metric Ship Wt/Ctn	Pack
FGQ82000	BLOO	11" (27.9 cm) Microfiber Wall/Stair Damp Mop	13.7" l x 5.5" w x 0.5" h	1.5 lb	34.8 cm x 14 cm x 1.3 cm	0.7 kg	6
FGQ81000	YLOO	18" (45.7 cm) Microfiber Super Scrubber Mop	20" l x 5.5" w x 0.5" h	2.0 lb	50.8 cm x 14 cm x 1.3 cm	0.9 kg	6
FGQ41000	GR00, RD00, BLOO	18" (45.7 cm) Microfiber Damp Room Mop	18.5" l x 5.5" w x 0.5" h	2.9 lb	47 cm x 14 cm x 1.3 cm	1.3 kg	12
1863895	GRAY	18" (45.7 cm) Executive Series™ Microfiber Damp Room Mop	18.5" l x 5.5" w x 0.5" h	2.9 lb	47 cm x 14 cm x 1.3 cm	1.3 kg	12
FGQ41500	BLOO	18" (45.7 cm) Microfiber Damp Mop with Scrubber	20.7" l x 5.7" w x 0.5" h	2.8 lb	52.6 cm x 14.5 cm x 1.3 cm	1.3 kg	6
FGQ41600	BLOO	18" (45.7 cm) Microfiber High-Absorbency Mop	20.7" l x 5.7" w x 0.5" h	4.0 lb	52.6 cm x 14.5 cm x 1.3 cm	1.8 kg	6
FGQ41100	BLOO	24" (61 cm) Microfiber Damp Room Mop	24.5" l x 5.5" w x 0.5" h	4.1 lb	62.2 cm x 14 cm x 1.3 cm	1.9 kg	12
FGQ42500	BLOO	24" (61 cm) Microfiber Damp Mop with Scrubber	26.8" l x 5.7" w x 0.5" h	3.1 lb	68.1 cm x 14.5 cm x 1.3 cm	1.4 kg	6

New!

MICROFIBER SINGLE-SIDED DUST MOPS

No.	Color	Description	U.S. Dimensions	U.S. Ship Wt/Ctn	Metric Dimensions	Metric Ship Wt/Ctn	Pack
FGQ41200	GR00, WH00	18" (45.7 cm) Microfiber Room Dust Mop	18.5" l x 5.5" w x 0.5" h	1.4 lb	47 cm x 14 cm x 1.3 cm	0.6 kg	12
FGQ42400	GR00	24" (61 cm) Microfiber Hall Dust Mop	24.5" l x 5.5" w x 0.5" h	2.5 lb	62.2 cm x 14 cm x 1.3 cm	1.1 kg	12
FGQ43600	GR00	36" (91.4 cm) Microfiber Hall Dust Mop	36.5" l x 5.5" w x 0.5" h	3.3 lb	92.7 cm x 14 cm x 1.3 cm	1.5 kg	12
FGQ44800	GR00	48" (121.9 cm) Microfiber Hall Dust Mop	48.5" l x 5.5" w x 0.5" h	5.5 lb	123.2 cm x 14 cm x 1.3 cm	2.5 kg	12

MICROFIBER SINGLE-SIDED FRINGED DUST MOPS

No.	Color	Description	U.S. Dimensions	U.S. Ship Wt/Ctn	Metric Dimensions	Metric Ship Wt/Ctn	Pack
FGQ41800	GR00	18" (45.7 cm) Microfiber Fringed Dust Mop	20.7" l x 5.7" w x 0.5" h	3.2 lb	52.6 cm x 14.5 cm x 1.3 cm	1.5 kg	6
1867397	BLACK	18" (45.7 cm) Executive Series™ Microfiber Fringed Dust Mop	20.7" l x 5.7" w x 0.5" h	3.2 lb	52.6 cm x 14.5 cm x 1.3 cm	1.5 kg	6
FGQ42600	GR00	24" (61 cm) Microfiber Fringed Dust Mop	28" l x 9" w x 0.5" h	3.5 lb	71.1 cm x 22.9 cm x 1.3 cm	1.6 kg	6
FGQ43800	GR00	36" (91.4 cm) Microfiber Fringed Dust Mop	40" l x 9" w x 0.5" h	5.0 lb	101.6 cm x 22.9 cm x 1.3 cm	2.3 kg	6
FGQ44900	GR00	48" (121.9 cm) Microfiber Fringed Dust Mop	52" l x 9" w x 0.5" h	6.8 lb	132.1 cm x 22.9 cm x 1.3 cm	3.1 kg	6
FGQ46000	GR00	60" (152.4 cm) Microfiber Fringed Dust Mop	64" l x 9" w x 0.5" h	8.5 lb	162.6 cm x 22.9 cm x 1.3 cm	3.9 kg	6

*Based on internal testing.

Rubbermaid HYGEN™ Flexi-Frame

Clean faster and more effectively with the Rubbermaid HYGEN™ Flexi-Frame. Frame conforms to curved surfaces for better pickup of dirt and debris.

- Frame flexes to clean both contoured and flat surfaces
- 5 specialized mops for every cleaning need
- Arc shape pulls dirt, hair, and debris toward the center for better pickup
- Proprietary flexible compound will not crack or split, even when used with bleach or peroxide



Rubbermaid HYGEN™ Microfiber Flexible Dusting Wands

Remove dust and allergens from crevices and hard-to-reach areas.

- Wand can be bent to conform to irregular surfaces for improved cleaning
- Quick-Connect handle converts wand to extended-reach cleaning tool
- FGQ85200 High-Performance Flexible Wand cleans heavily soiled areas and picks up hair and larger debris



BETTER SURFACE CONTACT

Flexible mop frame conforms to the shape of the surface being cleaned. Excellent for cleaning hard-to-reach areas. Use hand-held or with Rubbermaid HYGEN™ Quick-Connect handles and extension poles.



SAVE TIME AND MONEY

Hard to reach is not hard to clean. No more hands-and-knees cleaning in tight areas saves time and money.



MICROFIBER FLEXI-FRAME

No.	Color	Description	U.S. Dimensions	U.S. Ship Wt/Ctn	Metric Dimensions	Metric Ship Wt/Ctn	Pack
FGQ85500	BK00	11" Microfiber Flexi-Frame	13.1" l x 5.4" w x 0.8" h	4.9 lb	33.3 cm x 13.7 cm x 2 cm	2.2 kg	6
1867396	BLACK	11" Executive Series™ Microfiber Flexi-Frame Flat Mop	13.1" l x 5.4" w x 0.8" h	4.9 lb	33.3 cm x 13.7 cm x 2 cm	2.2 kg	6
FGQ85600	GR00	Microfiber Flexi-Frame Duster Cover	8.9" l x 5.9" w x 0.3" h	1.4 lb	22.6 cm x 15 cm x 0.8 cm	0.6 kg	12
FGQ86100	WH00	Executive Series™ Microfiber Flexi-Frame Hi-Pile Cover	8.9" l x 5.9" w x 0.9" h	2.2 lb	22.6 cm x 15 cm x 2.3 cm	1.0 kg	12
FGQ87100	BL00	Microfiber Flexi-Frame Glass Cover	8.9" l x 5.9" w x 0.9" h	1.1 lb	22.6 cm x 15 cm x 2.3 cm	0.5 kg	12
FGQ88100	YL00	Microfiber Flexi-Frame Tub and Tile Cover	8.3" l x 8.3" w x 0.3" h	1.6 lb	21.1 cm x 21.1 cm x 0.8 cm	0.7 kg	12
FGQ89100	BL00	Microfiber Flexi-Frame Damp Mop Cover	8.3" l x 8.3" w x 0.3" h	1.8 lb	21.1 cm x 21.1 cm x 0.8 cm	0.8 kg	12

MICROFIBER FLEXIBLE DUSTING WANDS

No.	Color	Description	U.S. Dimensions	U.S. Ship Wt/Ctn	Metric Dimensions	Metric Ship Wt/Ctn	Pack
FGQ85000	BK00	Quick-Connect Flexible Dusting Wand with Microfiber Sleeve	28.75" l x 3.25" w x 1.5" h	1.8 lb	73 cm x 8.3 cm x 3.8 cm	0.8 kg	6
FGQ85100	GR00	Wand Duster Microfiber Replacement Sleeve	22.7" l x 3.25" w x 0.75" h	1.2 lb	57.7 cm x 8.3 cm x 1.9 cm	0.5 kg	6
FGQ85200	WH00	Executive Series™ Quick-Connect Flexible Dusting Wand with High-Performance Sleeve	28.4" l x 1.13" w x 1.13" h	5.0 lb	72.1 cm x 2.9 cm x 2.9 cm	2.3 kg	6
FGQ85300	WH00	Executive Series™ Wand Duster High-Performance Microfiber Replacement Sleeve	12.3" l x 7" w x 0.74" h	2.8 lb	31.2 cm x 17.8 cm x 1.9 cm	1.3 kg	6

WHEN ORDERING PRODUCTS WITH **BOLD** COLOR CODES, PLEASE SPECIFY COLOR CODE AFTER THE PRODUCT NUMBER. REFER TO THE PRODUCT COLOR GUIDE AT THE BACK OF THE CATALOG.



Check out the items marked with this symbol for our new line of Executive Series™ products.

Rubbermaid HYGEN™ Microfiber Cloths

Industry-best microfiber cloths include scrubbing strips and high-quality knitting for better absorption and debris pickup.

- Double-finished edges provide durability and shape retention
- Durable up to 500 launderings
- Withstands up to 200°F hot water for bleach-free sanitation
- Color-coded for general purpose and special applications to help reduce cross-transmission

Rubbermaid HYGEN™ Microfiber Mitts

Double-sided hand mitts help make cleaning easier in crevices and around irregular surfaces.

- Perfect for glass and chrome cleaning, general-purpose damp cleaning, and dry dusting
- Use in pairs for added efficiency



REDUCE CROSS-TRANSMISSION

Rubbermaid HYGEN™ Microfiber Cloths are color-coded to assist in cleaning by area or task and help reduce cross-transmission.



MICROFIBER CLOTHS

Yellow, red, green, and blue cloths for cleaning by area or task.



1867398

EXECUTIVE SERIES™ MICROFIBER CLOTHS

Glass/mirror cloths for scratch-free, lint-free cleaning.



MICROFIBER HAND MITTS

For cleaning glass and chrome, general-purpose cleaning, and dry dusting.

MICROFIBER CLOTHS

No.	Color	Description	U.S. Dimensions	U.S. Ship Wt/Ctn	Metric Dimensions	Metric Ship Wt/Ctn	Pack
FGQ61000	YLOO	Microfiber Bathroom Cloth (Yellow)	16" l x 16" w	0.6 lb	40.6 cm x 40.6 cm	0.3 kg	12
FGQ61006	YLOO	Microfiber Bathroom Cloth (Yellow)	16" l x 16" w	0.54 lb	40.6 cm x 40.6 cm	0.24 kg	6
FGQ62000	GR00, RD00, BL00	Microfiber General-Purpose Cloth (Green, Red, or Blue)	16" l x 16" w	0.65 lb	40.6 cm x 40.6 cm	0.29 kg	12
FGQ62006	GR00	Microfiber General-Purpose Cloth (Green)	16" l x 16" w	0.8 lb	40.6 cm x 40.6 cm	0.4 kg	6
FGQ63000	BL00	Microfiber Glass/Mirror Cloth (Blue)	16" l x 16" w	1.8 lb	40.6 cm x 40.6 cm	0.8 kg	12
1867398	GRAY	Executive Series™ Microfiber Glass/Mirror Cloth	16" l x 16" w	1.8 lb	40.6 cm x 40.6 cm	0.8 kg	12
1863889	GRAY	Executive Series™ Multipurpose Microfiber Cloth	16" l x 16" w	0.8 lb	40.6 cm x 40.6 cm	0.4 kg	6
1863891	BROWN	Executive Series™ Multipurpose Microfiber Cloth	16" l x 16" w	0.8 lb	40.6 cm x 40.6 cm	0.4 kg	6
FGQ63006	BL00	Microfiber Glass/Mirror Cloth (Blue)	16" l x 16" w	0.5 lb	40.6 cm x 40.6 cm	0.2 kg	6
FGQ64000	GR00	Microfiber XL General-Purpose Cloth (Green)	20" l x 20" w	1.4 lb	50.8 cm x 50.8 cm	0.6 kg	12

New!
New!
New!

MICROFIBER MITTS

No.	Color	Description	U.S. Dimensions	U.S. Ship Wt/Ctn	Metric Dimensions	Metric Ship Wt/Ctn	Pack
FGQ65000	GR00	Microfiber All-Purpose Mitt with Thumb	11" l x 8.75" w	2.4 lb	27.9 cm x 22.2 cm	1.1 kg	12
FGQ65100	BL00	Microfiber Glass/Mirror Mitt with Thumb	11" l x 8.75" w	2.2 lb	27.9 cm x 22.2 cm	1 kg	12
FGQ65200	GR00	Microfiber Dusting Mitt with Thumb	11.9" l x 9.9" w	1.5 lb	30.2 cm x 25.1 cm	0.7 kg	6

Rubbermaid HYGEN™ Sanitizer-Safe Microfiber Cloth

The more durable and versatile solution for back- and front-of-house cleaning tasks.

- Cleans effectively with less chemical replenishment
- Long product life reduces wipes and cloths in landfill
- Proven to remove 99.9% of microbes
- Removes stains 30% more effectively than cotton cloths
- Launderable up to 40x
- Proprietary flexible compound will not crack or split, even when used with bleach or peroxide



New!



1874723

SANITIZER-SAFE MICROFIBER CLOTH

No.	Color	Description	U.S. Dimensions	U.S. Ship Wt/Ctn	Metric Dimensions	Metric Ship Wt/Ctn	Pack
1805727	RD00	Sanitizer-Safe Microfiber Cloth – Red	19" l x 16" w x 0.06" h	23.04 lb	48.26 cm x 40.64 cm x 0.15 cm	10.45 kg	288
1805728	BL00	Sanitizer-Safe Microfiber Cloth – Blue	19" l x 16" w x 0.06" h	23.04 lb	48.26 cm x 40.64 cm x 0.15 cm	10.45 kg	288
1805729	YL00	Sanitizer-Safe Microfiber Cloth – Yellow	19" l x 16" w x 0.06" h	23.04 lb	48.26 cm x 40.64 cm x 0.15 cm	10.45 kg	288
1805730	GR00	Sanitizer-Safe Microfiber Cloth – Green	19" l x 16" w x 0.06" h	23.04 lb	48.26 cm x 40.64 cm x 0.15 cm	10.45 kg	288
1874723	RD/BL/YL/GR	Sanitizer-Safe Microfiber Cloth – 4-Pack	7.25" l x 1.75" w x 8.0" h	4.00 lb	18.42 cm x 4.45 cm x 20.32 cm	1.82 kg	4

Rubbermaid HYGEN™ Microfiber Kit with Charging Bucket

The single source solution with all microfiber products needed to clean up to 12 patient rooms.



1784284

Rubbermaid HYGEN™ Microfiber Kit with Rubbermaid PULSE™

The single source solution designed to clean up to 10,000 square feet.



1784285

RUBBERMAID HYGEN™ MICROFIBER KITS

No.	Color	Description	U.S. Dimensions	U.S. Ship Wt/Ctn	Metric Dimensions	Metric Ship Wt/Ctn	Pack
1784284	N/A	Rubbermaid HYGEN™ Microfiber Kit with Charging Bucket	48" l x 29" w x 27" h	112.0 lb	121.9 cm x 73.7 cm x 68.6 cm	50.9 kg	1
1784285	N/A	Rubbermaid HYGEN™ Microfiber Kit with Rubbermaid PULSE™	48" l x 29" w x 27" h	112.0 lb	121.9 cm x 73.7 cm x 68.6 cm	50.9 kg	1

Kits include everything shown. For a complete display of components included with each kit, see page 82.

WHEN ORDERING PRODUCTS WITH **BOLD** COLOR CODES,
PLEASE SPECIFY COLOR CODE AFTER THE PRODUCT NUMBER.
REFER TO THE PRODUCT COLOR GUIDE AT THE BACK OF THE CATALOG.



Check out the items marked with this symbol for our new line of Executive Series™ products.

Microfiber Light Commercial Cloths

Quality microfiber products for less demanding users.

- Microfiber mops and cloths withstand hundreds of launderings
- Hook-and-loop backing attaches pads securely to frame



FGQ55900



1863888

1863890



1820580



1868698



1868697



FGQ74900

No.	Color	Description	U.S. Ship Wt/Ctn	Metric Ship Wt/Ctn	Pack
1868698	GREEN	18" (45.7 cm) Microfiber Fringed Dust Mop	2.9 lb	1.3 kg	12
1868697	BLUE	18" (45.7 cm) Microfiber Damp Mop	3.0 lb	1.4 kg	12
FGQ55900	BK00	18" (45.7 cm) Economy Quick-Connect Wet/Dry Plastic Frame	6.1 lb	2.8 kg	6
1820577	PINK	12" x 12" Microfiber Light Commercial Cloth	13.8 lb	6.3 kg	288
1820578	GREEN	12" x 12" Microfiber Light Commercial Cloth	13.8 lb	6.3 kg	288
1820579	BLUE	12" x 12" Microfiber Light Commercial Cloth	13.8 lb	6.3 kg	288
1820580	YELLOW	12" x 12" Microfiber Light Commercial Cloth	13.8 lb	6.3 kg	288
New! 1863888	GRAY	Executive Series™ 12" x 12" Microfiber Light Commercial Cloth	13.8 lb	6.3 kg	288
New! 1863890	BROWN	Executive Series™ 12" x 12" Microfiber Light Commercial Cloth	13.8 lb	6.3 kg	288
1820581	PINK	16" x 16" Microfiber Light Commercial Cloth	13.8 lb	6.3 kg	288
1820582	GREEN	16" x 16" Microfiber Light Commercial Cloth	13.8 lb	6.3 kg	288
1820583	BLUE	16" x 16" Microfiber Light Commercial Cloth	13.8 lb	6.3 kg	288
1820584	YELLOW	16" x 16" Microfiber Light Commercial Cloth	13.8 lb	6.3 kg	288
FGQ74900	YL00	52" (132 cm) Economy Quick-Connect Steel Handle	7.1 lb	3.2 kg	6

Professional Spray Mop

Lighter-duty spray mop streamlines the mopping process for improved productivity.



3486110 Replacement Refill Cartridges hold cleaners for different floor surfaces.



3486108



Easy to fill and replace Cartridges.

No.	Color	Description	U.S. Dimensions	U.S. Ship Wt/Ctn	Metric Dimensions	Metric Ship Wt/Ctn	Pack
3486108	N/A	Professional Spray Mop (mop not included)	52" l x 4.5" w x 3.5" h	3.0 lb	132.1 cm x 11.4 cm x 8.9 cm	1.4 kg	1
3486110	N/A	15 oz Replacement Refill Cartridge	3.25" l x 2.75" w x 8.75" h	2.4 lb	8.3 cm x 7.0 cm x 22.2 cm	1.1 kg	6
1868697	BLACK	18" Economy Microfiber Damp Mop	19.5" l x 4.5" w x 0.3" h	3.0 lb	49.53 cm x 11.43 cm x 0.76 cm	1.4 kg	12

Rubbermaid FLOW™ Finishing Systems

Help reduce labor costs and improve worker productivity and well-being with the highly portable Rubbermaid FLOW™ Floor Finishing System. High-capacity backpack and handle system allows user-controlled release of solution for more efficient floor finishing.



CLEAN CONNECT™ TECHNOLOGY

Backpack hose connects to the trigger handle using Clean Connect™ technology for spill-free delivery of finish solution.

HIGH CAPACITY BACKPACK SYSTEM

Rubbermaid FLOW™ holds 1.5 gallons for finishing up to 3,000 sq ft of floor surface. The 3" diameter opening makes refilling easy.

STRING MOP OR FLAT MOP OPTIONS

Kit includes either a FGQ20000 Rubbermaid FLOW™ Nylon String Mop or a FGQ80500 Rubbermaid FLOW™ Nylon Flat Mop. Both connect easily to the handle using Quick-Connect.

TRIGGER HANDLE

Red ergonomic trigger handle dispenses finish solution with each press.

IMPROVED COMFORT

Backpack features venting channels to improve airflow and reduce moisture on back while wearing.

PROTECTS WORKER WELL-BEING

Chest and waist straps distribute weight onto user's hips instead of shoulders, reducing user strain.



FGQ97900 RUBBERMAID FLOW™ FLAT MOP FINISH KIT

INCLUDES:

Backpack, Trigger Handle, 18" Quick-Connect Frame, and FGQ80500 Rubbermaid FLOW™ Nylon Flat Mop



FGQ98900 RUBBERMAID FLOW™ STRING MOP FINISH KIT

INCLUDES:

Backpack, Trigger Handle, and FGQ20000 Rubbermaid FLOW™ Nylon String Mop

No.	Color	Description	U.S. Dimensions	U.S. Capacity	U.S. Ship Wt/Ctn	Metric Dimensions	Metric Capacity	Metric Ship Wt/Ctn	Pack
FGQ97900	YLOO	Rubbermaid FLOW™ Flat Mop Finish Kit	56" l x 9.75" w x 3.75" h	1.5 gal	8.2 lb	142.2 cm x 24.8 cm x 9.5 cm	5.7 L	3.7 kg	1
FGQ98900	YLOO	Rubbermaid FLOW™ String Mop Finish Kit	56" l x 9.75" w x 3.75" h	1.5 gal	7.5 lb	142.2 cm x 24.8 cm x 9.5 cm	5.7	3.4 kg	1
FGQ20000	WH00	Rubbermaid FLOW™ Nylon String Mop	17" l x 14.75" w x 8.5" h	N/A	8.9 lb	43.2 cm x 37.5 cm x 21.6 cm	N/A	4 kg	6
FGQ80500	WH00	Rubbermaid FLOW™ Nylon Flat Mop	6.5" l x 3.15" w x 19.7" h	N/A	5 lb	16.5 cm x 8 cm x 50 cm	N/A	2.3 kg	6
FGQ97700	0000	Rubbermaid FLOW™ Replacement Bladder	20" l x 6" w x 0.4" h	1.5 gal	2.4 lb	50.8 cm x 15.2 cm x 1 cm	5.7 L	1.1 kg	2

WHEN ORDERING PRODUCTS WITH **BOLD** COLOR CODES, PLEASE SPECIFY COLOR CODE AFTER THE PRODUCT NUMBER. REFER TO THE PRODUCT COLOR GUIDE AT THE BACK OF THE CATALOG.



Check out the items marked with this symbol for our new line of Executive Series™ products.

Microfiber Flat Mop Finishing

FINISH BUCKET

Same features as the Microfiber Press Wring Bucket, in the blue color most often associated with finish applications.

FINISH PAD

Produce beautiful, professional results easier and more quickly than traditional methods.

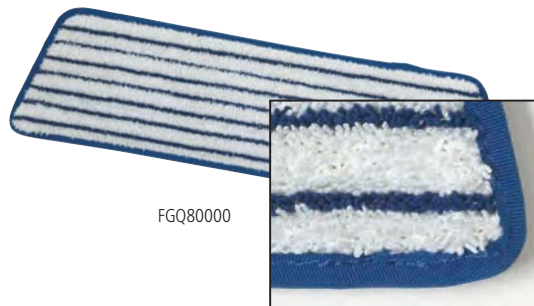

FGQ93000

FGQ80000

No.	Color	Description	U.S. Dimensions	U.S. Ship Wt/Ctn	Metric Dimensions	Metric Ship Wt/Ctn	Pack
FGQ80000	WH00	18" (45.7 cm) Microfiber Finish Pad	18" l x 5.5" w x 0.5" h	1.9 lb	45.7 cm x 14 cm x 1.3 cm	0.9 kg	6
FGQ93000	BLUE	Finish Bucket	14.7" l x 26.2" w x 16.2" h	12.1 lb	37.3 cm x 66.5 cm x 41.1 cm	5.5 kg	1

Microfiber Finish System

Helps ensure controlled absorption and release of finish.

- Delivers 200–300 square feet (18.6 m²-27.9 m²) of coverage with a single mop load of finish
- Split microfiber for the fastest and smoothest finish application
- Resealable Finish Bucket (FGQ93000) keeps finish fresh until the next job, saving cleanup time
- Smooth, nonporous bucket cleans easily, reducing time spent on stripping traditional mop bucket/wringer combinations



No.	Color	Description	U.S. Mop Size	U.S. Capacity	U.S. Ship Wt/Ctn	Metric Mop Size	Metric Capacity	Metric Ship Wt/Ctn	Pack
FGQ05000	0000	Microfiber Finish System, Includes Bucket with Lid, Sieve, 8 Pads, 1 Frame	18" l x 5" w	22 qt	10.6 lb	45.7 cm x 12.7 cm	20.8 L	4.8 kg	1
FGE05200	WH00	Finish Mop, Looped Fringe	18" l x 5" w	N/A	5.0 lb	45.7 cm x 12.7 cm	N/A	2.3 kg	6

Overhead Dusting Tools

A sensible solution to routine overhead dusting.

- Heads are launderable for long product life
- Telescoping handle allows simple and efficient overhead use
- The FGT13000 extends up to 102" (8½ feet/2.6 m) to reach high areas



FGT12000

No.	Color	Description	U.S. Ship Wt/Ctn	Metric Ship Wt/Ctn	Pack
FGT11000	GY00	Overhead Dusting Tool with Launderable Head, 51" l (129.5 cm) Extension Handle	8.0 lb	3.6 kg	12
FGT12000	GY00	Overhead Dusting Tool with Angled Launderable Head, 51" l (129.5 cm) Extension Handle	8.0 lb	3.6 kg	12
FGT13000	GY00	Overhead Dusting Tool with Launderable Head, 8½' l (2.6 m) Extension Handle	17.0 lb	7.7 kg	12
FGT19900	WH00	Overhead Dusting Tool Replacement Head fits FGT11000, FGT12000, FGT13000	4.0 lb	1.8 kg	12

Flexible Head Overhead Dusting Tools

Flexible head adjusts to match surface.

- Flexible head conforms to virtually any shape for more efficient cleaning
- Launderable Dust Mitt can be worn on the hand or used with the Flexible Head Dusting Tool
- FGT41000 Dusting Tool and FGT49900 Dust Mitt are sold separately
- FGQ65200 Microfiber Dusting Mitt fits FGT41000 Dusting Tool



FGT41000 / FGT49900

No.	Color	Description	U.S. Ship Wt/Ctn	Metric Ship Wt/Ctn	Pack
FGT41000	0000	Flexible-Head Overhead Dusting Tool, Flexible Head with 60" l (152.4 cm) Aluminum Handle	8.0 lb	3.6 kg	6
FGT49900	WH00	Dust Mitt Off-Floor Dusting Tool, Cotton	5.0 lb	2.3 kg	12

Lambswool Duster

Fast, effective surface dusting.

- 100% lambswool duster
- Ideal for dusting large areas quickly and effectively



FG9C0400

No.	Color	Description	U.S. Ship Wt/Ctn	Metric Ship Wt/Ctn	Pack
FG9C0400	0000	30"-42" (76.2 cm–106.6 cm) Lambswool Duster with Telescoping Plastic Handle	1.8 lb	0.8 kg	6

WHEN ORDERING PRODUCTS WITH **BOLD** COLOR CODES,
PLEASE SPECIFY COLOR CODE AFTER THE PRODUCT NUMBER.
REFER TO THE PRODUCT COLOR GUIDE AT THE BACK OF THE CATALOG.



Check out the items marked with this symbol for our new line of Executive Series™ products.

WAVEBRAKE®

WaveBrake's revolutionary bucket shape with molded-in wave breaks reduces splashing up to 40% for safer, easier, and more efficient mopping.



WaveBrake® Mopping Systems

Rubbermaid is the world's leading manufacturer of mop buckets.

Improve productivity and help reduce labor costs! WaveBrake® Mopping Systems reduce splashing for safer, easier, and more efficient mopping. WaveBrake® Mopping Systems can handle any mopping job with ease, in sizes from 26 quarts to 44 quarts.



DIRTY WATER BUCKET

- Separates dirty water from clean water
- Preserves the quality and cleaning power of cleaning solution
- Reduces water and chemical usage
- Helps produce cleaner, less slippery floors
- Divides liquid weight; less lifting power needed when emptying buckets



HOW IT WORKS

Traditionally, wringers release dirty water directly back into the bucket's primary cleaning water.

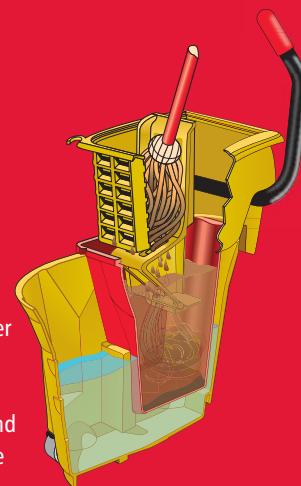

Rubbermaid's Dirty Water Bucket nests below the WaveBrake® Wringer to collect the dirty water and keep it separate from the cleaning solution.

WaveBrake® 35-Qt High-Performance Mopping Systems

Enhanced features for greater performance.

- Tested to exceed 40,000 wringing cycles*
- Premium tubular steel and structural web molded plastic
- WaveBrake® buckets work with Rubbermaid® High-Capacity and Rubbermaid HYGEN™ Cleaning Carts
- Accepts optional dirty water bucket
- Executive Series™ Wavebrake® models feature Quiet Casters and Dirty Water Buckets (not shown, see page 63).

*Based on internal testing

See it in
ACTION

www.rubbermaidwavebrake.com



FG758888

COLOR-CODED FOR SPECIALIZED CLEANING

WaveBrake® Side Press and Down Press Combos are color-coded for easy separation of cleaning by room or area and help reduce cross-contamination.



FG758088 Side Press Combo with FG9C7400 Dirty Water Bucket



FG758088, 1863897, 1863896
Side Press Combo



FG757788, 1863898, 1863899
Down Press Combo



FG759088
Institutional Combo
(with no metal components)



FG757900
Institutional Combo
(does not include
bail or spring)

No.	Color	Description	U.S. Dimensions	U.S. Ship Wt	U.S. Capacity	Metric Dimensions	Metric Ship Wt	Metric Capacity	Pack
FG758088	YEL, BRN	WaveBrake® Side Press Combo	20.1" l x 15.7" w x 36.5" h	19.5 lb	35 qt	51.1 cm x 39.9 cm x 92.7 cm	8.8 kg	33.1 L	1
1863896	BLACK	Executive Series™ WaveBrake® Side Press Combo	20.1" l x 15.7" w x 36.5" h	19.5 lb	35 qt	51.1 cm x 39.9 cm x 92.7 cm	8.8 kg	33.1 L	1
1863897	GRAY	Executive Series™ WaveBrake® Side Press Combo	20.1" l x 15.7" w x 36.5" h	19.5 lb	35 qt	51.1 cm x 39.9 cm x 92.7 cm	8.8 kg	33.1 L	1
FG757788	YEL, BRN	WaveBrake® Down Press Combo	20.1" l x 15.7" w x 36.5" h	21.2 lb	35 qt	51.1 cm x 39.9 cm x 92.7 cm	9.6 kg	33.1 L	1
1863898	BLACK	Executive Series™ WaveBrake® Down Press Combo	20.1" l x 15.7" w x 36.5" h	21.2 lb	35 qt	51.1 cm x 39.9 cm x 92.7 cm	9.6 kg	33.1 L	1
1863899	GRAY	Executive Series™ WaveBrake® Down Press Combo	20.1" l x 15.7" w x 36.5" h	21.2 lb	35 qt	51.1 cm x 39.9 cm x 92.7 cm	9.6 kg	33.1 L	1
FG758888	RED, GRN, BLUE	WaveBrake® Side Press Combo	20.1" l x 15.7" w x 36.5" h	19.5 lb	35 qt	51.1 cm x 39.9 cm x 92.7 cm	8.8 kg	33.1 L	1
FG757888	RED, GRN, BLUE	WaveBrake® Down Press Combo	20.1" l x 15.7" w x 36.5" h	21.2 lb	35 qt	51.1 cm x 39.9 cm x 92.7 cm	9.6 kg	33.1 L	1
FG757900	YEL, BRN	WaveBrake® Down Press Institutional Combo	20.1" l x 15.7" w x 36.5" h	14.2 lb	35 qt	51.1 cm x 39.9 cm x 92.7 cm	6.4 kg	33.1 L	1
FG759088	YEL	WaveBrake® Institutional Combo	18.6" l x 15.9" w x 24.7" h	14.2 lb	35 qt	47.2 cm x 40.4 cm x 62.7 cm	6.4 kg	33.1 L	1

WHEN ORDERING PRODUCTS WITH **BOLD** COLOR CODES,
PLEASE SPECIFY COLOR CODE AFTER THE PRODUCT NUMBER.
REFER TO THE PRODUCT COLOR GUIDE AT THE BACK OF THE CATALOG.



Check out the items marked with this symbol for our new line of Executive Series™ products.

WaveBrake® 35-Qt Mopping Trolleys

Value-added features make this an ideal compact janitor cart.

- Includes two Dirty Water Buckets and Maid Caddy
- Comfortable, upright trolley handle for easy maneuverability
- Glides smoothly on Quiet Caster trolley
- Includes all the features of our high-quality 35-Qt WaveBrake® Bucket
- Can accommodate a tall kitchen can liner when Maid Caddy is removed



FG778000 Side Press Mopping Trolley with optional accessories.

No.	Color	Description	U.S. Dimensions	U.S. Ship Wt	U.S. Capacity	Metric Dimensions	Metric Ship Wt	Metric Capacity	Pack
FG778000	YEL	WaveBrake® Mopping Trolley Side Press	28.9" l x 18.2" w x 38.6" h	38.0 lb	35 qt	73.4 cm x 46.2 cm x 98 cm	17.2 kg	33.1 L	1
FG777700	YEL, RED, GRN, BLUE	WaveBrake® Mopping Trolley Down Press	28.9" l x 18.2" w x 38.6" h	41.1 lb	35 qt	73.4 cm x 46.2 cm x 98 cm	18.6 kg	33.1 L	1

WaveBrake® 35-Qt Dual-Water Mopping Combos

Includes Dirty Water Bucket and Quiet Caster Dolly.

- Includes Dirty Water Bucket for keeping dirty water separate from clean water
- Glides smoothly on Quiet Caster Dolly
- Includes all the features of our high-quality 35-Qt WaveBrake® Bucket
- Connects with Lock 'N Go feature on Rubbermaid® High-Capacity and Rubbermaid HYGEN™ Cleaning Carts (see pages 98–99)

See it in ACTION
www.rubbermaidwavebrake.com



FG767700 Dual- Water Down Press Combo

No.	Color	Description	U.S. Dimensions	U.S. Ship Wt	U.S. Capacity	Metric Dimensions	Metric Ship Wt	Metric Capacity	Pack
FG768000	YEL	WaveBrake® Dual-Water Side Press Combo	22.4" l x 16.5" w x 38.6" h	25.5 lb	35 qt	56.9 cm x 41.9 cm x 98 cm	11.6 kg	33.1 L	1
FG767700	YEL	WaveBrake® Dual-Water Down Press Combo	22.4" l x 16.5" w x 38.6" h	27.4 lb	35 qt	56.9 cm x 41.9 cm x 98 cm	12.4 kg	33.1 L	1

WaveBrake® 44-Qt Mopping System

High-capacity 44-Quart WaveBrake® mop bucket and wringer system makes easy work of even the largest mopping jobs.

- Holds up to 44-quarts for high-capacity mopping
- Innovative foot pedal water-release mechanism for easy emptying
- Accepts WaveBrake® Dirty Water Bucket FG9C7400
- Tested to exceed 40,000 wringing cycles*
- Premium tubular steel and structural web molded plastic
- Removable casters

*Based on internal testing



FOOT PEDAL WATER RELEASE

Innovative foot pedal water-release mechanism eliminates the need to lift the bucket during emptying and helps reduce back strain.

See it in
ACTION

www.rubbermaidwavebrake.com



FG757688

No.	Color	Description	U.S. Dimensions	U.S. Ship Wt	U.S. Capacity	Metric Dimensions	Metric Ship Wt	Metric Capacity	Pack
FG618688	YEL	WaveBrake® 44-Qt Side Press Combo	24" l x 17" w x 38" h	20.5 lb	44 qt	61 cm x 43.2 cm x 96.5 cm	9.3 kg	41.6 L	1
FG757688	YEL	WaveBrake® 44-Qt Down Press Combo	24" l x 17" w x 38" h	21.3 lb	44 qt	61 cm x 43.2 cm x 96.5 cm	9.7 kg	41.6 L	1

WaveBrake® 26-Qt Mopping System

Compact size for efficient cleaning.

- Side Press wrings mops with less effort
- Tested to exceed 40,000 wringing cycles*
- Premium tubular steel and structural web molded plastic
- Accepts 32-oz mops

*Based on internal testing



FG748018

No.	Color	Description	U.S. Dimensions	U.S. Ship Wt	U.S. Capacity	Metric Dimensions	Metric Ship Wt	Metric Capacity	Pack
FG748018*	YEL	WaveBrake® Side Press Combo	18.6" l x 15.6" w x 16.7" h	22.75 lbs	26 qt	47.2 cm x 39.6 cm x 42.4 cm	10.3 kg	25 L	12

*Pallet Pack

WHEN ORDERING PRODUCTS WITH **BOLD** COLOR CODES,
PLEASE SPECIFY COLOR CODE AFTER THE PRODUCT NUMBER.
REFER TO THE PRODUCT COLOR GUIDE AT THE BACK OF THE CATALOG.



Check out the items marked with this symbol for our new line of Executive Series™ products.

WaveBrake® Mopping System Accessories



FG9C7300*



FG757088



FG9C7400



1863900



FG757588



FG612788

WAVEBRAKE® BUCKETS

No.	Color	Description	U.S. Dimensions	U.S. Ship Wt	U.S. Capacity	Metric Dimensions	Metric Ship Wt	Metric Capacity	Pack
FG747000	YEL	WaveBrake® Bucket	18.6" l x 15.9" w x 16.7" h	37.1 lb	26 qt	47.2 cm x 40.4 cm x 42.4 cm	16.8 kg	25 L	4
FG757088	YEL, RED, GRN, BRN, BLUE*	WaveBrake® Bucket	20.1" l x 16" w x 17.4" h	40.1 lb	35 qt	51.1 cm x 40.6 cm x 44.2 cm	18.2 kg	33.1L	4
FG757188	YEL, RED, GRN, BLUE	WaveBrake® Bucket, no Casters	20.1" l x 16" w x 16" h	35.6 lb	35 qt	51.1 cm x 40.6 cm x 40.6 cm	16.1 kg	33.1L	4
FG757079	YEL, RED, GRN, BLUE	WaveBrake® Bucket, no Casters	20.1" l x 16" w x 17.4" h	40.1 lb	35 qt	51.1 cm x 40.6 cm x 44.2 cm	18.2 kg	33.1L	4

WAVEBRAKE® WRINGERS

No.	Color	Description	U.S. Dimensions	U.S. Ship Wt	U.S. Capacity	Metric Dimensions	Metric Ship Wt	Metric Capacity	Pack
FG612788	YEL, RED, GRN, BRN, BLUE*	Side Press Wringer for WaveBrake® Mop Buckets	13" l x 13" w x 27" h	19.5 lb	12-32 oz	33 cm x 33 cm x 68.6 cm	8.8 kg	.3-.9 kg	2
FG757579	YEL, RED, GRN, BRN, BLUE	Down Press Wringer for WaveBrake® Bucket	13.5" l x 13.2" w x 27" h	6.23 lb	N/A	34.3 cm x 33.5 cm x 68.6 cm	2.8 kg	N/A	2
FG757588	YEL, RED, GRN, BRN, BLUE	Down Press Wringer for WaveBrake® Bucket	13.5" l x 13.2" w x 27" h	22.1 lb	16-32 oz	34.3 cm x 33.5 cm x 68.6 cm	10 kg	.5-.9 kg	2

WAVEBRAKE® ACCESSORIES

New!



No.	Color	Description	U.S. Dimensions	U.S. Ship Wt	U.S. Capacity	Metric Dimensions	Metric Ship Wt	Metric Capacity	Pack
FG9C7400	YEL, RED	Dirty Water Bucket for WaveBrake® Combos	14.1" l x 9.9" w x 14.1" h	17 lb	18 qt	35.8 cm x 25.1 cm x 35.8 cm	7.7 kg	17 L	6
1863900	GRAY	Executive Series™ Dirty Water Bucket for WaveBrake® Combos	14.1" l x 9.9" w x 14.1" h	17 lb	18 qt	35.8 cm x 25.1 cm x 35.8 cm	7.7 kg	17 L	6
FG9C7300	BLA*	Quiet Caster Dolly	22.4" l x 16.5" w x 6.2" h	10.1 lb	N/A	56.9 cm x 41.9 cm x 15.7 cm	4.6 kg	N/A	2

*Requires 4 weeks lead time and are nonreturnable. *For use with 35-Qt WaveBrake® Systems only.

Tandem™ 31-Qt Bucket and Wringer Combo

All-in-one compact design for effective wringing and no more lost parts.

- One-piece design: integrated bucket and wringer
- Holes in both wringing plates force more water from mop in less time
- 2½" casters for excellent maneuverability
- Built-in lift handles on bottom of bucket make lifting and emptying easier
- Accepts up to 24-oz. mops



FG738000

No.	Color	Description	U.S. Dimensions	U.S. Ship Wt	U.S. Capacity	Metric Dimensions	Metric Ship Wt	Metric Capacity	Pack
FG738000	YEL	Tandem™ 31-Qt Bucket and Wringer Combo	22.63" l x 13.25" w x 32.25" h	11.8 lb	31 qt	57.5 cm x 33.7 cm x 81.9 cm	5.4 kg	29 L	1



WET MOPPING

There are several important factors to consider when choosing a wet mop. Use the guidelines on the following pages to choose the best wet mop for your floor care needs.

GENERAL MOPPING

Choose mops with high absorbency, release, and durability. If laundering is available, launderable mops will be the most economical choice. Microfiber, synthetic, rayon, and blended fiber mops with looped ends and woven tailbands offer the best performance and launderability.

FINISH MOPPING

Look for microfiber, rayon, or synthetic mops for high absorbency and release. Construction features such as tailbands and looped ends provide for better floor coverage and less streaking.

LAUNDERABILITY/DURABILITY

The launderability of a mop is based on the number of commercial washing and drying cycles it can withstand before the construction of the mop is degraded or the performance declines. The durability of a mop is a measure of how long it will perform before needing to be replaced. Microfiber, synthetic, and blended fiber mops have the highest levels of launderability and are the most durable.



MICROFIBER



SYNTHETIC



BLEND



RAYON

ABSORBENCY

The absorbency of a mop refers to its ability to pick up and hold liquid. Higher levels allow faster floor drying times, leading to greater productivity and worker safety. Microfiber, rayon, and cotton yarns have the highest absorbency.



MICROFIBER



RAYON



COTTON



BLEND

RELEASE

Release is the ability of a mop to disperse liquid onto the floor or during wringing. Higher levels allow faster and more complete wringing, as well as more efficient application of cleaning solutions on the floor. Microfiber, rayon, and synthetic yarns offer the best release of liquids.



MICROFIBER



RAYON



SYNTHETIC



BLEND

CLEANING POWER

Cleaning power is the ability of a mop to remove dirt from the floor.



MICROFIBER



ANTIMICROBIAL



SYNTHETIC



BLEND



Wet Mop Selection Guide

Use the following guide to choose the best Rubbermaid Commercial Products' Wet Mops for your facility.

Environment	Launderability	VINYL TILE, LAMINATE, SMOOTH CERAMIC TILE	ANTI-SLIP TILE, TERRAZZO, PAVER, AND QUARRY STONE	RUBBER, HARDWOOD, SMOOTH CONCRETE
HEALTHCARE FACILITIES	Premium Launderable Standard Launderable Nonlaunderable/Disposable	Web Foot® Microfiber, Web Foot® Swinger Loop® Cut-End Rayon	Rough-Floor Mop Swinger Loop® Synthetic Blend	Web Foot® Swinger Loop® Super Stitch
EDUCATIONAL FACILITIES	Premium Launderable Standard Launderable Nonlaunderable/Disposable	Web Foot® Microfiber, Web Foot® Universal Economy Cotton	Rough-Floor Mop Swinger Loop® Synthetic Blend	Web Foot® Universal Economy Cotton
INDUSTRIAL and COMMERCIAL	Premium Launderable Standard Launderable Limited Launderability Nonlaunderable/Disposable	Web Foot® Microfiber, Web Foot® Swinger Loop® Super Stitch® Cut-End Cotton	Rough-Floor Mop Swinger Loop® Super Stitch® Synthetic Blend	Web Foot® Swinger Loop® Super Stitch® Cut-End Cotton
FOODSERVICE	Premium Launderable Standard Launderable Limited Launderability Nonlaunderable/Disposable	Web Foot® Microfiber, Web Foot® Swinger Loop® Super Stitch® Cut-End Blend	Rough-Floor Mop Swinger Loop® Super Stitch® Synthetic Blend	Web Foot® Swinger Loop® Super Stitch® Synthetic Blend
OFFICE BUILDINGS	Premium Launderable Standard Launderable Limited Launderability Nonlaunderable/Disposable	Web Foot® Microfiber, Web Foot® Swinger Loop® Super Stitch® Cut-End Cotton	Rough-Floor Mop Swinger Loop® Super Stitch® Synthetic Blend	Web Foot® Swinger Loop® Super Stitch® Cut-End Cotton
HOSPITALITY	Premium Launderable Standard Launderable Limited Launderability Nonlaunderable/Disposable	Web Foot® Microfiber, Web Foot® Swinger Loop® Super Stitch® Cut-End Blend	Rough-Floor Mop Swinger Loop® Super Stitch® Synthetic Blend	Web Foot® Swinger Loop® Super Stitch® Cut-End Blend

FOR ANY ENVIRONMENT:	STRIPPING	FINISHING
Best	Super Stitch®	Nylon Finish
Better	Premium Cut-End	Web Foot® Finish
Good	Economy Cotton	Super Stitch® Finish

Premium Launderable: Launder and reuse on average 75–200 times.
 Standard Launderable: Launder and reuse up to 50 times.
 Limited Launderability: Up to five launderings.
 Nonlaunderable/Disposable: Laundering not recommended; hand wash or bucket wash and wring.

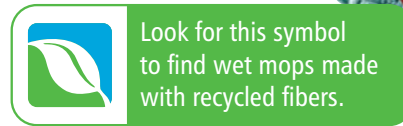

MOP CONSTRUCTION FEATURES



WOVEN TAILBANDS
 Holds yarn in place for greater floor coverage and improved launderability.



YARN TAILBANDS
 Provides greater floor coverage for more efficient cleaning.



PVC-COATED MESH HEADBANDS
 Resists chemicals and prohibits moisture retention so strands dry thoroughly.



WOVEN HEADBANDS
 Allows thorough drying of mop strands for longer product life.



LOCKED POLYESTER THREAD STITCHING
 High-quality stitching for better durability and longer product life.



LOOPED ENDS
 Reduces fraying and deplying for better durability and longer product life.



CUT ENDS
 Economical construction for general-purpose mopping. Laundering is not recommended.



5" HEADBAND
 For use with Gripper® clamp-style mop handles.



1" HEADBAND
 For use with Invader® side-gate-style mop handles.



BOLT-ON HEADBAND
 Traditional construction.

Web Foot® Microfiber Tube Mops

Designed to have greater floor contact and improved absorbency.

- Constructed with a blend of continuous-filament microfiber and polyester
- Triple the durability and withstands three times the number of launderings of standard-blend mops
- Superior absorbency and release characteristics
- Tube design reduces drag for increased productivity
- Works with all traditional wet mop handles and frames
- Recycled content: up to 50% PET Plastic
- Premium launderability, up to 200 launderings



FOR MICROFIBER FLAT MOPS,
SEE MICROFIBER MOPS.



FGT81306

No.	Mop Color	Description	U.S. Headband Size	U.S. Ship Wt/Ctn	Mop Size	Metric Headband Size	Metric Ship Wt/Ctn	Pack
FGT81206	GR00	Web Foot® Microfiber Tube Mop	1"	4.5 lb	Medium	2.5 cm	2 kg	6
FGT81306	GR00	Web Foot® Microfiber Tube Mop	1"	4.8 lb	Large	2.5 cm	2.2 kg	6
FGT85206	GR00	Web Foot® Microfiber Tube Mop	5"	4.5 lb	Medium	12.7 cm	2 kg	6
FGT85306	GR00	Web Foot® Microfiber Tube Mop	5"	4.8 lb	Large	12.7 cm	2.2 kg	6

Web Foot® Microfiber String Mops

Highly durable and absorbent for extra-long mop life.

- Constructed with a blend of continuous-filament microfiber and antimicrobial yarn
- Double the durability and withstands twice the number of launderings of standard-blend mops
- Recycled content: up to 20% post-industrial cotton and 27% PET plastic
- Works with all traditional wet mop handles and frames
- Premium launderability, up to 100 launderings



FGA81306

No.	Mop Color	Description	U.S. Headband Size	U.S. Ship Wt/Ctn	Mop Size	Metric Headband Size	Metric Ship Wt/Ctn	Pack
FGA81206*	GR00	Web Foot® Microfiber String Mop	1"	5.25 lb	Medium	2.5 cm	2.4 kg	6
FGA81306*	GR00	Web Foot® Microfiber String Mop	1"	7.13 lb	Large	2.5 cm	3.2 kg	6
FGA85206	GR00	Web Foot® Microfiber String Mop	5"	5.25 lb	Medium	12.7 cm	2.4 kg	6
FGA85306	GR00	Web Foot® Microfiber String Mop	5"	7.13 lb	Large	12.7 cm	3.2 kg	6

*Available in Bolt-On Headband 6-pack (11)



21 MILLION AND COUNTING . . .

Rubbermaid Commercial Products keeps more than 21 million 16-oz plastic soda bottles out of landfills each year! Visit www.rubbermaidcommercial.com to learn more about sustainability initiatives from Rubbermaid Commercial Products.

PET Recycling of PET bottles is the collection, sorting, and processing of bottles made out of polyethylene terephthalate (PET).

PIC Post-industrial cotton is recovered cotton from manufacturing and converting processes that is diverted from the landfill for the purpose of recycling.

*With the exception of Web Foot® Microfiber Tube Mops.

HANDLES FOR ALL OF THESE MOPS CAN BE FOUND ON PAGES 75–76.

WHEN ORDERING PRODUCTS WITH **BOLD** COLOR CODES,
PLEASE SPECIFY COLOR CODE AFTER THE PRODUCT NUMBER.
REFER TO THE PRODUCT COLOR GUIDE AT THE BACK OF THE CATALOG.

SEE WET MOP SELECTION
GUIDE ON PAGE 64.

Web Foot® Mops

Web Foot® offers the best performance in the industry with maximum absorbency, ultimate durability, fast drying, and superior launderability.

- Contains antimicrobial product protection to inhibit the growth of bacteria that causes odors and stains and shortens useful product life
- Looped ends and tailbands reduce tangling for like-new performance after every laundering
- Prelaundered and preshrunk for longer product life
- Colorfast colors will not fade with repeated launderings
- Suitable for healthcare and general commercial maintenance applications
- Premium launderability, up to 75 launderings

BUILT-IN ANTIMICROBIAL PROTECTION

Rubbermaid Commercial Products was the first to spin antimicrobials directly into the mop yarn itself. Web Foot® Mops contain built-in antimicrobial protection for superior performance and product life.

Web Foot® Shrinkless Wet Mops

- Balanced 4-ply blend of cotton and synthetic yarn is prelaundered
- Woven tailband allows the mop to cover more floor area per stroke, saving time and money
- PVC-coated mesh headband prohibits moisture penetration and resists chemicals
- Recycled content: colors are up to 35% post-industrial cotton and 45% PET plastic; white is up to 35% post-industrial cotton



No.	Mop Color	Description	U.S. Headband Size	U.S. Ship Wt/Ctn	Mop Size	Metric Headband Size	Metric Ship Wt/Ctn	Headband Color	Pack
FGA21106	GR00, WH00, BL00	Web Foot® Shrinkless® Wet Mop	1"	5.8 lb	Small	2.5 cm	2.6 kg	YEL	6
FGA21206	GR00, WH00, BL00	Web Foot® Shrinkless® Wet Mop	1"	7.6 lb	Medium	2.5 cm	3.4 kg	GRN	6
FGA21306	GR00, WH00, BL00	Web Foot® Shrinkless® Wet Mop	1"	10.8 lb	Large	2.5 cm	4.9 kg	RED	6
FGA25106	GR00, WH00, BL00, OR00	Web Foot® Shrinkless® Wet Mop	5"	5.9 lb	Small	12.7 cm	2.7 kg	YEL	6
FGA25206	GR00, WH00, BL00, OR00	Web Foot® Shrinkless® Wet Mop	5"	7.7 lb	Medium	12.7 cm	3.5 kg	GRN	6
FGA25306	GR00, WH00, BL00, OR00	Web Foot® Shrinkless® Wet Mop	5"	11.0 lb	Large	12.7 cm	5 kg	RED	6

Web Foot® Wet Mops

- Balanced blend of cotton and synthetic fibers delivers up to five times the absorbency of cotton mops
- Looped-end, open-twist yarn reduces linting
- Woven tailband covers more floor area per stroke
- Recycled content: colors are up to 35% post-industrial cotton and 45% PET plastic; white is up to 35% post-industrial cotton
- Shipped as compact mop packages
- Premium launderability, up to 75 launderings



No.	Mop Color	Description	U.S. Headband Size	U.S. Ship Wt/Ctn	Mop Size	Metric Headband Size	Metric Ship Wt/Ctn	Headband Color	Pack
FGA11106	GR00, WH00, BL00, OR00	Web Foot® Wet Mop	1"	4.5 lb	Small	2.5 cm	2 kg	YEL	6
FGA11206	GR00, WH00, BL00, OR00	Web Foot® Wet Mop	1"	6.0 lb	Medium	2.5 cm	2.7 kg	GRN	6
FGA11306	GR00, WH00, BL00, OR00	Web Foot® Wet Mop	1"	8.6 lb	Large	2.5 cm	3.9 kg	RED	6
FGA15106	GR00, WH00, BL00, OR00	Web Foot® Wet Mop	5"	4.5 lb	Small	12.7 cm	2 kg	YEL	6
FGA15206	GR00, WH00, BL00, OR00	Web Foot® Wet Mop	5"	6.0 lb	Medium	12.7 cm	2.7 kg	GRN	6
FGA15306	GR00, WH00, BL00, OR00	Web Foot® Wet Mop	5"	8.6 lb	Large	12.7 cm	3.9 kg	RED	6

Web Foot® Finish Mops

- Looped-end 4-ply synthetic yarn is designed for a controlled release of floor finish
- Tailband is sewn on the inside of mop and helps reduce the "drag" patterns common to most finish mops
- Recycled content: up to 74% PET plastic
- Shipped as compact mop packages
- Premium launderability, up to 75 launderings



No.	Mop Color	Description	U.S. Headband Size	U.S. Ship Wt/Ctn	Mop Size	Metric Headband Size	Metric Ship Wt/Ctn	Headband Color	Pack
FGA41206	WH00	Web Foot® Finish Mop	1"	6.0 lb	Medium	2.5 cm	2.7 kg	WHT	6
FGA41306	WH00	Web Foot® Finish Mop	1"	8.6 lb	Large	2.5 cm	3.9 kg	WHT	6

Swinger Loop® Shrinkless Wet Mops

Prelaudered and preshrunk for increased mop performance after laundering.

- Balanced 4-ply blend of cotton and synthetic yarn for absorbency and strength
- Looped-end, woven tailbanded mop provides greater floor coverage
- PVC-coated mesh headband for longer product life
- Recycled content: colors are up to 65% post-industrial cotton and 35% PET plastic
- Standard launderability, up to 50 launderings



No.	Mop Color	Description	U.S. Headband Size	U.S. Ship Wt/Ctn	Mop Size	Metric Headband Size	Metric Ship Wt/Ctn	Headband Color	Pack
FGC21106	GR00, WH00, BL00, OR00	Swinger Loop® Shrinkless Wet Mop	1"	5.8 lb	Small	2.5 cm	2.6 kg	YEL	6
FGC21206	GR00, WH00, BL00, OR00	Swinger Loop® Shrinkless Wet Mop	1"	7.6 lb	Medium	2.5 cm	3.4 kg	GRN	6
FGC21306	GR00, WH00, BL00, OR00	Swinger Loop® Shrinkless Wet Mop	1"	10.8 lb	Large	2.5 cm	4.9 kg	RED	6
FGC25106	GR00, WH00, BL00, OR00	Swinger Loop® Shrinkless Wet Mop	5"	5.9 lb	Small	12.7 cm	2.7 kg	YEL	6
FGC25206	GR00, WH00, BL00, OR00	Swinger Loop® Shrinkless Wet Mop	5"	7.7 lb	Medium	12.7 cm	3.5 kg	GRN	6
FGC25306	GR00, WH00, BL00, OR00	Swinger Loop® Shrinkless Wet Mop	5"	10.9 lb	Large	12.7 cm	4.9 kg	RED	6
FGC25406	GR00, WH00, BL00	Swinger Loop® Shrinkless Wet Mop	5"	13.1 lb	X-Large	12.7 cm	5.9 kg	BLUE	6

Swinger Loop® Wet Mops

Looped-end, tailbanded mop for better floor coverage.

- Balanced 4-ply blend of cotton and synthetic yarn for absorbency and strength
- Launderable for long product life
- Recycled content: colors are up to 65% post-industrial cotton and 35% PET plastic
- Shipped as compact mop packages
- Standard launderability, up to 50 launderings



No.	Mop Color	Description	U.S. Headband Size	U.S. Ship Wt/Ctn	Mop Size	Metric Headband Size	Metric Ship Wt/Ctn	Headband Color	Pack
FGC11106	GR00, WH00, BL00	Swinger Loop® Wet Mop	1"	4.5 lb	Small	2.5 cm	2 kg	YEL	6
FGC11206	GR00, WH00, BL00	Swinger Loop® Wet Mop	1"	6.0 lb	Medium	2.5 cm	2.7 kg	GRN	6
FGC11306	GR00, WH00, BL00	Swinger Loop® Wet Mop	1"	8.6 lb	Large	2.5 cm	3.9 kg	RED	6
FGC11406	GR00, WH00, BL00	Swinger Loop® Wet Mop	1"	10.9 lb	X-Large	2.5 cm	4.9 kg	BLUE	6
FGC15106	GR00, WH00, BL00	Swinger Loop® Wet Mop	5"	4.5 lb	Small	12.7 cm	2 kg	YEL	6
FGC15206	GR00, WH00, BL00	Swinger Loop® Wet Mop	5"	6.0 lb	Medium	12.7 cm	2.7 kg	GRN	6
FGC15306	GR00, WH00, BL00	Swinger Loop® Wet Mop	5"	8.6 lb	Large	12.7 cm	3.9 kg	RED	6
FGC15406	GR00, WH00, BL00	Swinger Loop® Wet Mop	5"	10.9 lb	X-Large	12.7 cm	4.9 kg	BLUE	6

Swinger Loop® Finish Mops

Tightly twisted 8-ply yarn inhibits linting and provides a smooth, even application of floor finish.

- Tapeless tailband helps reduce streaking
- Compact mop packaging makes mop storage and inventory management more efficient
- Recycled content: 74% PET plastic
- Shipped as compact mop packages
- Standard launderability, up to 50 launderings



No.	Mop Color	Description	U.S. Headband Size	U.S. Ship Wt/Ctn	Mop Size	Metric Headband Size	Metric Ship Wt/Ctn	Headband Color	Pack
FGC41206	WH00	Swinger Loop® Finish Mop	1"	6.0 lb	Medium	2.5 cm	2.7 kg	WHT	6
FGC41306	WH00	Swinger Loop® Finish Mop	1"	8.6 lb	Large	2.5 cm	3.9 kg	WHT	6

HANDLES FOR ALL OF THESE MOPS CAN BE FOUND ON PAGES 75–76.

WHEN ORDERING PRODUCTS WITH **BOLD** COLOR CODES, PLEASE SPECIFY COLOR CODE AFTER THE PRODUCT NUMBER. REFER TO THE PRODUCT COLOR GUIDE AT THE BACK OF THE CATALOG.

SEE WET MOP SELECTION GUIDE ON PAGE 64.

Super Stitch® Blend Mops

Outperforms and outlasts premium cut-end mops 2 to 1.

- Balanced blend of cotton and synthetic yarns for absorbency and strength
- Looped ends and yarn tailband provide greater floor coverage
- Recycled content: colors are up to 65% post-industrial cotton and 35% PET plastic
- **Shipped as compact mop packages**
- Limited launderability, or hand wash up to 50 launderings



No.	Mop Color	Description	U.S. Headband Size	U.S. Ship Wt/Ctn	Mop Size	Metric Headband Size	Metric Ship Wt/Ctn	Headband Color	Pack
FGD21106	GR00, WH00	Super Stitch® Blend Mop	1"	4.0 lb	Small	2.5 cm	1.8 kg	YEL	6
FGD21206	GR00*, RD00, WH00	Super Stitch® Blend Mop	1"	5.9 lb	Medium	2.5 cm	2.7 kg	GRN	6
FGD21306	GR00, RD00, WH00*, BLO0	Super Stitch® Blend Mop	1"	8.0 lb	Large	2.5 cm	3.6 kg	RED	6
FGD21406	WH00	Super Stitch® Blend Mop	1"	10.7 lb	X-Large	2.5 cm	4.9 kg	BLUE	6
FGD25106	GR00, WH00, BLO0	Super Stitch® Blend Mop	5"	4.0 lb	Small	12.7 cm	1.8 kg	YEL	6
FGD25206	GR00, RD00, WH00, BLO0	Super Stitch® Blend Mop	5"	5.9 lb	Medium	12.7 cm	2.7 kg	GRN	6
FGD25306	GR00, RD00, WH00, BLO0	Super Stitch® Blend Mop	5"	8.0 lb	Large	12.7 cm	3.6 kg	RED	6
FGD25406	WH00	Super Stitch® Blend Mop	5"	11.5 lb	X-Large	12.7 cm	5.2 kg	BLUE	6

*Available in Bolt-On Headband 12 pack.

Super Stitch® Rayon Mops

Economical floor finish applicator.

- Looped ends and yarn tailband help reduce streaking
- Tightly twisted, 4-ply yarn helps reduce linting
- **Shipped as compact mop packages**
- Recycled content: up to 75% PET Plastic
- Limited launderability, or hand wash up to 50 launderings



No.	Mop Color	Description	U.S. Headband Size	U.S. Ship Wt/Ctn	Mop Size	Metric Headband Size	Metric Ship Wt/Ctn	Headband Color	Pack
FGD41206	WH00	Super Stitch® Rayon Mop	1"	5.9 lb	Medium	2.5 cm	2.7 kg	GRN	6
FGD41306	WH00	Super Stitch® Ra-yon Mop	1"	8.0 lb	Large	2.5 cm	3.6 kg	RED	6
FGD45206	WH00	Super Stitch® Rayon Mop	5"	5.9 lb	Medium	12.7 cm	2.7 kg	GRN	6
FGD45306	WH00	Super Stitch® Rayon Mop	5"	8.0 lb	Large	12.7 cm	3.6 kg	RED	6

Super Stitch® Cotton Mop

Economical, general-purpose mop.

- Looped-end 4-ply yarn with yarn tailband for greater coverage with each stroke
- Recycled content: up to 100% post-industrial cotton
- **Shipped as compact mop packages**
- Limited launderability, or hand wash up to 50 launderings



No.	Mop Color	Description	U.S. Headband Size	U.S. Ship Wt/Ctn	Mop Size	Metric Headband Size	Metric Ship Wt/Ctn	Headband Color	Pack
FGD11306	WH00	Super Stitch® Cotton Looped-End Wet Mop	1"	7.6 lb	Large	2.5 cm	3.4 kg	RED	6

Super Stitch® Finish Mops

Blend yarns for great absorbency and release.

- Bright blue and white yarn helps identify finish mop versus general-purpose mop
- Looped ends and yarn tailband help reduce streaking
- Tightly twisted, 4-ply polyester and rayon yarn helps reduce linting
- Recycled content: 74% PET plastic
- **Shipped as compact mop packages**
- Limited launderability, or hand wash up to 50 launderings



No.	Mop Color	Description	U.S. Headband Size	U.S. Ship Wt/Ctn	Mop Size	Metric Headband Size	Metric Ship Wt/Ctn	Headband Color	Pack
FGD51206	WH00	Super Stitch® Finish Mop	1"	5.9 lb	Medium	2.5 cm	2.7 kg	BLUE	6
FGD51306	WH00	Super Stitch® Finish Mop	1"	5.9 lb	Large	2.5 cm	2.7 kg	BLUE	6
FGD55206	WH00	Super Stitch® Finish Mop	5"	8.0 lb	Medium	12.7 cm	3.6 kg	BLUE	6
FGD55306	WH00	Super Stitch® Finish Mop	5"	8.0 lb	Large	12.7 cm	3.6 kg	BLUE	6

Universal Headband Blue Blend Mops

Cotton/synthetic yarn blend has almost twice the absorbency of cotton.

- Looped ends reduce fraying associated with cut-end mops
- Universal headband fits both side-loading and clamp-style handles
- Recycled content: up to 65% post-industrial cotton and 35% PET plastic
- Limited launderability, or hand wash up to 50 launderings



No.	Mop Color	Description	U.S. Headband Size	Mop Size	U.S. Ship Wt/Ctn	Metric Headband Size	Metric Ship Wt/Ctn	Headband Color	Pack
FGE23600	BL00	Universal Headband Blue Blend Mop	Universal	16 oz	13.0 lb	0.5 kg	5.9 kg	BLUE	12
FGE23800	BL00	Universal Headband Blue Blend Mop	Universal	24 oz	19.0 lb	0.7 kg	8.6 kg	BLUE	12
FGE23900	BL00	Universal Headband Blue Blend Mop	Universal	32 oz	25.0 lb	0.9 kg	11.3 kg	BLUE	12

Universal Headband Rayon Mops

Ideal for floor finish application.

- Looped ends reduce linting and depling
- Universal headband fits both side-loading and clamp-style handles
- Recycled content: up to 75%
- Limited launderability, or hand wash up to 50 launderings



No.	Mop Color	Description	U.S. Headband Size	Mop Size	U.S. Ship Wt/Ctn	Metric Headband Size	Metric Ship Wt/Ctn	Headband Color	Pack
FGE43600	WH00	Universal Headband Rayon Mop	Universal	16 oz	13.0 lb	0.5 kg	5.9 kg	BLUE	12
FGE43800	WH00	Universal Headband Rayon Mop	Universal	24 oz	19.0 lb	0.7 kg	8.6 kg	BLUE	12
FGE43900	WH00	Universal Headband Rayon Mop	Universal	32 oz	25.0 lb	0.9 kg	11.3 kg	BLUE	12

Universal Headband Cotton Mops

Excellent, all-purpose mop for general cleaning.

- Looped ends reduce fraying associated with cut-end mops
- Universal headband fits both side-loading and clamp-style handles
- Recycled content: up to 100% post-industrial cotton
- Limited launderability, or hand wash up to 50 launderings



No.	Mop Color	Description	U.S. Headband Size	Mop Size	U.S. Ship Wt/Ctn	Metric Headband Size	Metric Ship Wt/Ctn	Headband Color	Pack
FGE13600	WH00	Universal Headband Cotton Mop	Universal	16 oz	12.0 lb	0.5 kg	5.4 kg	BLUE	12
FGE13800	WH00	Universal Headband Cotton Mop	Universal	24 oz	18.0 lb	0.7 kg	8.2 kg	BLUE	12
FGE13900	WH00	Universal Headband Cotton Mop	Universal	32 oz	24.0 lb	0.9 kg	10.9 kg	BLUE	12

HANDLES FOR ALL OF THESE MOPS CAN BE FOUND ON PAGES 75–76.

WHEN ORDERING PRODUCTS WITH **BOLD** COLOR CODES,
PLEASE SPECIFY COLOR CODE AFTER THE PRODUCT NUMBER.
REFER TO THE PRODUCT COLOR GUIDE AT THE BACK OF THE CATALOG.

SEE WET MOP SELECTION
GUIDE ON PAGE 64.

Cut-End Blend Mops

Cut-end, 4-ply cotton/rayon/synthetic yarn blend for good performance and durability.

- Outlasts and outperforms cotton
- Excellent absorbency
- Narrow and wide headbands available
- Recycled content: colors are up to 65% post-industrial cotton and 35% PET plastic
- Nonlaunderable, bucket wash/wring only



No.	Mop Color	Description	U.S. Headband Size	U.S. Mop Size	U.S. Ship Wt/Ctn	Metric Headband Size	Metric Mop Size	Metric Ship Wt/Ctn	Headband Color	Pack
FGF51600	WH00, BLOO	Premium Cut-End Blend Mop	1"	16 oz	13.0 lb	2.5 cm	0.5 kg	5.9 kg	ORAN	12
FGF51700	WH00, BLOO	Premium Cut-End Blend Mop	1"	20 oz	16.0 lb	2.5 cm	0.6 kg	7.3 kg	ORAN	12
FGF51800	WH00, BLOO	Premium Cut-End Blend Mop	1"	24 oz	19.0 lb	2.5 cm	0.7 kg	8.6 kg	ORAN	12
FGF51900	WH00, BLOO	Premium Cut-End Blend Mop	1"	32 oz	25.0 lb	2.5 cm	0.9 kg	11.3 kg	ORAN	12
FGF55600	WH00, BLOO	Premium Cut-End Blend Mop	5"	16 oz	13.0 lb	12.7 cm	0.5 kg	5.9 kg	BLUE	12
FGF55700	WH00, BLOO	Premium Cut-End Blend Mop	5"	20 oz	16.0 lb	12.7 cm	0.6 kg	7.3 kg	BLUE	12
FGF55800	WH00, BLOO	Premium Cut-End Blend Mop	5"	24 oz	19.0 lb	12.7 cm	0.7 kg	8.6 kg	BLUE	12
FGF55900	WH00, BLOO	Premium Cut-End Blend Mop	5"	32 oz	25.0 lb	12.7 cm	0.9 kg	11.3 kg	BLUE	12

Cut-End Rayon Mops

Economical, 4-ply cut-end mop for floor finish applications.

- Excellent absorbency and release characteristics
- For economical floor finish applications
- Recycled content: up to 75%
- Nonlaunderable, bucket wash/wring only



No.	Mop Color	Description	U.S. Headband Size	U.S. Mop Size	U.S. Ship Wt/Ctn	Metric Headband Size	Metric Mop Size	Metric Ship Wt/Ctn	Headband Color	Pack
FGF41600	WH00	Premium Cut-End Rayon Mop	1"	16 oz	13.0 lb	2.5 cm	0.5 kg	5.9 kg	ORAN	12
FGF41700	WH00	Premium Cut-End Rayon Mop	1"	20 oz	16.0 lb	2.5 cm	0.6 kg	7.3 kg	ORAN	12
FGF41800	WH00	Premium Cut-End Rayon Mop	1"	24 oz	19.0 lb	2.5 cm	0.7 kg	8.6 kg	ORAN	12

Cut-End Cotton Mops

Economical, 4-ply cut-end mop for general-purpose cleaning.

- Absorbent 4-ply cotton for general-purpose mopping
- Narrow and wide headbands available (1" and 5")
- Recycled content: up to 100% post-industrial cotton
- Shipped as compact mop packages
- Nonlaunderable, bucket wash/wring only



No.	Mop Color	Description	U.S. Headband Size	U.S. Mop Size	U.S. Ship Wt/Ctn	Metric Headband Size	Metric Mop Size	Metric Ship Wt/Ctn	Headband Color	Pack
FGF11600	WH00	Premium Cut-End Cotton Mop	1"	16 oz	12.0 lb	2.5 cm	0.5 kg	5.4 kg	ORAN	12
FGF11700	WH00	Premium Cut-End Cotton Mop	1"	20 oz	15.0 lb	2.5 cm	0.6 kg	6.8 kg	ORAN	12
FGF11800	WH00	Premium Cut-End Cotton Mop	1"	24 oz	18.0 lb	2.5 cm	0.7 kg	8.2 kg	ORAN	12
FGF11900	WH00	Premium Cut-End Cotton Mop	1"	32 oz	24.0 lb	2.5 cm	0.9 kg	10.9 kg	ORAN	12
FGF15600	WH00	Premium Cut-End Cotton Mop	5"	16 oz	12.0 lb	12.7 cm	0.5 kg	5.4 kg	BLUE	12
FGF15700	WH00	Premium Cut-End Cotton Mop	5"	20 oz	15.0 lb	12.7 cm	0.6 kg	6.8 kg	BLUE	12
FGF15800	WH00	Premium Cut-End Cotton Mop	5"	24 oz	18.0 lb	12.7 cm	0.7 kg	8.2 kg	BLUE	12
FGF15900	WH00	Premium Cut-End Cotton Mop	5"	32 oz	24.0 lb	12.7 cm	0.9 kg	10.9 kg	BLUE	12

Bolt-On Cut-End Blend Mops

Cut-end mop with screw-on head for general-purpose mopping.

- Blend of 4-ply cotton/rayon/synthetic
- Enhanced mop-to-floor contact
- Use with FGH31600 Bolt-On Wet Mop Handle
- Recycled content: colors are up to 65% post-industrial cotton and 35% PET plastic
- Nonlaunderable, bucket wash/wring only



No.	Mop Color	Description	U.S. Mop Size	U.S. Ship Wt/Ctn	Metric Mop Size	Metric Ship Wt/Ctn	Pack
FGF56600	WH00, BL00	Premium Bolt-On Cut-End Blend Mop	16 oz	13.0 lb	0.5 kg	5.9 kg	12
FGF56700	BL00	Premium Bolt-On Cut-End Blend Mop	20 oz	16.0 lb	0.6 kg	7.3 kg	12
FGF56800	WH00, BL00	Premium Bolt-On Cut-End Blend Mop	24 oz	19.0 lb	0.7 kg	8.6 kg	12
FGF56900	BL00	Premium Bolt-On Cut-End Blend Mop	32 oz	25.0 lb	0.9 kg	11.3 kg	12

Bolt-On Cut-End Rayon Mops

Cut-end mop for finish application.

- Cut-end, 4-ply rayon yarn
- Enhanced mop-to-floor contact
- Recycled content: up to 75%
- Use with FGH31600 Bolt-On Wet Mop Handle
- Nonlaunderable, bucket wash/wring only



No.	Mop Color	Description	U.S. Mop Size	U.S. Ship Wt/Ctn	Metric Mop Size	Metric Ship Wt/Ctn	Pack
FGF46700	WH00	Premium Bolt-On Cut-End Rayon Mop	20 oz	16.0 lb	0.6 kg	7.3 kg	12
FGF46800	WH00	Premium Bolt-On Cut-End Rayon Mop	24 oz	19.0 lb	0.7 kg	8.6 kg	12

Bolt-On Cut-End Cotton Mops

Cut-end mop with screw-on head for general-purpose mopping.

- Absorbent 4-ply cotton yarn
- Enhanced mop-to-floor contact
- Use with FGH31600 Bolt-On Wet Mop Handle
- Recycled content: up to 100% post-industrial cotton
- Nonlaunderable, bucket wash/wring only



No.	Mop Color	Description	U.S. Mop Size	U.S. Ship Wt/Ctn	Metric Mop Size	Metric Ship Wt/Ctn	Pack
FGF16600	WH00	Premium Bolt-On Cut-End Cotton Mop	16 oz	13.0 lb	0.5 kg	5.9 kg	12
FGF16700	WH00	Premium Bolt-On Cut-End Cotton Mop	20 oz	16.0 lb	0.6 kg	7.3 kg	12
FGF16800	WH00	Premium Bolt-On Cut-End Cotton Mop	24 oz	19.0 lb	0.7 kg	8.6 kg	12
FGF16900	WH00	Premium Bolt-On Cut-End Cotton Mop	32 oz	25.0 lb	0.9 kg	11.3 kg	12

8-Ply Cut-End Cotton Mops

Economical, 8-ply cut-end mop for general-purpose cleaning.

- Abrasion-resistant, long-lasting 8-ply cotton
- Recycled content: up to 100% post-industrial cotton
- Nonlaunderable, bucket wash/wring



No.	Mop Color	Description	U.S. Headband Size	U.S. Mop Size	U.S. Ship Wt/Ctn	Metric Headband Size	Metric Mop Size	Metric Ship Wt/Ctn	Headband Color	Pack
FGF21600	WH00	Premium 8-Ply Cut-End Cotton Mop	1"	16 oz	13.0 lb	2.5 cm	0.5 kg	5.9 kg	ORAN	12
FGF21700	WH00	Premium 8-Ply Cut-End Cotton Mop	1"	20 oz	16.0 lb	2.5 cm	0.6 kg	7.3 kg	ORAN	12
FGF21800	WH00	Premium 8-Ply Cut-End Cotton Mop	1"	24 oz	19.0 lb	2.5 cm	0.7 kg	8.6 kg	ORAN	12
FGF21900	WH00	Premium 8-Ply Cut-End Cotton Mop	1"	32 oz	25.0 lb	2.5 cm	0.9 kg	11.3 kg	ORAN	12

HANDLES FOR ALL OF THESE MOPS CAN BE FOUND ON PAGES 75–76.

WHEN ORDERING PRODUCTS WITH **BOLD** COLOR CODES, PLEASE SPECIFY COLOR CODE AFTER THE PRODUCT NUMBER. REFER TO THE PRODUCT COLOR GUIDE AT THE BACK OF THE CATALOG.

SEE WET MOP SELECTION GUIDE ON PAGE 64.

Synthetic Blend Mops

Economical, cut-end wet mop for general cleaning.

- All-synthetic mop yarn resists abrasive floor surfaces, such as quarry tile, for long-lasting performance
- Yarn blend absorbs 4 to 5 times the mop's weight
- Colors are perfect for a color-coding system and resist mop graying for long-lasting, like-new appearance
- Available in compact packages
- Recycled content: up to 70% post-consumer PET plastic
- Nonlaunderable, bucket wash/wring only



No.	Mop Color	Description	U.S. Headband Size	U.S. Mop Size	U.S. Ship Wt/Ctn	Metric Headband Size	Metric Mop Size	Metric Ship Wt/Ctn	Headband Color	Pack
FGF13100	PINK, GR00, BL00	Synthetic Blend Mop	1"	16 oz	6.0 lb	2.5 cm	0.5 kg	2.7 kg	WHT	6
FGF13200	PINK, GR00, BL00	Synthetic Blend Mop	1"	24 oz	8.6 lb	2.5 cm	0.7 kg	3.9 kg	WHT	6
FGF13600	PINK, GR00, BL00	Synthetic Blend Mop	5"	16 oz	6.0 lb	12.7 cm	0.5 kg	2.7 kg	WHT	6
FGF13700	PINK, GR00, BL00	Synthetic Blend Mop	5"	24 oz	8.6 lb	12.7 cm	0.7 kg	3.9 kg	WHT	6

Clean Room Maintenance Mops

Looped-end, tailbanded mop for greater floor coverage with each stroke.

- For use in Class 10,000 and higher industrial applications, such as paint booths and pharmaceutical labs
- Made of woven, rayon/polyester fabric that will not fray or lint
- Launderable and preshrunk for long product life
- Premium launderability, up to 75 launderings



No.	Mop Color	Description	U.S. Headband Size	U.S. Mop Size	U.S. Ship Wt/Ctn	Metric Headband Size	Metric Mop Size	Metric Ship Wt/Ctn	Headband Color	Pack
FGT30000	WH00	Clean Room Mop	5"	16 oz	13.0 lb	12.7 cm	0.5 kg	5.9 kg	GRN	12
FGT30100	WH00	Clean Room Mop	5"	24 oz	19.0 lb	12.7 cm	0.7 kg	8.6 kg	RED	12

Rough Floor Wet Mop

Economical choice for abrasive floor surfaces.

- Knitted fleece cotton/polyester blend yarn has twice the absorbency of cotton
- Excels on abrasive floor surfaces, such as nonslip/nonskid, stone, terrazzo, concrete, and other textured floor surfaces
- Looped ends and tailband aid in launderability
- Headband is compatible with Clamp-Style Wet Mop Handle
- Premium launderability, up to 75 launderings



No.	Mop Color	Description	Mop Size	U.S. Headband Size	U.S. Ship Wt/Ctn	Metric Headband Size	Metric Ship Wt/Ctn	Headband Color	Pack
FGT25500	WH00	Rough Floor Wet Mop	Medium	5"	12.0 lb	12.7 cm	5.4 kg	GRN	12
FGT25600	WH00	Rough Floor Wet Mop	Large	5"	15.0 lb	12.7 cm	6.8 kg	RED	12

ENVIRONMENTALLY FRIENDLY PACKAGING

Compact packaging uses less plastic and reduces waste. Available in these SKUs:

FGA11106	FGC11206	FGD11306	FGD41206	FGF11700	FGV11800	FGV41900
FGA11206	FGC11306	FGD21106	FGD41306	FGF11800	FGV11900	FGV46900
FGA11306	FGC11406	FGD21206	FGD45206	FGF11900	FGV15600	
FGA15106	FGC15106	FGD21306	FGD45306	FGF15600	FGV15700	
FGA15206	FGC15206	FGD21406	FGD51206	FGF15700	FGV15800	
FGA15306	FGC15306	FGD25106	FGD51306	FGF15800	FGV15900	
FGA41206	FGC15406	FGD25206	FGD55206	FGF15900	FGV41600	
FGA41306	FGC41206	FGD25306	FGD55306	FGV11600	FGV41700	
FGC11106	FGC41306	FGD25406	FGF11600	FGV11700	FGV41800	



Economy Cotton and Rayon Cut-End Wet Mops

- Cotton mop for general, all-purpose cleaning; rayon mop for finish application
- Available in narrow and wide headbands (1" and 5")
- Recycled content: up to 100% post-industrial cotton
- Shipped as compact mop packages
- Nonlaunderable, bucket wash/wring only



ECONOMY COTTON MOPS

No.	Mop Color	Description	U.S. Headband Size	U.S. Ship Wt/Ctn	Mop Size	Metric Headband Size	Metric Ship Wt/Ctn	Headband Color	Pack
FGV11600	WH00	Economy Cotton Cut-End Mop	1"	10.1 lb	#16	2.5 cm	4.6 kg	WHT	12
FGV11700	WH00	Economy Cotton Cut-End Mop	1"	13.1 lb	#20	2.5 cm	5.9 kg	WHT	12
FGV11800	WH00	Economy Cotton Cut-End Mop	1"	15.8 lb	#24	2.5 cm	7.2 kg	WHT	12
FGV11900	WH00	Economy Cotton Cut-End Mop	1"	21.0 lb	#32	2.5 cm	9.5 kg	WHT	12
FGV15600	WH00	Economy Cotton Cut-End Mop	5"	10.2 lb	#16	12.7 cm	4.6 kg	WHT	12
FGV15700	WH00	Economy Cotton Cut-End Mop	5"	13.1 lb	#20	12.7 cm	5.9 kg	WHT	12
FGV15800	WH00	Economy Cotton Cut-End Mop	5"	15.8 lb	#24	12.7 cm	7.2 kg	WHT	12
FGV15900	WH00	Economy Cotton Cut-End Mop	5"	21.0 lb	#32	12.7 cm	9.5 kg	WHT	12

ECONOMY RAYON MOPS

No.	Mop Color	Description	U.S. Headband Size	U.S. Ship Wt/Ctn	Mop Size	Metric Headband Size	Metric Ship Wt/Ctn	Headband Color	Pack
FGV41600	WH00	Economy Rayon Cut-End Mop	1"	12.0 lb	#16	2.5 cm	5.4 kg	WHT	12
FGV41700	WH00	Economy Rayon Cut-End Mop	1"	15.0 lb	#20	2.5 cm	6.8 kg	WHT	12
FGV41800	WH00	Economy Rayon Cut-End Mop	1"	18.0 lb	#24	2.5 cm	8.2 kg	WHT	12
FGV41900	WH00	Economy Rayon Cut-End Mop	1"	23.0 lb	#32	2.5 cm	10.4 kg	WHT	12

ECONOMY BOLT-ON RAYON MOPS

No.	Mop Color	Description	U.S. Ship Wt/Ctn	Mop Size	Metric Ship Wt/Ctn	Pack
FGV46900	WH00	Economy Bolt-On Rayon Cut-End Mop	21.0 lb	#32	9.5 kg	12

Nylon Finish Mops

Nonlinting, continuous-filament yarn leaves an even, glossy, long-lasting finish every time.

- Innovative looped-end yarn construction holds finish for an even, efficient release
- Mop glides effortlessly across floor surface
- Premium launderability, up to 75 launderings



No.	Color	Description	U.S. Headband Size	U.S. Mop Size	U.S. Ship Wt/Ctn	Metric Headband Size	Metric Mop Size	Metric Ship Wt/Ctn	Pack
FGT20006	WH00	Nylon Finish Mop	1"	Medium	7.1 lb	2.5 cm	Medium	3.2 kg	6
FGT20106	WH00	Nylon Finish Mop	1"	Large	9.9 lb	2.5 cm	Large	4.5 kg	6

HANDLES FOR ALL OF THESE MOPS CAN BE FOUND ON PAGES 75–76.

WHEN ORDERING PRODUCTS WITH **BOLD** COLOR CODES,
PLEASE SPECIFY COLOR CODE AFTER THE PRODUCT NUMBER.
REFER TO THE PRODUCT COLOR GUIDE AT THE BACK OF THE CATALOG.

SEE WET MOP SELECTION
GUIDE ON PAGE 64.

Wet Mop Handles

Invader® and Gripper® Wet Mop Handles make removing and replacing mop heads easy and efficient.

- Invader® Side-Gate Handle's thumb wheel clamps the mop firmly in place; should be used with 1" headband mops
- Gripper® Clamp-Style Handles hold mop firmly between the jaws of the mop handle; should be used with 5" headband mops only
- Hardwood, Aluminum and Fiberglass for all applications

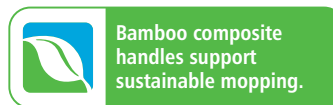

FGH11700



INVADER® SIDE-GATE HANDLES



New!



No.	Color	Description	U.S. Dimensions	U.S. Ship Wt/Ctn	Metric Dimensions	Metric Ship Wt/Ctn	Pack
FGH11500	0000	Invader® Side-Gate Wet Mop Handle, Large Yellow Plastic Head, Hardwood Handle	54" l	13.0 lb	137.2 cm	5.9 kg	12
FGH11600	0000	Invader® Side-Gate Wet Mop Handle, Large Yellow Plastic Head, Hardwood Handle	60" l	15.0 lb	152.4 cm	6.8 kg	12
FGH11700	0000	Invader® Side-Gate Wet Mop Handle, Large Black Plastic Head, Bamboo Composite Handle	60" l	18.4 lb	152.4 cm	8.4 kg	12
1863902	BLACK	Executive Series™ Invader® Side-Gate Wet Mop Handle, Large Black Plastic Head, Bamboo Composite Handle	60" l	18.4 lb	152.4 cm	8.4 kg	12
FGH12500	0000	Invader® Side-Gate Wet Mop Handle, Large Yellow Plastic Head, Gray Aluminum Handle	54" l	11.0 lb	137.2 cm	5 kg	12
FGH12600	0000	Invader® Side-Gate Wet Mop Handle, Large Yellow Plastic Head, Gray Aluminum Handle	60" l	12.0 lb	152.4 cm	5.4 kg	12
FGH13500	0000	Invader® Side-Gate Wet Mop Handle, Large Yellow Plastic Head, Vinyl-Covered Aluminum Handle	54" l	15.0 lb	137.2 cm	6.8 kg	12
FGH13600	0000	Invader® Side-Gate Wet Mop Handle, Large Yellow Plastic Head, Vinyl-Covered Aluminum Handle	60" l	17.0 lb	152.4 cm	7.7 kg	12
FGH14500	0000	Invader® Side-Gate Wet Mop Handle, Large Yellow Plastic Head, Fiberglass Handle	54" l	15.0 lb	137.2 cm	6.8 kg	12
FGH14600	GY00, GR00, RD00, BL00	Invader® Side-Gate Wet Mop Handle, Large Yellow Plastic Head, Fiberglass Handle	60" l	17.0 lb	152.4 cm	7.7 kg	12
1863903	BLACK	Executive Series™ Invader® Side-Gate Wet Mop Handle, Large Black Plastic Head, Fiberglass Handle	60" l	17.0 lb	152.4 cm	7.7 kg	12
FGH41600	0000	Stirrup-Style Wet Mop Handle, Large Yellow Steel Head, Wood Handle	60" l x 1 1/4" dia	31.0 lb	2.9 cm dia x 152.4 cm	14.1 kg	12
FGH51600	0000	Easy-Change Wet Mop Handle, Large Steel Head, Wood Handle	60" l x 1 1/4" dia	31.0 lb	2.9 cm dia x 152.4 cm	14.1 kg	12

New!



FGH21700



GRIPPER® CLAMP-STYLE HANDLES



GRIPPER® CLAMP-STYLE HANDLES

New!



No.	Color	Description	U.S. Dimensions	U.S. Ship Wt/Ctn	Metric Dimensions	Metric Ship Wt/Ctn	Pack
FGH21500	0000	Gripper® Clamp-Style Wet Mop Handle, Plastic Yellow Head, Hardwood Handle	54" l	13.0 lb	137.2 cm	5.9 kg	12
FGH21600	0000	Gripper® Clamp-Style Wet Mop Handle, Plastic Yellow Head, Hardwood Handle	60" l	15.0 lb	152.4 cm	6.8 kg	12
FGH21700	0000	Gripper® Clamp-Style Wet Mop Handle, Plastic Black Head, Bamboo Composite Handle	60" l	16.9 lb	152.4 cm	7.7 kg	12
1863901	BLACK	Executive Series™ Gripper® Clamp-Style Wet Mop Handle, Plastic Black Head, Bamboo Composite Handle	60" l	16.9 lb	152.4 cm	7.7 kg	12
FGH22500	0000	Gripper® Clamp-Style Wet Mop Handle, Plastic Yellow Head, Gray Aluminum Handle	54" l	11.0 lb	137.2 cm	5 kg	12
FGH22600	0000	Gripper® Clamp-Style Wet Mop Handle, Plastic Yellow Head, Gray Aluminum Handle	60" l	12.0 lb	152.4 cm	5.4 kg	12
FGH23500	0000	Gripper® Clamp-Style Wet Mop Handle, Plastic Yellow Head, Vinyl-Coated Aluminum Handle	54" l	15.0 lb	137.2 cm	6.8 kg	12
FGH23600	0000	Gripper® Clamp-Style Wet Mop Handle, Plastic Yellow Head, Vinyl-Coated Aluminum Handle	60" l	17.0 lb	152.4 cm	7.7 kg	12
FGH24500	0000	Gripper® Clamp-Style Wet Mop Handle, Plastic Yellow Head, Fiberglass Handle	54" l	15.0 lb	137.2 cm	6.8 kg	12
FGH24600	GY00, GR00, RD00, BL00	Gripper® Clamp-Style Wet Mop Handle, Plastic Yellow Head, Fiberglass Handle	60" l	17.0 lb	152.4 cm	7.7 kg	12

Adjustable Mop Handle

Designed to help reduce the physical strain of mopping.

- Unique handle grip swivels radially a full 360° in either direction to help reduce wrist strain
- Corrosion-resistant aluminum handle adjusts from 54" to 66" for maximum reach
- User-friendly bent handle minimizes the force and leverage required for smooth mopping
- Available with a Clamp-Style Head that accommodates a 5" headband mop or the Side-Gate Head that accommodates a 1" headband mop



FGH12400



No.	Color	Description	U.S. Dimensions	U.S. Ship Wt/Ctn	Metric Dimensions	Metric Ship Wt/Ctn	Pack
FGH12400	0000	User-Friendly Mop Handle with Side-Gate Head	54"-66" l	11.0 lb	137.2 cm – 167.6 cm	5 kg	12
FGH22400	0000	User-Friendly Mop Handle with Clamp-Style Head	54"-66" l	11.0 lb	137.2 cm – 167.6 cm	5 kg	12

Bolt-On Wet Mop Handle

Combines durable metal head with a quality hardwood handle.

- Threaded-bolt head for quick and easy mop changes
- Helps provide more contact with the floor surface

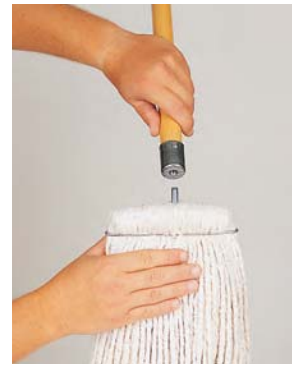

FGH31600

No.	Color	Description	U.S. Dimensions	U.S. Ship Wt/Ctn	Metric Dimensions	Metric Ship Wt/Ctn	Pack
FGH31600	0000	Bolt-On Wet Mop Handle, Metal Cap, Wood Handle	60" l	20.0 lb	152.4 cm	9.1 kg	12

Laundry Net

Helps protect mops, microfiber pads, and other cleaning items during laundering.

- Locking closure keeps pads and cloths secure
- Provides easy organization for multiple cleaning crews



FGU21000

No.	Color	Description	U.S. Size	U.S. Ship Wt/Ctn	Metric Size	Metric Ship Wt/Ctn	Pack
FGU21000	WH00	Laundry Net, Synthetic Mesh Bag with Locking Closure	36" l x 24" w	6.0 lb	91.4 cm x 61 cm	2.7 kg	12

WHEN ORDERING PRODUCTS WITH **BOLD** COLOR CODES, PLEASE SPECIFY COLOR CODE AFTER THE PRODUCT NUMBER. REFER TO THE PRODUCT COLOR GUIDE AT THE BACK OF THE CATALOG.



Check out the items marked with this symbol for our new line of Executive Series™ products.

BRUTE® Buckets

Heavy-duty thick-walled construction.

- BRUTE® buckets have molded-in graduations for accurate measuring
- Corrosive-resistant bails with comfortable plastic grip



No.	Color	Description	U.S. Dimensions	U.S. Capacity	U.S. Ship Wt/Ctn	Metric Dimensions	Metric Capacity	Metric Ship Wt/Ctn	Pack
FG261400	RED, GRAY	Round Bucket	12" dia x 11.25" h	14 qt	10.7 lb	30.5 cm dia x 28.6 cm	13.2 L	4.9 kg	6
FG296300	RED, GRAY	Round Bucket	10.5" dia x 10.25" h	10 qt	14.3 lb	26.7 cm dia x 26 cm	9.5 L	6.5 kg	12
1834781	RED	Round Bucket – Sanitizer	10.5" dia x 10.25" h	10 qt	14.3 lb	26.7 cm dia x 26 cm	9.5 L	6.5 kg	12

Pail and Mop Strainer Combination

Lightweight design helps increase operator productivity.

- Lightweight combo pack lets operator travel up and down stairs easily
- Pail holds up to 15 quarts (14.2 L); strainer wrings mops up to 10 ounces
- Durable plastic construction has smooth, easy-to-clean surface
- Pails and funnel-shaped mop strainers nest and stack for convenient transport and storage between jobs



No.	Color	Description	U.S. Dimensions	U.S. Capacity	U.S. Ship Wt/Ctn	Metric Dimensions	Metric Capacity	Metric Ship Wt/Ctn	Pack
FG619400	STL	Pail and Mop Strainer Combination	17" l x 10.5" w x 12" h	15 qt	14.9 lb	43.2 cm x 26.7 cm x 30.5 cm	14.2 L	6.8 kg	6
FGG04204	WH00	Cotton Mop and Handle Combination	46" l	8 oz	5.0 lb	116.8 cm	0.2 kg	2.3 kg	4
FGG04300	WH00	Replacement Mop Head for FGG04204	N/A	8 oz	7.0 lb	N/A	0.2 kg	3.2 kg	12
1809375	N/A	Self-Wringing Twist Mop	54" l x 54" w	N/A	17.5 lb	137.2 cm x 137.2 cm	N/A	7.9 kg	4

Upright Scrubber Pad Holder

Ideal for general scrubbing, cleaning, and/or stripping of hard surfaces.

- Designed for spot floor cleaning and edge stripping jobs, even in hard-to-reach corners
- Securely holds commonly used 4" x 10" scrubbing pads
- FGQ31400 fits standard threaded handles



No.	Color	Description	U.S. Ship Wt/Ctn	Accepted Handles	Metric Ship Wt/Ctn	Pack
FGQ31100	GRAY	Upright Scrubber Pad Holder with Universal Locking Collar	2.2 lb	FG635100, FG636100	1 kg	6
FGQ31400	GY00	Upright Scrubber Pad Holder with Threaded Adapter	2.2 lb	FG635100, FG636100	1 kg	6

Steel Sponge Mop/Double Pails

An easy-to-use cleaning system.

- Front-pull lever on mop handle for squeeze-action wringing (FG643500)
- Cellulose sponge mop head absorbs liquids fast
- Double pail for separation of cleaning solution and rinse water



No.	Color	Description	U.S. Dimensions	U.S. Capacity	U.S. Ship Wt/Ctn	Metric Dimensions	Metric Capacity	Metric Ship Wt/Ctn	Pack
FG261700	GRAY	Double Pail	14.63" l x 13.88" w x 10.13" h	17 qt	18.1 lb	37.2 cm x 35.3 cm x 25.7 cm	16.1 L	8.2 kg	6
FG262888	GRAY	Double Pail	18" l x 14.5" w x 10" h	19 qt	21.1 lb	45.7 cm x 36.8 cm x 25.4 cm	18 L	9.6 kg	6
FG643500	BRNZ	Steel Sponge Mop with Cellulose Head	12" l	N/A	14.9 lb	30.5 cm	N/A	6.8 kg	6
FG643600	YEL	Steel Cellulose Replacement Head	12" l	N/A	8.4 lb	30.5 cm	N/A	3.8 kg	12
FGG78004		PVA Sponge Mop	11.3" l x 2.8" w x 37.6" h	N/A	35.0 lb	28.7 cm x 7.1 cm x 95.5 cm	N/A	15.9 kg	4
FGG78112		PVA Sponge Mop Refill	12.8" l x 4.2" w x 2.2" h	N/A	5.2 lb	32.5 cm x 10.7 cm x 5.6 cm	N/A	2.4 kg	12



Dust Mopping

There are several important factors to consider when choosing a dust mop. Use the guidelines on the following pages to choose the best dust mop for your floor care needs.

General Dust Mopping

Choose mops with high-dust pickup and durability. If laundering is available, launderable mops will be the most economical choice. Microfiber looped-end and twisted-loop mop heads with reinforced stitching and slip-on/slide-off backing offer the best performance and launderability.

Mop Construction Features

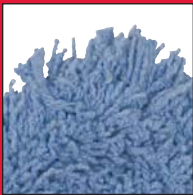

TWISTED LOOPS
Highly effective at capturing dust and dirt. Premium twisted loops are less prone to snags, frays, and unraveling during cleaning and laundering.



LOOPED ENDS
Reduce fraying and depling for better durability and longer product life. More effective than cut-end mops.



CUT ENDS
Economical construction for general purpose dusting.

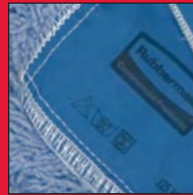

REINFORCED STITCHING
Reinforced, double-needle stitching at key "wear" points increases product life.



BACKING DESIGN
Slip-on/slide-off backing allows quick, easy setup for standard or breakdown mop frames.

Launderability

The launderability of a mop is based on the number of commercial washing and drying cycles it can withstand before the construction of the mop is degraded or the performance declines. Microfiber, synthetic, and blended fiber mops have the highest levels of launderability.

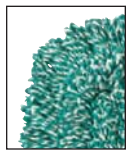

MICROFIBER



BLEND



SYNTHETIC

Durability

The durability of a mop is a measure of how long it will perform before needing to be replaced. Microfiber, synthetic, and blended fiber mops are the most durable.

Mops with **antimicrobial fibers** have greater durability because they inhibit the bacterial growth that causes mop odor and discoloration.

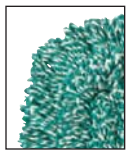

MICROFIBER



BLEND



ANTIMICROBIAL



SYNTHETIC

Dust Pickup

Dust pickup is the ability of a mop to remove dust and dirt from the floor surface. Microfiber, blended fiber, and synthetic mops have the highest degree of dust pickup.



MICROFIBER



SYNTHETIC



BLEND

WHEN ORDERING PRODUCTS WITH **BOLD** COLOR CODES, PLEASE SPECIFY COLOR CODE AFTER THE PRODUCT NUMBER. REFER TO THE PRODUCT COLOR GUIDE AT THE BACK OF THE CATALOG.



Check out the items marked with this symbol for our new line of Executive Series™ products.

Dust Mop Selection Guide

Use the following guide to choose the best Rubbermaid Commercial Products' Dust Mops for your facility.

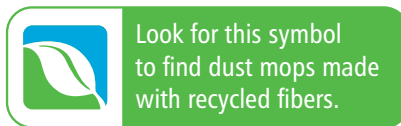

ENVIRONMENT	BEST	BETTER	GOOD
HEALTHCARE FACILITIES	Rubbermaid HYGEN™ Microfiber Dust Mops, Microfiber Looped-End Dust Mop, Twisted Loop Antimicrobial	Trapper®	Kut-A-Way®
EDUCATIONAL FACILITIES	Rubbermaid HYGEN™ Microfiber Dust Mops, Microfiber Looped-End Dust Mop, Twisted Loop	Kut-A-Way®	Cut-to-Length
INDUSTRIAL AND COMMERCIAL	Rubbermaid HYGEN™ Microfiber Dust Mops, Microfiber Looped-End Dust Mop, Trapper®	Kut-A-Way®	Disposable Cut-End Blended
FOODSERVICE	Rubbermaid HYGEN™ Microfiber Dust Mops, Microfiber Looped-End Dust Mop, Twisted Loop	Kut-A-Way®	Disposable Cut-End Blended
OFFICE BUILDINGS	Rubbermaid HYGEN™ Microfiber Dust Mops, Microfiber Looped-End Dust Mop, Twisted Loop	Kut-A-Way®	Disposable Cut-End Blended
HOSPITALITY	Rubbermaid HYGEN™ Microfiber Dust Mops, Microfiber Looped-End Dust Mop, Twisted Loop	Kut-A-Way®	Disposable Cut-End Blended

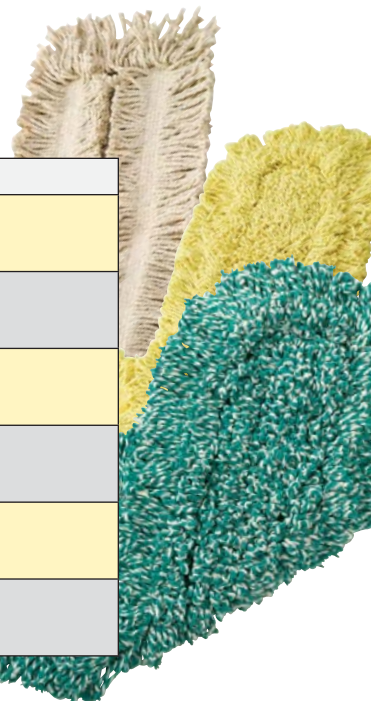

RUBBERMAID HYGEN™ DUST MOPS
CAPTURE AND REMOVE MORE DIRT AND DUST

Rubbermaid HYGEN™ Dust Mops remove up to 80% more dust and dirt than traditional cotton dust mops. Durable up to 500 launderings (200 with bleach). Certified to tolerate CDC hot and cold water laundering requirements.



Microfiber Looped-End Dust Mop

Featuring the cleaning power of microfiber combined with famous high-quality Rubbermaid construction.

- Constructed with a blend of continuous-filament microfiber and traditional spun staple mop yarn
- Withstands twice the laundry cycles of traditional dust mops
- Works with all traditional dust mop handles and frames
- Recycled content: up to 28% post-industrial cotton and 42% PET plastic

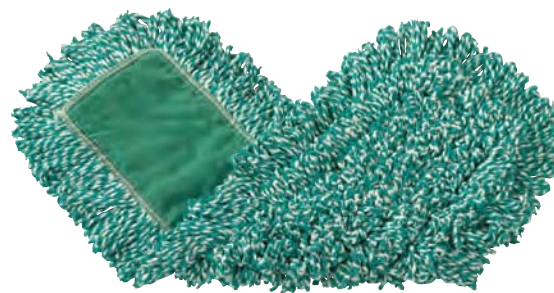

FGJ85300

No.	Mop Color	Description	U.S. Mop Size	U.S. Ship Wt/Ctn	Metric Mop Size	Metric Ship Wt/Ctn	Pack
FGJ85200	GR00	Microfiber Loop Dust Mop 18"	18" l x 5" w	9.25 lb	45.7 cm x 12.7 cm	4.2 kg	12
FGJ85300	GR00	Microfiber Loop Dust Mop 24"	24" l x 5" w	11.7 lb	61 cm x 12.7 cm	5.3 kg	12
FGJ85500	GR00	Microfiber Loop Dust Mop 36"	36" l x 5" w	15.0 lb	91.4 cm x 12.7 cm	6.8 kg	12
FGJ85700	GR00	Microfiber Loop Dust Mop 48"	48" l x 5" w	18.7 lb	121.9 cm x 12.7 cm	8.5 kg	12
FGJ85800	GR00	Microfiber Loop Dust Mop 60"	60" l x 5" w	22.4 lb	152.4 cm x 12.7 cm	10.2 kg	12
FGJ85900	GR00	Microfiber Loop Dust Mop 72"	72" l x 5" w	22.4 lb	182.9 cm x 12.7 cm	10.2 kg	12

Twisted-Loop Dust Mops

Premium prelaundered dust mops provide maximum durability and optimal cleaning performance. Twisted-Loops create fuller mop heads with no gaps, offering better coverage than traditional ply yarn and improved collection and retention of dust and dirt particles.

- Blended antimicrobial mops are specially treated to help inhibit the growth of bacteria
- Less prone to snagging, fraying, and unraveling
- Slip-on backing for easy setup
- Durable polyester backing designed for launderable printing
- *Handles sold separately; see Dust Mop Frames and Handles*

FGK75300 WH00 / FGJ25300 BL00 / FGJ25300 YL00
/ FGJ55300 GR00 / FGJ35300 BL00



BLENDED ANTIMICROBIAL (Recycled content: up to 80%)

No.	Color	Description	U.S. Mop Size	Ship Wt/Ctn (Lbs)	Metric Mop Size	Metric Ship Wt/Ctn	Pack Size
FGJ55200	GR00	Twisted-Loop Blend Antimicrobial Dust Mop	18" l x 5" w	9.2 lb	45.7 cm x 12.7 cm	4.2 kg	12
FGJ55300	GR00	Twisted-Loop Blend Antimicrobial Dust Mop	24" l x 5" w	12.4 lb	61 cm x 12.7 cm	5.6 kg	12
FGJ55500	GR00	Twisted-Loop Blend Antimicrobial Dust Mop	36" l x 5" w	17.7 lb	91.4 cm x 12.7 cm	8 kg	12
FGJ55700	GR00	Twisted-Loop Blend Antimicrobial Dust Mop	48" l x 5" w	22.4 lb	121.9 cm x 12.7 cm	10.2 kg	12
FGJ55800	GR00	Twisted-Loop Blend Antimicrobial Dust Mop	60" l x 5" w	25.2 lb	152.4 cm x 12.7 cm	11.4 kg	12



SYNTHETIC (Recycled content: up to 60% PET plastic)

No.	Color	Description	U.S. Mop Size	Ship Wt/Ctn (Lbs)	Metric Mop Size	Metric Ship Wt/Ctn	Pack Size
FGJ35200	BL00	Twisted-Loop Synthetic Dust Mop	18" l x 5" w	9.2 lb	45.7 cm x 12.7 cm	4.2 kg	12
FGJ35300	BL00	Twisted-Loop Synthetic Dust Mop	24" l x 5" w	12.4 lb	61 cm x 12.7 cm	5.6 kg	12
FGJ35500	BL00	Twisted-Loop Synthetic Dust Mop	36" l x 5" w	17.7 lb	91.4 cm x 12.7 cm	8 kg	12
FGJ35700	BL00	Twisted-Loop Synthetic Dust Mop	48" l x 5" w	22.4 lb	121.9 cm x 12.7 cm	10.2 kg	12
FGJ35800	BL00	Twisted-Loop Synthetic Dust Mop	60" l x 5" w	25.2 lb	152.4 cm x 12.7 cm	11.4 kg	12



BLENDED (Recycled content: Yellow Mops are up to 62% PIC and 10% PET; Blue Mops are up to 65% PIC and 35% PET)

No.	Color	Description	U.S. Mop Size	Ship Wt/Ctn (Lbs)	Metric Mop Size	Metric Ship Wt/Ctn	Pack Size
FGJ25200	YL00, BL00	Twisted-Loop Blend Dust Mop	18" l x 5" w	9.2 lb	45.7 cm x 12.7 cm	4.2 kg	12
FGJ25300	YL00, BL00	Twisted-Loop Blend Dust Mop	24" l x 5" w	12.4 lb	61 cm x 12.7 cm	5.6 kg	12
FGJ25500	YL00, BL00	Twisted-Loop Blend Dust Mop	36" l x 5" w	17.7 lb	91.4 cm x 12.7 cm	8 kg	12
FGJ25700	YL00, BL00	Twisted-Loop Blend Dust Mop	48" l x 5" w	22.4 lb	121.9 cm x 12.7 cm	10.2 kg	12
FGJ25800	YL00, BL00	Twisted-Loop Blend Dust Mop	60" l x 5" w	25.2 lb	152.4 cm x 12.7 cm	11.4 kg	12



COTTON (Recycled content: up to 100% post-industrial cotton)

No.	Color	Description	U.S. Mop Size	Ship Wt/Ctn (Lbs)	Metric Mop Size	Metric Ship Wt/Ctn	Pack Size
FGK75200	WH00	Twisted-Loop Cotton Dust Mop	18" l x 5" w	9.2 lb	45.7 cm x 12.7 cm	4.2 kg	12
FGK75300	WH00	Twisted-Loop Cotton Dust Mop	24" l x 5" w	12.4 lb	61 cm x 12.7 cm	5.6 kg	12
FGK75500	WH00	Twisted-Loop Cotton Dust Mop	36" l x 5" w	17.7 lb	91.4 cm x 12.7 cm	8 kg	12
FGK75700	WH00	Twisted-Loop Cotton Dust Mop	48" l x 5" w	22.4 lb	121.9 cm x 12.7 cm	10.2 kg	12
FGK75800	WH00	Twisted-Loop Cotton Dust Mop	60" l x 5" w	25.2 lb	152.4 cm x 12.7 cm	11.4 kg	12

WHEN ORDERING PRODUCTS WITH **BOLD** COLOR CODES,
PLEASE SPECIFY COLOR CODE AFTER THE PRODUCT NUMBER.
REFER TO THE PRODUCT COLOR GUIDE AT THE BACK OF THE CATALOG.



Check out the items marked with this symbol for our new line of Executive Series™ products.

Trapper® Dust Mops

Looped-end, balanced-blend dust mop for general-purpose dust mopping.

- Pretreated, preshrunk, and fully launderable for long product life
- Slip-on backing for easy setup
- All-sewn construction
- Recycled content: up to 65% post-industrial cotton and 35% PET plastic



FGJ15700

No.	Color	Description	U.S. Mop Size	U.S. Ship Wt/Ctn	Metric Mop Size	Metric Ship Wt/Ctn	Pack
FGJ15100*	YLOO	Trapper® Dust Mop	12" l x 5" w	8.0 lb	30.5 cm x 12.7 cm	3.6 kg	12
FGJ15700*	YLOO	Trapper® Dust Mop	48" l x 5" w	21.0 lb	121.9 cm x 12.7 cm	9.5 kg	12

*Available in 3-pack (-03).

Kut-A-Way® Dust Mops

Cut-end mop excellent for general-purpose dust mopping.

- Prelaundered and preshrunk
- Launderable for long product life
- Envelope-end backing style
- All sewn construction
- Recycled content: colors are up to 65% post-industrial cotton and 35% PET plastic; white is up to 100% post-industrial cotton



FGK15700

No.	Color	Description	U.S. Mop Size	U.S. Ship Wt/Ctn	Metric Mop Size	Metric Ship Wt/Ctn	Pack
FGK15200	WH00, BLOO	Kut-A-Way® Dust Mop	18" l x 5" w	9.0 lb	45.7 cm x 12.7 cm	4.1 kg	12
FGK15300	WH00, BLOO	Kut-A-Way® Dust Mop	24" l x 5" w	11.0 lb	61 cm x 12.7 cm	5 kg	12
FGK15500	WH00, BLOO	Kut-A-Way® Dust Mop	36" l x 5" w	16.0 lb	91.4 cm x 12.7 cm	7.3 kg	12
FGK15700	WH00, BLOO	Kut-A-Way® Dust Mop	48" l x 5" w	21.0 lb	121.9 cm x 12.7 cm	9.5 kg	12
FGK15800	WH00	Kut-A-Way® Dust Mop	60" l x 5" w	26.0 lb	152.4 cm x 12.7 cm	11.8 kg	12
FGK15900	WH00	Kut-A-Way® Dust Mop	72" l x 5" w	31.0 lb	182.9 cm x 12.7 cm	14.1 kg	12

Disposable Cut-End Blended Dust Mops

Soft, open-twist blended cut-end yarn for increased dust pickup.

- Pretreated and mops up to 500,000 sq ft (46,450 m²) before needing replacement
- Envelope-end backing style and durable Tytar® backing
- Recycled content: colors are up to 65% post-industrial cotton and 35% PET plastic



FGL15700

No.	Color	Description	U.S. Mop Size	U.S. Ship Wt/Ctn	Metric Mop Size	Metric Ship Wt/Ctn	Pack
FGL15200*	WH00	Blended Cut-End Disposable Dust Mop	18" l x 5" w	8.0 lb	45.7 cm x 12.7 cm	3.6 kg	12
FGL15300	GR00, WH00	Blended Cut-End Disposable Dust Mop	24" l x 5" w	9.0 lb	61 cm x 12.7 cm	4.1 kg	12
FGL15500	GR00, WH00	Blended Cut-End Disposable Dust Mop	36" l x 5" w	13.0 lb	91.4 cm x 12.7 cm	5.9 kg	12
FGL15700	GR00, WH00	Blended Cut-End Disposable Dust Mop	48" l x 5" w	17.0 lb	121.9 cm x 12.7 cm	7.7 kg	12
FGL15800	WH00	Blended Cut-End Disposable Dust Mop	60" l x 5" w	21.0 lb	152.4 cm x 12.7 cm	9.5 kg	12
FGL15900	WH00	Blended Cut-End Disposable Dust Mop	72" l x 5" w	25.0 lb	182.9 cm x 12.7 cm	11.3 kg	12

*Available in 3 pack (-03).

HANDLES FOR ALL OF THESE MOPS CAN BE FOUND ON PAGE 84.

Disposable Cut-End Cotton Dust Mops

Economical cotton cut-end dust mop.

- Pretreated, with envelope-end backing style
- Recycled content: up to 100% post-industrial cotton



No.	Color	Description	U.S. Mop Size	U.S. Ship Wt/Ctn	Metric Mop Size	Metric Ship Wt/Ctn	Pack
FGL25200	WH00	Cut-End Disposable Cotton Dust Mop	18" l x 5" w	8.0 lb	45.7 cm x 12.7 cm	3.6 kg	12
FGL25300	WH00	Cut-End Disposable Cotton Dust Mop	24" l x 5" w	9.0 lb	61 cm x 12.7 cm	4.1 kg	12
FGL25500	WH00	Cut-End Disposable Cotton Dust Mop	36" l x 5" w	13.0 lb	91.4 cm x 12.7 cm	5.9 kg	12
FGL25700	WH00	Cut-End Disposable Cotton Dust Mop	48" l x 5" w	17.0 lb	121.9 cm x 12.7 cm	7.7 kg	12

Contents for Microfiber Kits shown on page 54.

Each kit comes complete with the cart and accessories shown.

1784284 – Rubbermaid HYGEN™ Microfiber Kit with Charging Bucket

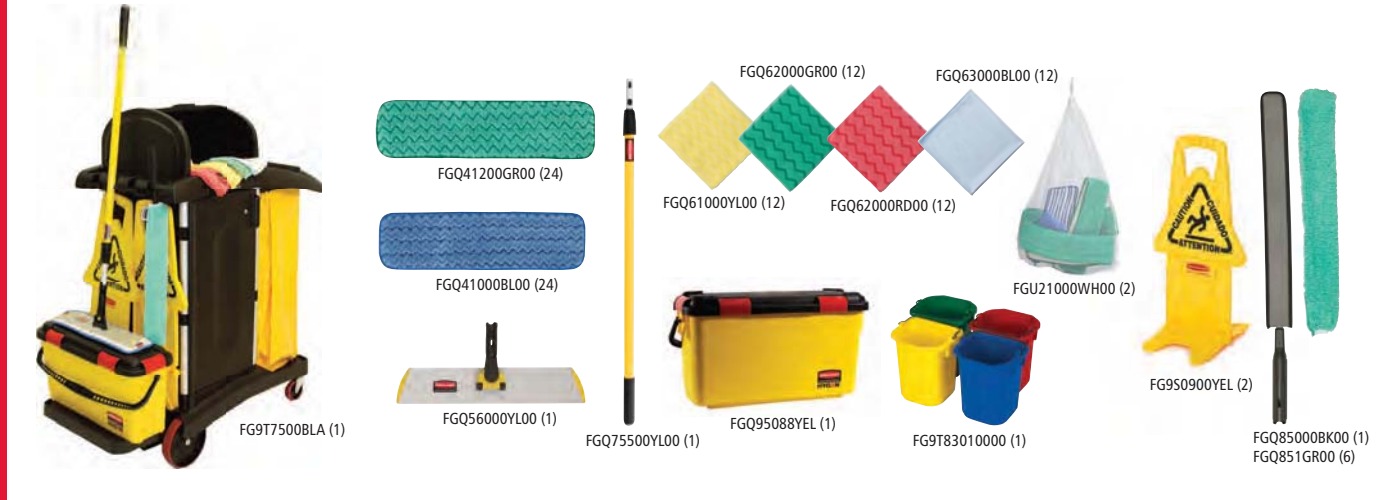

1784285 – Rubbermaid HYGEN™ Microfiber Kit with Rubbermaid PULSE™

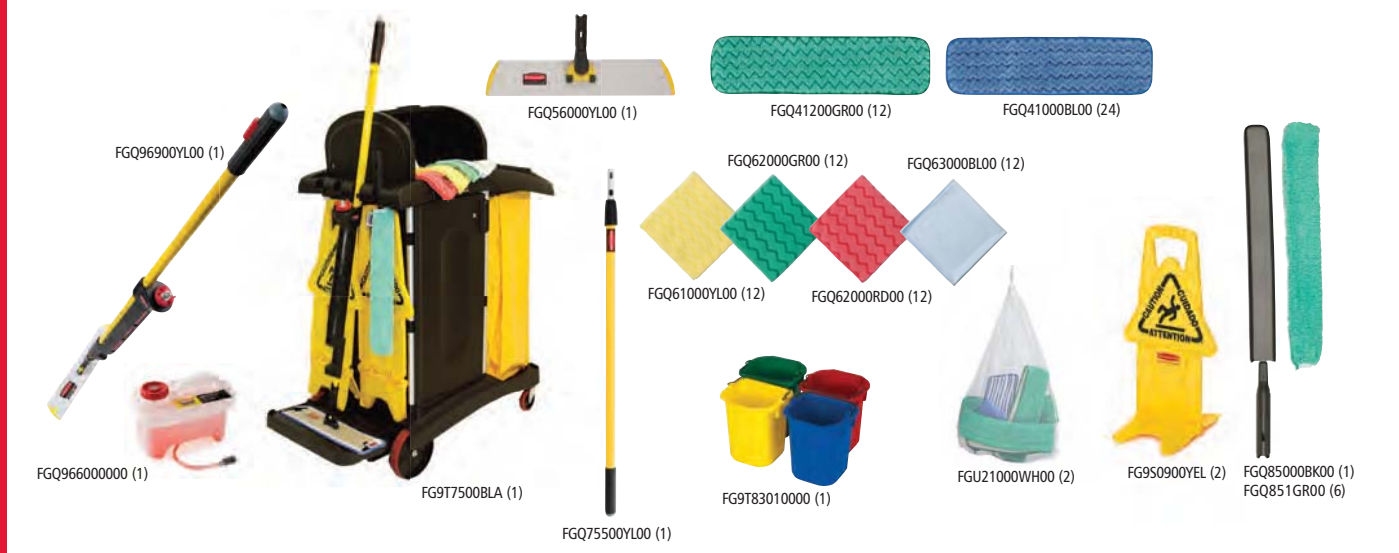

WHEN ORDERING PRODUCTS WITH **BOLD** COLOR CODES, PLEASE SPECIFY COLOR CODE AFTER THE PRODUCT NUMBER. REFER TO THE PRODUCT COLOR GUIDE AT THE BACK OF THE CATALOG.



Check out the items marked with this symbol for our new line of Executive Series™ products.

Cut-to-Length Dust Mops

Cuts floor cleaning costs down to size.

- Continuous 40' (12.2 m) roll yields 20% savings over conventional dust mops
- Cut-to-length convenience lets you customize your mop to fit any standard mop frame
- Untreated, cut-end 4-ply cotton yarn provides excellent dust pickup; durable Typar® backing for long life
- Slip-on backing for easy setup
- Recycled content: up to 100% post-industrial cotton



FGM15000

No.	Color	Description	U.S. Dimensions	U.S. Carton Dimensions	U.S. Ship Wt/Ctn	Metric Dimensions	Metric Carton Dimensions	Metric Ship Wt/Ctn	Pack
FGM15000	WH00	Cut-to-Length Dust Mop	40' l x 5" w	18 1/4" l x 11 1/4" w x 12 1/2" h	13.0 lb	101.6 cm x 12.7 cm	46.4 cm x 29.8 cm x 32.1 cm	5.9 kg	1

Dust Cloth Holder and Stretch Dust Cloths

Effective for general dust mopping.

- For use with 1" (2.5 cm) or smaller handles
- Stretch-activated dust cloths are pretreated and disposable



FGQ32200



FGQ32600

No.	Color	Description	U.S. Size	U.S. Ship Wt/Ctn	Metric Size	Metric Ship Wt/Ctn	Pack
FGQ32200	BK00	Dust Cloth Holder	21" l	10.0 lb	53.3 cm	4.5 kg	6
FGQ32600	YL00	Stretch Cleaning and Dusting Cloth	24" sq	30.0 lb	61 cm sq	13.6 kg	1/400

Wedge Mop System

For spot dust mopping in tight corners, under equipment, or behind furniture.

- Offered in Trapper® looped-end or Kut-A-Way® cut-end triangle-shaped wedge mops
- Wood handle with heavy-gauge plated wire frame fits either style head
- Envelope-end backing style
- U120 contains up to 35% PET plastic



FGU12000



FGU13000



FGU11000

No.	Color	Description	U.S. Ship Wt/Ctn	Metric Ship Wt/Ctn	Pack
FGU11000	0000	Wedge Mop Handle and Frame, Wood Handle with Metal Frame	17.0 lb	7.7 kg	12
FGU12000	YL00	Trapper® Wedge Mop Dust Mop Head, Looped-End	5.5 lb	2.5 kg	12
FGU13000	WH00	Kut-A-Way® Wedge Mop Dust Mop Head, Cut-End	5.5 lb	2.5 kg	12
FGU13067	WH00	Kut-A-Way® Wedge Mop Kit, Contains FGU13000 Mop, FGU11000 Handle, and Frame	3.0 lb	1.4 kg	1

Snap-On Wire Dust Mop Frames

Corrosion-resistant, powder-coated, heavy-duty metal frame for durable performance.



FGM25100



No.	Color	Description	U.S. Dimensions	U.S. Ship Wt/Ctn	Metric Dimensions	Metric Ship Wt/Ctn	Pack
FGM25100	0000	Snap-On Wire Dust Mop Frame	12" l x 5" w	9.0 lb	30.5 cm x 12.7 cm	4.1 kg	12
FGM25200	0000	Snap-On Wire Dust Mop Frame	18" l x 5" w	12.0 lb	45.7 cm x 12.7 cm	5.4 kg	12
FGM25300	0000	Snap-On Wire Dust Mop Frame	24" l x 5" w	14.0 lb	61 cm x 12.7 cm	6.4 kg	12
FGM25500	0000	Snap-On Wire Dust Mop Frame	36" l x 5" w	18.0 lb	91.4 cm x 12.7 cm	8.2 kg	12
FGM25700	0000	Snap-On Wire Dust Mop Frame	48" l x 5" w	22.0 lb	121.9 cm x 12.7 cm	10 kg	12
FGM25800	0000	Snap-On Wire Dust Mop Frame	60" l x 5" w	27.0 lb	152.4 cm x 12.7 cm	12.2 kg	12
FGM25900	0000	Snap-On Wire Dust Mop Frame	72" l x 5" w	33.0 lb	182.9 cm x 12.7 cm	15 kg	12

Snap-On Dust Mop Handles

Available in easily sanitized, vinyl-covered wood, fiberglass, or hardwood handles.

- Spring-loaded clip easily attaches to the Snap-On Dust Mop Frame
- Sliding collar locks the handle into position or swivels a full 360°

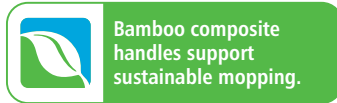

FGM11600

No.	Color	Description	U.S. Dimensions	U.S. Ship Wt/Ctn	Metric Dimensions	Metric Ship Wt/Ctn	Pack
FGM11600	0000	Snap-On Dust Mop Handle, Hardwood	60" l	26.0 lb	152.4 cm	11.8 kg	12
FGM11700	0000	Snap-On Dust Mop Handle, Bamboo Composite	60" l	22.9 lb	152.4 cm	11.8 kg	12
FGM13600	0000	Snap-On Dust Mop Handle, Vinyl-Covered, Hardwood	60" l	26.0 lb	152.4 cm	11.8 kg	12
FGM14600	0000	Snap-On Dust Mop Handle, Fiberglass	60" l	24.0 lb	152.4 cm	10.9 kg	12

WHEN ORDERING PRODUCTS WITH **BOLD** COLOR CODES, PLEASE SPECIFY COLOR CODE AFTER THE PRODUCT NUMBER. REFER TO THE PRODUCT COLOR GUIDE AT THE BACK OF THE CATALOG.



Check out the items marked with this symbol for our new line of Executive Series™ products.

Microfiber Carpet Bonnets

Best-in-the-industry microfiber provides better cleaning power and longer product life. Microfiber Carpet Bonnets work with standard rotary floor machines.

- Standard thickness bonnets work well with shampoo or solvent-based chemicals; use with 175 RPM floor machines
- The low-profile bonnet provides improved operator control on rotary floor machines from 175 to 300 RPM



MICROFIBER CARPET BONNETS

No.	Color	Description	U.S. Dimensions	U.S. Ship Wt/Ctn	Metric Dimensions	Metric Ship Wt/Ctn	Pack
FGQ25700	WH00	17" Microfiber Carpet Bonnet	17" dia	8.0 lb	43.2 cm dia	3.6 kg	5
FGQ25900	WH00	19" Microfiber Carpet Bonnet	19" dia	9.0 lb	48.3 cm dia	4.1 kg	5
FGQ26100	WH00	21" Microfiber Carpet Bonnet	21" dia	10.0 lb	53.3 cm dia	4.5 kg	5



LOW-PROFILE MICROFIBER CARPET BONNETS

No.	Color	Description	U.S. Dimensions	U.S. Ship Wt/Ctn	Metric Dimensions	Metric Ship Wt/Ctn	Pack
FGQ21700	WH00	17" Low-Profile Microfiber Carpet Bonnet	17" dia	8.1 lb	43.2 cm dia	3.7 kg	5
FGQ21900	WH00	19" Low-Profile Microfiber Carpet Bonnet	19" dia	9.2 lb	48.3 cm dia	4.2 kg	5
FGQ22100	WH00	21" Low-Profile Microfiber Carpet Bonnet	21" dia	10.1 lb	53.3 cm dia	4.6 kg	5



Carpet Bonnets

Use with a standard rotary floor machine for interim carpet maintenance.

- Standard thickness, original blend bonnets work well with either shampoo or solvent-based chemicals; use with a 175 RPM floor machine
- The low-profile bonnet provides improved operator control on rotary floor machines from 175 to 300 RPM
- The low-profile bonnet with scrub strips adds additional scrubbing action for improved cleaning performance



STANDARD THICKNESS

No.	Color	Description	U.S. Dimensions	U.S. Ship Wt/Ctn	Metric Dimensions	Metric Ship Wt/Ctn	Pack
FGP11700	WH00	Standard Thickness Bonnet	17" dia	8.0 lb	43.2 cm dia	3.6 kg	5
FGP11900	WH00	Standard Thickness Bonnet	19" dia	9.0 lb	48.3 cm dia	4.1 kg	5
FGP12100	WH00	Standard Thickness Bonnet	21" dia	10.0 lb	53.3 cm dia	4.5 kg	5



LOW-PROFILE

No.	Color	Description	U.S. Dimensions	U.S. Ship Wt/Ctn	Metric Dimensions	Metric Ship Wt/Ctn	Pack
FGP25700	WH00	Low-Profile Bonnet	17" dia	8.0 lb	43.2 cm dia	3.6 kg	5
FGP25900	WH00	Low-Profile Bonnet	19" dia	9.0 lb	48.3 cm dia	4.1 kg	5
FGP26100	WH00	Low-Profile Bonnet	21" dia	10.0 lb	53.3 cm dia	4.5 kg	5



LOW-PROFILE WITH GREEN SCRUB STRIPS

No.	Color	Description	U.S. Dimensions	U.S. Ship Wt/Ctn	Metric Dimensions	Metric Ship Wt/Ctn	Pack
FGP26700	WH00	Low-Profile with Green Scrub Strips Bonnet	17" dia	8.0 lb	43.2 cm dia	3.6 kg	5
FGP26900	WH00	Low-Profile with Green Scrub Strips Bonnet	19" dia	9.0 lb	48.3 cm dia	4.1 kg	5
FGP27100	WH00	Low-Profile with Green Scrub Strips Bonnet	21" dia	10.0 lb	53.3 cm dia	4.5 kg	5



BROOM AND BRUSH CONSTRUCTION

Surface textures and types of dirt vary throughout a facility, so choosing the correct broom and brush construction is important for maximum cleaning effectiveness. Rubbermaid Commercial Products' brooms and brushes offer a complete range of blocks and fill types to clean virtually any surface.



BLOCK STRUCTURES



STRUCTURAL FOAM BLOCK

Resists cracking, splitting, warping, and rotting. Helps prevent bacteria growth. Two threaded holes provide long product life.



WOOD BLOCK

A classic look that resists moisture and helps prevent cracking. Two threaded holes provide long product life.



BLOCK AND FILL DESIGN

Staggered hole pattern prevents gaps in fill material for better performance. Dense fill leads to longer brush life. Flagged tips pick up fine dust and dirt particles. Flared ends allow access to corners.

FILL—NATURAL



HORSEHAIR

Very durable with a naturally flagged tip; good shear/break resistance. Will not scratch smooth or highly polished surfaces. Not for use on oily or wet surfaces.



PALMYRA

Medium to highly stiff fiber from the Palmyra Palm provides durability and good bristle recovery. Can be used wet or dry.



TAMPICO

Soft to medium stiff fiber from the Agave plant. Durable and retains shape after continual use. High resistance to heat, alkali, solvents, and acid. Can be used wet or dry.

FILL—SYNTHETIC



NYLON

Very durable with excellent abrasion resistance, shear/break strength, and bristle bend recovery. Will not stain, discolor, or absorb odors. Can be used wet or dry and resistant to alkalis and most solvents.



POLYSTYRENE

Extremely durable. Excellent bristle bend recovery and shear/break strength. Resistant to water, oils, and solvents. Not for sweeping compounds or oily surfaces.



POLYPROPYLENE

Very durable with good abrasion resistance and shear/break strength. Will not stain, discolor, or absorb odors. Resistant to solvents, acids, oils, fungus, and bacteria growth. Can be used wet or dry.

FILL—WIRE/METAL



BRASS

Provides a high degree of abrasion without severely scratching hard surfaces. Will not rust. Best for heavy cleaning of metal or brick surfaces that cannot sustain heavy scratches.



STAINLESS STEEL

Provides a high degree of abrasion and wear resistance. Resists chemicals and rust. Excellent bend recovery. Best for aggressively removing residue from metal or other resilient materials.



TEMPERED STEEL

Provides a high degree of abrasion and wear resistance. Good bend recovery. Best for aggressively removing residue from metal parts or brick work.

WHEN ORDERING PRODUCTS WITH **BOLD** COLOR CODES, PLEASE SPECIFY COLOR CODE AFTER THE PRODUCT NUMBER. REFER TO THE PRODUCT COLOR GUIDE AT THE BACK OF THE CATALOG.



Check out the items marked with this symbol for our new line of Executive Series™ products.

Angle Brooms

Ideal for cleaning hard-to-reach areas.

- Cut and shaped for easy sweeping
- Long-lasting, stain-resistant polypropylene bristles
- Permanent fusion-set bristles won't pull out



No.	Color	Description	Sweep Face	U.S. Ship Wt/Ctn	Metric Ship Wt/Ctn	Pack
New! ⑤ FG637500	GRAY	Broom, 1" dia (2.5 cm) Vinyl-Coated Metal Handle, Flagged Polypropylene Fill	10.5"	10.2 lb	4.6 kg	6
1861076	BLACK	Executive Series™ Broom, 1 1/8" dia (4.92 cm) Vinyl-Coated Metal Handle, Flagged Polypropylene Fill	10.5"	10.2 lb	4.6 kg	6
New! ⑤ FG638500	GRAY	Broom, 1" dia (2.5 cm) Metal Handle, Flagged Polypropylene Fill	10.5"	9.6 lb	4.4 kg	6
1861078	BLACK	Executive Series™ Broom, 1" dia (2.5 cm) Metal Handle, Flagged Polypropylene Fill	10.5"	9.6 lb	4.4 kg	6
FG638906	BLA	Jumbo Smooth Sweep Angle Broom, 1 1/8" dia (4.76 cm) Black Metal Handle, Polypropylene Fill	10"	26.5 lb	12 kg	6
FG639700	GRAY	Broom Replacement Head, Thread fits FG635100, FG635500 Handles	10.5"	12.0 lb	5.4 kg	12

Corn Brooms

Designed for rugged indoor/outdoor cleaning.

- 100% natural broom corn fibers for long life and effective pickup
- Remove fine dirt from even or rough surfaces
- Hand-selected, heavy-duty lacquered pine handles



No.	Thread Color	Description	Sweep Face	U.S. Sizes	U.S. Ship Wt/Ctn	Metric Sizes	Metric Ship Wt/Ctn	Pack
FG638100	RED	Corn Broom, Standard, 1" dia (2.5 cm) Stained/Lacquered Handle	12"	24 lb	23.7 lb	10.9 kg	10.8 kg	12
FG638300	BLUE	Corn Broom, Warehouse, 1.13" dia (2.9 cm) Stained/Lacquered Handle	12"	31 lb	30.0 lb	14.1 kg	13.6 kg	12
FG638400	ORAN	Corn Broom, Warehouse, 1.13" dia (2.9 cm) Stained/Lacquered Handle	12"	35.5 lb	35.5 lb	15.9 kg	16.1 kg	12

Fine Floor Sweeps

Designed to pick up the finest debris.

- Available in flagged polypropylene or blended horsehair/tampico for removing the finest dirt and dust
- Ideal for highly polished or waxed floors
- Accepts threaded handle on either side for even wear
- Optional angle brace adds support and stability; see page 88
- *Handles sold separately*



No.	Bristle Color	Description	Trim Length	U.S. Dimensions	U.S. Ship Wt/Ctn	Metric Dimensions	Metric Ship Wt/Ctn	Pack
FG9B0000	GRAY	Plastic Foam Block, Fine Floor Sweep, Flagged Polypropylene Fill	3"	18" l	19.0 lb	45.7 cm	8.6 kg	12
FG9B0100	BLA	Plastic Foam Block, Fine Floor Sweep, Tampico Fill with Horsehair Border	3"	18" l	19.0 lb	45.7 cm	8.6 kg	12
FG9B0200	GRAY	Plastic Foam Block, Fine Floor Sweep, Flagged Polypropylene Fill	3"	24" l	25.0 lb	61 cm	11.3 kg	12
New! ⑤ 1861213	LIGHT GRAY	Executive Series™ Plastic Foam Block, Fine Floor Sweep, Flagged Polypropylene Fill	3"	24" l	25.0 lb	61 cm	11.3 kg	12
FG9B0300	BLA	Plastic Foam Block, Fine Floor Sweep, Tampico Fill with Horsehair Mix Border	3"	24" l	25.0 lb	61 cm	11.3 kg	12
FG9B0400	GRAY	Hardwood Block, Fine Floor Sweep, Flagged Polypropylene Fill	3"	36" l	8.5 lb	91.4 cm	3.9 kg	2
FG9B0500	BLA	Hardwood Block, Fine Floor Sweep, Tampico Fill with Horsehair Border	3"	36" l	8.5 lb	91.4 cm	3.9 kg	2

HANDLES FOR ALL OF THESE BROOMS CAN BE FOUND ON PAGE 89.

Medium Floor Sweeps

Designed to round up heavier dirt from multiple floor surfaces.

- Long-lasting, multisurface polypropylene and natural tampico bristles are ideal for light to medium debris on both smooth and rough floor surfaces
- Accepts threaded handle on either side for even wear
- Optional angle brace adds support and stability; see below
- *Handles sold separately*



No.	Bristle Color	Description	Trim Length	U.S. Dimensions	U.S. Ship Wt/Ctn	Metric Dimensions	Metric Ship Wt/Ctn	Pack
FG9B0600	BLA	Plastic Foam Block, Medium Floor Sweep, Polypropylene Fill	3"	18" l	19.0 lb	45.7 cm	8.6 kg	12
FG9B0700	BLA	Plastic Foam Block, Medium Floor Sweep, Tampico Fill	3"	18" l	19.0 lb	45.7 cm	8.6 kg	12
FG9B0800	GRAY	Plastic Foam Block, Medium Floor Sweep, Multisurface, Polypropylene Fill, Flagged Border	3"	18" l	19.0 lb	45.7 cm	8.6 kg	12
FG9B0900	BLA	Plastic Foam Block, Medium Floor Sweep, Polypropylene Fill	3"	24" l	25.0 lb	61 cm	11.3 kg	12
New! ES 1861211	GRAY	Executive Series™ Plastic Foam Block, Medium Floor Sweep, Polypropylene Fill	3"	24" l	25.0 lb	61 cm	11.3 kg	12
FG9B1000	BLA	Plastic Foam Block, Medium Floor Sweep, Tampico Fill	3"	24" l	25.0 lb	61 cm	11.3 kg	12
FG9B1100	GRAY	Plastic Foam Block, Medium Floor Sweep, Multisurface, Polypropylene Fill, Flagged Border	3"	24" l	25.0 lb	61 cm	11.3 kg	12
FG9B1200	BLA	Hardwood Block, Medium Floor Sweep, Polypropylene Fill	3"	36" l	8.5 lb	91.4 cm	3.9 kg	2
FG9B1300	BLA	Hardwood Block, Medium Floor Sweep, Tampico Fill	3"	36" l	8.5 lb	91.4 cm	3.9 kg	2
FG9B1400	GRAY	Hardwood Block, Medium Floor Sweep, Multisurface, Polypropylene Fill, Flagged Border	3"	36" l	8.5 lb	91.4 cm	3.9 kg	2

Heavy-Duty Floor Sweeps

Reliability for every industrial-strength job.

- Heavy-duty polypropylene bristles resist stains and odors and are designed for use in the most demanding industrial applications
- Accepts threaded handle on either side for even wear
- Optional angle brace adds support and stability; see below
- *Handles sold separately*



No.	Bristle Color	Description	Trim Length	U.S. Dimensions	U.S. Ship Wt/Ctn	Metric Dimensions	Metric Ship Wt/Ctn	Pack
FG9B1500	MARN	Plastic Foam Block, Heavy-Duty Floor Sweep, Coarse Polypropylene and Polystyrene Fill	2.88"	18" l	19.0 lb	45.7 cm	8.6 kg	12
FG9B1600	BRN	Plastic Foam Block, Heavy-Duty Floor Sweep, Palmyra Fill	2.88"	18" l	19.0 lb	45.7 cm	8.6 kg	12
FG9B1700	MARN	Plastic Foam Block, Heavy-Duty Floor Sweep, Coarse Polypropylene and Polystyrene Fill	2.88"	24" l	25.0 lb	61 cm	11.3 kg	12
New! ES 1861212	BLACK	Executive Series™ Plastic Foam Block, Heavy-Duty Floor Sweep, Coarse Polypropylene and Polystyrene Fill	2.88"	24" l	25.0 lb	61 cm	11.3 kg	12
FG9B1800	BRN	Plastic Foam Block, Heavy-Duty Floor Sweep, Palmyra Fill	2.88"	24" l	25.0 lb	61 cm	11.3 kg	12
FG9B1900	MARN	Hardwood Block, Heavy-Duty Floor Sweep, Coarse Polypropylene and Polystyrene Fill	2.88"	36" l	8.5 lb	91.4 cm	3.9 kg	2
FG9B2000	BRN	Hardwood Block, Heavy-Duty Floor Sweep, Palmyra Fill	3.88"	36" l	8.5 lb	91.4 cm	3.9 kg	2

Wide-Angle Brace for Use with Brace Brooms

Adds increased support for heavy-duty applications.

- Increased reliability for industrial-strength applications
- Brace only; does not include broom or handle



No.	Bristle Color	Description	U.S. Dimensions	U.S. Ship Wt/Ctn	Metric Dimensions	Metric Ship Wt/Ctn	Pack
FG9B7100	0000	Wide-Angle Brace for Fine, Medium, and Heavy-Duty Floor Sweeps	15" l x 4" w x 0.5" h	4.7 lb	38.1 cm x 10.2 cm x 1.3 cm	2.1 kg	12

HANDLES FOR ALL OF THESE BROOMS CAN BE FOUND ON PAGE 89.

WHEN ORDERING PRODUCTS WITH BOLD COLOR CODES, PLEASE SPECIFY COLOR CODE AFTER THE PRODUCT NUMBER. REFER TO THE PRODUCT COLOR GUIDE AT THE BACK OF THE CATALOG.



Check out the items marked with this symbol for our new line of Executive Series™ products.

Brace Brooms

Medium- and heavy-duty brooms with long-lasting I-beam construction.

- Tough plastic block will not crack, warp, or mildew
- Heavy-duty metal handle with oversized swivel cap and metal tip
- All brace brooms come fully assembled
- Available in multisurface and coarse polypropylene fills



FGX40204

No.	Color	Description	U.S. Dimensions	U.S. Ship Wt/Ctn	Metric Dimensions	Metric Ship Wt/Ctn	Pack
FGX40204	0000	Plastic Foam Block Brace Broom, Medium-Duty, Multisurface Polypropylene Fill, Fine Flagged Border	24" l x 5" w x 64" h	15.3 lb	61 cm x 12.7 cm x 162.6 cm	6.9 kg	4
FGX40804	0000	Plastic Foam Block Brace Broom, Heavy-Duty, Coarse Polypropylene Fill	24" l x 5" w x 64" h	22.3 lb	61 cm x 12.7 cm x 162.6 cm	10.1 kg	4

Street Sweeps

For the most demanding rough surfaces.

- Wide flared ends for greater floor coverage and ease when sweeping close to walls or curbs
- Polypropylene bristles are washable for long life
- Accepts tapered handles
- *Handles sold separately*, see below



FG9B2200

No.	Color	Description	Trim Length	U.S. Dimensions	U.S. Ship Wt/Ctn	Metric Dimensions	Metric Ship Wt/Ctn	Pack
FG9B2100	BRN	Street Broom, Hardwood Block, Polypropylene Fill	6"	16" l	12.4 lb	40.6 cm	5.6 kg	4
FG9B2200	BRN	Street Broom, Hardwood Block, Palmyra Fill	6"	16" l	12.4 lb	40.6 cm	5.6 kg	4

Broom Handles

Available in threaded or tapered tips.

- Available in wood or lightweight aluminum

FG635200 / FG636200



FG635100 / FG636100



FG635500



FG636400



FG635700



THREADED

No.	Color	Description	Dimensions	U.S. Ship Wt/Ctn	Metric Dimensions	Metric Ship Wt/Ctn	Pack
FG635100	LAC	Wood Handle, Threaded, Lacquered	1.06" dia x 54" l	11.0 lb	2.7 cm dia x 137.2 cm	5 kg	12
FG635500	GRAY	Aluminum Handle, Threaded Plastic Tip, Vinyl Grip	1" dia x 57" l	10.3 lb	2.5 cm dia x 144.8 cm	4.7 kg	12
FG635700	BLA	Super Self-Locking Wood Handle, Threaded Metal Tip	1.06" dia x 60" l	13.7 lb	2.7 cm dia x 152.4 cm	6.2 kg	12
FG636100	LAC	Wood Handle, Threaded, Lacquered	1.06" dia x 60" l	13.4 lb	2.7 cm dia x 152.4 cm	6.1 kg	12
FG636400	LAC	Wood Handle, Threaded Metal Tip, Lacquered	1.06" dia x 60" l	13.0 lb	2.7 cm dia x 152.4 cm	5.9 kg	12

TAPERED

No.	Color	Description	Dimensions	U.S. Ship Wt/Ctn	Metric Dimensions	Metric Ship Wt/Ctn	Pack
FG635200	NAT	Wood Handle, Tapered, Sanded	1.13" dia x 54" l	16.2 lb	2.9 cm dia x 137.2 cm	7.3 kg	12
FG636200	NAT	Wood Handle, Tapered, Sanded	1.13" dia x 60" l	16.1 lb	2.9 cm dia x 152.4 cm	7.3 kg	12

Counter Brushes/Whisk Broom/Heavy-Duty Dust Pans

Perfect for quick cleanups.

- Counter brushes feature structural foam blocks with tampico or polypropylene fills
- Heavy-duty plastic dust pans come in extra large sizes to hold ample amounts of dirt and debris



FG9B5900

FG9B6000



FG200500



FG9B5500



FG9B2700



FG634100



FG634200

No.	Color	Description	Sweep Face	U.S. Dimensions	U.S. Ship Wt/Ctn	Metric Dimensions	Metric Ship Wt/Ctn	Pack
FG634100	BLA	Plastic Block Counter Brush, Tampico Fill with 8" (20.3 cm) Bristle Coverage	8"	12.5" l	3.1 lb	31.8 cm	1.4 kg	6
FG634200	SILV	Plastic Block Counter Brush, Flagged Polypropylene Fill with 8" (20.3 cm) Bristle Coverage	8"	12.5" l	3.0 lb	31.8 cm	1.4 kg	6
FG9B2700	BLA	Curved Plastic Handle Counter Brush, Polypropylene Fill	8"	8" l	3.1 lb	20.3 cm	1.4 kg	6
FG9B5500	YEL	Corn Whisk Broom	N/A	12.25" l	5.0 lb	31.1 cm	2.3 kg	12
FG200500	CHAR	Heavy-Duty Dust Pan	N/A	12.25" l x 8.25" w	6.2 lb	31.1 cm x 21 cm	2.8 kg	12
FG9B5900	BLA	Extra-Large Dust Pan	N/A	16" l x 14.75" w x 5.38" h	5.3 lb	40.6 cm x 37.5 cm x 13.7 cm	2.4 kg	6
FG9B6000	BLA	Jumbo Dust Pan	N/A	22" l x 18" w x 7.75" h	8.7 lb	55.9 cm x 45.7 cm x 19.7 cm	3.9 kg	6

Plastic Handle Utility Brushes

Long or short handles, synthetic and natural brushes.

- All-plastic structural foam blocks have hang-up hole for easy storage
- Available in both synthetic and natural palmyra bristles
- Ideal for foodservice applications and institutional use
- Choice of 8" or 20" length



FG9B2800

FG9B2900

FG9B3000



FG9B3100

FG9B3300

FG9B3200

No.	Bristle Color	Description	U.S. Dimensions	Trim Length	U.S. Ship Wt/Ctn	Metric Dimensions	Metric Ship Wt/Ctn	Pack
FG9B2800	BRN	Short Plastic-Handle Utility Brush, Palmyra Fill	8" l	2"	3.3 lb	20.3 cm	1.5 kg	6
FG9B2900	YEL	Short Plastic-Handle Utility Brush, Synthetic Fill	8" l	2"	3.3 lb	20.3 cm	1.5 kg	6
FG9B3000	YEL	Short Plastic-Handle Utility Brush, Tampico Fill	8" l	2"	3.3 lb	20.3 cm	1.5 kg	6
FG9B3100	BRN	Long Plastic-Handle Utility Brush, Palmyra Fill	20" l	2"	6.0 lb	50.8 cm	2.7 kg	6
FG9B3200	YEL	Long Plastic-Handle Utility Brush, Synthetic Fill	20" l	2"	6.0 lb	50.8 cm	2.7 kg	6
FG9B3300	YEL	Long Plastic-Handle Utility Brush, Tampico Fill	20" l	2"	6.0 lb	50.8 cm	2.7 kg	6

WHEN ORDERING PRODUCTS WITH **BOLD** COLOR CODES,
PLEASE SPECIFY COLOR CODE AFTER THE PRODUCT NUMBER.
REFER TO THE PRODUCT COLOR GUIDE AT THE BACK OF THE CATALOG.

Truck and Wash Brush and Floor/Deck Scrub

Plastic blocks resist splitting and delaminating.

- Flagged synthetic fibers to help avoid scratching
- Long-lasting, stain-resistant polypropylene bristles
- Extension poles and acme-thread Quick-Connect Adapter available (see page 49)
- *Handles sold separately*

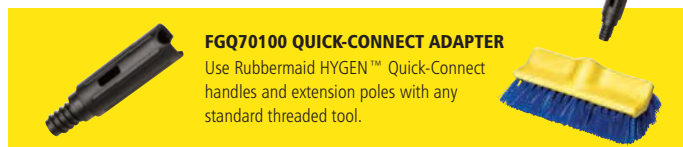

FGQ70100 QUICK-CONNECT ADAPTER

Use Rubbermaid HYGEN™ Quick-Connect handles and extension poles with any standard threaded tool.



No.	Bristle Color	Description	Accepted Handle	U.S. Dimensions	Trim Length	U.S. Ship Wt/Ctn	Metric Dimensions	Metric Ship Wt/Ctn	Pack
FG633700	BLUE	Floor Scrub, Plastic Block, Bi-level, Polypropylene Fill	Threaded	10" l	2"	7.5 lb	25.4 cm	3.4 kg	6
FG9B3400	BRN	Deck Brush, Plastic Block, Palmyra Fill	Threaded	10" l	2"	4.2 lb	25.4 cm	1.9 kg	6
FG9B3500	BRN	Deck Brush, Wood Block, with Squeegee, Palmyra Fill	Threaded or Tapered	14" l	2"	8.6 lb	35.6 cm	3.9 kg	6
FG9B3600	YEL	Deck Brush, Plastic Block, Polypropylene Fill	Threaded	9" l	1"	3.0 lb	22.9 cm	1.4 kg	6
FG9B3700	GRAY	Wash Brush, Plastic Block, Flagged Polystyrene Fill	Threaded or Tapered	10" l	2.5"	4.5 lb	25.4 cm	2 kg	6
FG9B3800	YEL	Wash Brush, Plastic Block, Tampico Fill	Threaded or Tapered	8.5" l	2.5"	3.7 lb	21.6 cm	1.7 kg	6
FG9B3900	YEL	Wash Brush, Round Block, Tampico Fill	Threaded or Tapered	5" l	3.25"	4.4 lb	12.7 cm	2 kg	6
FG9B7200	GRN	Wash Brush, Plastic Block, Nylon Fill	Threaded or Tapered	10" l	2.5"	4.5 lb	25.4 cm	2 kg	6

Masonry Brushes

Nothing beats their reliability.

- Includes convenient hole for hanging
- Synthetic or tampico bristles
- Can also be used for pasting and painting
- *Handles sold separately*



No.	Bristle Color	Description	U.S. Dimensions	Trim Length	U.S. Ship Wt/Ctn	Metric Dimensions	Metric Ship Wt/Ctn	Pack
FG9B4900	YEL	Masonry Brush, Hardwood Handle, Tampico Fill	11.5" l	4"	4.5 lb	29.2 cm	2 kg	6
FG9B5000	YEL	Masonry Brush, Plastic Foam Block Handle, Synthetic Fill	11" l	3.5"	3.3 lb	27.9 cm	1.5 kg	6
FG9B5100*	YEL	Plastic Acid Brush, Tampico and Synthetic Fill	8" l		3.0 lb	20.3 cm	1.4 kg	6

*Accepts threaded handle, sold separately; see page 89.

Wire Brushes

Designed for tough use in difficult areas.

- For efficient removal of rust, paint, and grease
- Wire or steel bristles tackle tough cleaning jobs
- Includes convenient hole for hanging



No.	Color	Description	U.S. Dimensions	Wire Type	U.S. Ship Wt/Ctn	Metric Dimensions	Bristle Pattern	Metric Ship Wt/Ctn	Pack
FG9B4000	GRAY	Wire Brush, Plastic Angular Handle	11" l	Steel	6.6 lb	27.9 cm	3 x 27	3 kg	12
FG9B4100	GRAY	Wire Brush, Short Plastic Handle	11" l	Steel	3.7 lb	27.9 cm	4 x 17	1.7 kg	12
FG9B4200	GRAY	Wire Brush with Scraper, Short Angular Handle	11" l	Steel	4.2 lb	27.9 cm	4 x 17	1.9 kg	12
FG9B4300	GRAY	Wire Brush, Long Plastic Handle	14" l	Steel	4.2 lb	35.6 cm	3 x 19	1.9 kg	12
FG9B4400	GRAY	Wire Brush with Scraper, Long Plastic Handle	14" l	Steel	5.3 lb	35.6 cm	3 x 19	2.4 kg	12
FG9B4500*	GRAY	Wire Brush, Plastic Butcher Block Handle	7" l	Steel	5.6 lb	17.8 cm	6 x 19	2.5 kg	12
FG9B4600	GRAY	Wire Brush, Broad Plastic Handle	11.5" l	Steel	6.0 lb	29.2 cm	4 x 11	2.7 kg	12
FG9B4700	GRAY	Stainless Steel Wire Brush, Short Plastic Handle	11" l	Stainless Steel	3.7 lb	27.9 cm	4 x 17	1.7 kg	12
FG9B5700	0000	Tile and Grout Brush, Brass Bristles	8.5" l	Brass	1.2 lb	21.6 cm	2 x 9	0.5 kg	12

*Accepts threaded handle, sold separately; see page 89.

HANDLES FOR ALL OF THESE BROOMS CAN BE FOUND ON PAGE 89.

Toilet Bowl Brushes and Holders

Available in several handle lengths, head sizes, and styles.

- Polypropylene and crimped polypropylene fills
- Stain and odor resistant



No.	Color	Description	U.S. Dimensions	U.S. Ship Wt/Ctn	Metric Dimensions	Metric Ship Wt/Ctn	Trim Length	Pack
FG630100	YEL	Toilet Bowl Brush, Hardwood Handle, Polypropylene Fill	17" l	2.9 lb	43.2 cm	1.3 kg	1.13 "	12
FG631000	WHT	Toilet Bowl Brush, Plastic Handle, Polypropylene Fill	14.5" l	7.0 lb	36.8 cm	3.2 kg	1.13 "	24
FG631100	WHT	Toilet Bowl Brush Holder, fits FG631000 Brush	5" l	6.5 lb	12.7 cm	2.9 kg		24
FG632000	BRN	Toilet Bowl Brush, Plastic Handle, Polypropylene Fill	17" l	6.0 lb	43.2 cm	2.7 kg	1.5 "	12
FG9B5200	BLUE	Plastic Handle Bowl Brush, Polypropylene Fill	20" l	3.9 lb	50.8 cm	1.8 kg	2"	12

Scrub Brushes

Natural and synthetic fibers set in plastic block.

- Designed to make scrubbing tile and grout lines and cleaning floors, baseboards, walls, and countertops easier



No.	Bristle Color	Description	U.S. Dimensions	U.S. Ship Wt/Ctn	Metric Dimensions	Metric Ship Wt/Ctn	Trim Length	Pack
FG648200	COBLT	Iron Handle Scrub Brush, Polypropylene Fill	6" l	3.4 lb	15.2 cm	1.5 kg	1 "	12
FG9B2300	YEL	Square Block Scrub Brush, Polypropylene Fill	7.4" l	4.7 lb	18.8 cm	2.1 kg	1"	12
FG9B2400	BRN	Square Block Scrub Brush, Palmyra Fill	7.5" l	4.7 lb	19.1 cm	2.1 kg	1"	12
FG9B2500	YEL	Pointed Scrub Brush, Tampico Fill	9" l	5.2 lb	22.9 cm	2.4 kg	1.100"	12
FG9B2600	YEL	Pointed Scrub Brush, Polypropylene Fill	7.5" l	5.2 lb	19.1 cm	2.4 kg	1"	12
FG9B5600	BLA	Tile and Grout Brush, Plastic Bristles	8.5" l	0.8 lb	21.6 cm	0.4 kg	.75"	12
FG9B5800	WHT	Plastic Hand and Nail Brush, Polypropylene Bristles	4.75" l	1.4 lb	12.1 cm	0.6 kg	.75 "	12

Wall Washer Kit

Pivoting head for smooth, even control.

- Raised-ribbed design works with either side pressure or downward pressure mop wringers without requiring additional adapters
- Washable pads remove easily for laundering



No.	Color	Description	U.S. Dimensions	U.S. Ship Wt/Ctn	Metric Dimensions	Metric Ship Wt/Ctn	Pack
FGS21600	GY00	Wall Washer Kit Includes 1 Wood Handle, 1 Plastic Head, 2 Cotton Pads	60" l	2.0 lb	152.4 cm	0.9 kg	1
FGS22600	GY00	Wall Washer Kit Includes 1 Aluminum Handle, 1 Plastic Head, 2 Cotton Pads	60" l	2.0 lb	152.4 cm	0.9 kg	1
FGS29900	WH00	Wall Washer Replacement Pads, Launderable Cotton	9" l x 5" w	8.0 lb	22.9 cm x 12.7 cm	3.6 kg	12

WHEN ORDERING PRODUCTS WITH **BOLD** COLOR CODES, PLEASE SPECIFY COLOR CODE AFTER THE PRODUCT NUMBER. REFER TO THE PRODUCT COLOR GUIDE AT THE BACK OF THE CATALOG.



Check out the items marked with this symbol for our new line of Executive Series™ products.

Floor Squeegees

Dual Moss Squeegees

- Nonmarking, flexible blades are ideal for uneven surfaces
- Leaves floors virtually dry to the touch, ideal for spills
- For use in removing liquids and light dirt
- *Handles sold separately*

Traditional Squeegees

- Galvanized metal frame and locking strip
- Fit standard 1 1/8" tapered handles
- Nonmarking 2" black rubber blades
- For removing liquids and heavy dirt
- *Handles sold separately*

Professional Plastic Squeegees

- Rugged, corrosion-resistant polypropylene
- Twin black rubber or red neoprene blades
- For removing liquids, moderate dirt, and quick drying
- Scrub and Dry Squeegee with bristles for extra aggressive scrubbing
- Neoprene has excellent resistance to oils, grease, and most chemicals
- *Handles sold separately*



FG9C2600



FG9C2900



FG9C3100



FG9C3400



FG9C4100

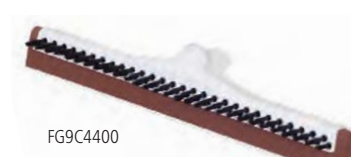

FG9C4400

DUAL MOSS SQUEEGEES

No.	Color	Description	U.S. Dimensions	U.S. Ship Wt/Ctn	Metric Dimensions	Metric Ship Wt/Ctn	Pack
FG9C2600*	BLA	18" (45.7 cm) Standard Floor Squeegee	18" l x 3" w x 4.5" h	5.5 lb	45.7 cm x 7.6 cm x 11.4 cm	2.5 kg	10
FG9C2700*	BLA	22" (55.9 cm) Standard Floor Squeegee	22" l x 3" w x 4.5" h	6.6 lb	55.9 cm x 7.6 cm x 11.4 cm	3 kg	10
FG9C2800*	BLA	22" (55.9 cm) Heavy-Duty Floor Squeegee	22" l x 3.25" w x 5.5" h	13.6 lb	55.9 cm x 8.3 cm x 14 cm	6.2 kg	10
FG9C2900*	BLA	30" (76.2 cm) Heavy-Duty Floor Squeegee	30" l x 3.25" w x 5.5" h	15.8 lb	76.2 cm x 8.3 cm x 14 cm	7.2 kg	10

*Use with tapered or wood handles; see page 89.

TRADITIONAL SQUEEGEES

No.	Color	Description	U.S. Dimensions	U.S. Ship Wt/Ctn	Metric Dimensions	Metric Ship Wt/Ctn	Pack
FG9C3100*	BLA	18" (45.7 cm) Straight Floor Squeegee	18" l x 4" w x 6.8" h	11.1 lb	45.7 cm x 10.2 cm x 17.3 cm	5 kg	6
FG9C3200*	BLA	24" (61 cm) Straight Floor Squeegee	24" l x 4" w x 6.8" h	13.7 lb	61 cm x 10.2 cm x 17.3 cm	6.2 kg	6
FG9C3300*	BLA	36" (91.4 cm) Straight Floor Squeegee	36" l x 4" w x 6.8" h	19.8 lb	91.4 cm x 10.2 cm x 17.3 cm	9 kg	6
FG9C3400*	BLA	24" (61 cm) Curved Floor Squeegee	23.5" l x 4" w x 6.8" h	13.7 lb	59.7 cm x 10.2 cm x 17.3 cm	6.2 kg	6
FG9C3500	BLA	18" (45.7 cm) Replacement Blade for FG9C3100	18" l x 0.25" w x 2" h	2.7 lb	45.7 cm x 0.6 cm x 5.1 cm	1.2 kg	6
FG9C3600	BLA	24" (61 cm) Replacement Blade for FG9C3200	24" l x 0.25" w x 2" h	3.6 lb	61 cm x 0.6 cm x 5.1 cm	1.6 kg	6
FG9C3700	BLA	36" (91.4 cm) Replacement Blade for FG9C3300	36" l x 0.25" w x 2" h	5.2 lb	91.4 cm x 0.6 cm x 5.1 cm	2.4 kg	6

*Use with tapered handles; see page 89.

PROFESSIONAL PLASTIC SQUEEGEES

No.	Color	Description	U.S. Dimensions	U.S. Ship Wt/Ctn	Metric Dimensions	Metric Ship Wt/Ctn	Pack
FG9C4100*	BLA	18" (45.7 cm) Plastic Professional Squeegee with Black Dual Moss Rubber	18" l x 2.3" w x 3.5" h	6.0 lb	45.7 cm x 5.8 cm x 8.9 cm	2.7 kg	10
FG9C4200*	BLA	18" (45.7 cm) Plastic Scrub and Dry Squeegee with Black Dual Moss Rubber	18" l x 2.3" w x 3.5" h	7.0 lb	45.7 cm x 5.8 cm x 8.9 cm	3.2 kg	10
FG9C4300*	RED	18" (45.7 cm) Plastic Professional Squeegee with Red Dual Moss Neoprene	18" l x 2.3" w x 3.5" h	6.0 lb	45.7 cm x 5.8 cm x 8.9 cm	2.7 kg	10
FG9C4400*	RED	18" (45.7 cm) Plastic Scrub and Dry Squeegee with Red Dual Moss Neoprene	18" l x 2.3" w x 3.5" h	7.0 lb	45.7 cm x 5.8 cm x 8.9 cm	3.2 kg	10

*Use with threaded handles; see page 89.

HANDLES FOR ALL OF THESE SQUEEGEES CAN BE FOUND ON PAGE 89.

Lobby Pro® Upright Dust Pans

Stylish pan design.

- Durable rear wheels improve wear resistance and extend product life
- Self-opening and closing lid (on FG253200 and FG253300) conceals unsightly dirt and debris
- Adjustable handle grip enhances user comfort (standard on FG253300)
- Bracket and brooms sold separately



Hanger bracket mounts to BRUTE® container for easy transport.



No.	Color	Description	U.S. Dimensions	U.S. Ship Wt/Ctn	Metric Dimensions	Metric Ship Wt/Ctn	Pack
New! ES FG253100	BLA	Executive Series™ Lobby Pro® Upright Dust Pan	12.8" l x 11.3" w x 5" h	13.0 lb	32.5 cm x 28.7 cm x 12.7 cm	5.9 kg	6
New! ES FG253200	BLA	Executive Series™ Lobby Pro® Upright Dust Pan with Cover	12.8" l x 11.3" w x 5" h	13.0 lb	32.5 cm x 28.7 cm x 12.7 cm	5.9 kg	6
New! ES FG253300	BLA	Lobby Pro® Deluxe Upright Dust Pan with Cover and Adjustable Handle Grip	12.8" l x 11.3" w x 5" h	16.3 lb	32.5 cm x 28.7 cm x 12.7 cm	7.4 kg	6
FG253400	BLA	Lobby Pro® Upright Dust Pan Adjustable Handle Grip	11.5" l x 6" w x 1.75" h	2.4 lb	29.2 cm x 15.2 cm x 4.4 cm	1.1 kg	6
FG253500	BLA	Lobby Pro® Upright Dust Pan Hanger Bracket	4" l x 1.25" w x 1.25" h	0.6 lb	10.2 cm x 3.2 cm x 3.2 cm	0.3 kg	6

ACCESSORIES

No.	Color	Description	U.S. Dimensions	U.S. Ship Wt/Ctn	Metric Dimensions	Metric Ship Wt/Ctn	Pack
New! ES FG253600	BLA	Executive Series™ Lobby Broom, Synthetic Fill	7" l x 37.5" h	2.0 lb	17.8 cm x 95.3 cm	0.9 kg	12
New! ES FG637300	BRN	Lobby Broom, 100% Corn Fill	8" l x 1.5" w x 38" h	10.0 lb	20.3 cm x 3.8 cm x 96.5 cm	4.5 kg	12
New! ES FG637400	BLA	Executive Series™ Lobby Broom, Polypropylene Fill	7.5" l x 2" w x 35" h	6.6 lb	19.1 cm x 5.1 cm x 88.9 cm	3 kg	6

Lobby Pro® Wet/Dry Spill Pan

Quick, safe, and easy cleanup of wet or dry spills.

- Cleaning wand handle allows wide area cleaning without bending
- Soft, natural double-moss blade conforms to uneven surfaces, leaving floors virtually dry to the touch
- Yoke attaches outside pan to help keep hinges free of debris
- Indented footrest lets worker hold pan in place and use two hands while cleaning
- Recessed area contains up to 70.4 oz (2 L) of liquid
- Smooth interior surface for easy cleaning and reduced dirt buildup

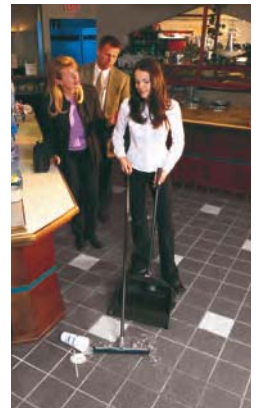
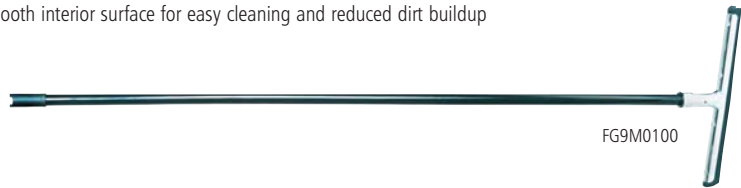

No.	Color	Description	U.S. Dimensions	U.S. Ship Wt/Ctn	Metric Dimensions	Metric Ship Wt/Ctn	Pack
FG9M0000	BLA	Lobby Pro® Wet/Dry Spill Pan	16.5" l x 13.9" w x 39" h	14.0 lb	41.9 cm x 35.3 cm x 99.1 cm	6.4 kg	4
FG9M0100	BLA	Lobby Pro® Wet/Dry Cleaning Wand	13.5" l x 1.9" w x 50" h	5.0 lb	34.3 cm x 4.8 cm x 127 cm	2.3 kg	4
FG253500	BLA	Lobby Pro® Upright Dust Pan Hanger Bracket	4" l x 1.25" w x 1.25" h	0.6 lb	10.2 cm x 3.2 cm x 3.2 cm	0.3 kg	6

WHEN ORDERING PRODUCTS WITH **BOLD** COLOR CODES, PLEASE SPECIFY COLOR CODE AFTER THE PRODUCT NUMBER. REFER TO THE PRODUCT COLOR GUIDE AT THE BACK OF THE CATALOG.



Check out the items marked with this symbol for our new line of Executive Series™ products.



**EXECUTIVE
SERIES™**

SMART DESIGN. TRUSTED EXPERIENCE.

Executive Series™ Cleaning Carts

A complete system solution for cleaning high-profile areas. Executive Series™ carts include the features found in standard versions of the carts on the following pages, plus:

- Distinguished and discreet color scheme
- Super-quiet 4" casters with 8" ball-bearing wheels
- Durable easy-to-clean construction
- Bag covers for discreet trash removal



1861427 Executive Series™ Janitorial Cleaning Cart, High-Security

The new High-Security Janitorial Cart keeps supplies locked securely and discreetly out of sight from guests. Quiet casters and ball-bearing wheels are standard on all Executive Series™ janitorial carts, allowing cleaning staff to work unobtrusively throughout your facility.



1861428 Executive Series™ Janitorial Cleaning Cart w/ Bins, High-Capacity

Our new compact High-Capacity Janitorial Cleaning Cart includes waste cover lids, removable caddies, and storage bins to keep supplies concealed from view while allowing easy access for restocking.



1861429 Executive Series™ Janitorial Cleaning Cart, High-Capacity

The Executive Series™ High-Capacity Janitorial Cart is a great step up from your traditional janitor's cart. With 40% more storage and a wide range of available accessories, it can be set up to support the needs of any cleaning staff.





1861441 Executive Series™ Janitorial Cleaning and Recycling Cart, High-Capacity

Discreetly collect more than twice as much waste as before with the new Janitorial Cleaning and Recycling Cart. Waste cover lids keep trash out of sight from guests, while removable caddies and bins speed cart restocking before each shift.

	No.	Color	Description	U.S. Dimensions	U.S. Ship Wt/Ctn	Metric Dimensions	Metric Ship Wt/Ctn	Pack
New!	ES 1861427	BLACK	Executive Series™ Janitorial Cleaning Cart, High-Security	48.25" l x 22" w x 53.5" h	70.0 lb	122.6 cm x 55.9 cm x 135.9 cm	31.8 kg	1
New!	ES 1861428	BLACK	Executive Series™ Janitorial Cleaning Cart w/ Bins, High-Capacity	48.25" l x 22" w x 44" h	53.0 lb	122.6 cm x 55.9 cm x 111.8 cm	24 kg	1
New!	ES 1861429	BLACK	Executive Series™ Janitorial Cleaning Cart, High-Capacity	49.75" l x 21.75" w x 38.38" h	45.0 lb	126.4 cm x 55.2 cm x 97.5 cm	20.4 kg	1
New!	ES 1861441	BLACK	Executive Series™ Janitorial Cleaning and Recycling Cart, High-Capacity	51.75" l x 22" w x 44" h	66.4 lb	131.4 cm x 55.9 cm x 111.8 cm	30.1 kg	1
New!	ES 1851454	BLACK	High-Capacity Vinyl Replacement Bag	33" l x 10.5" w x 17.5" h	6.2 lb	83.8 cm x 26.7 cm x 44.5 cm	2.8 kg	2

Traditional Janitorial
Cleaning CartsWaste/Recycling
Cleaning Carts

	Features	Traditional Janitorial Cleaning Carts		Waste/Recycling Cleaning Carts	
		FG617388	1861430 	FG9T7900	1861441 
Cart Features	Storage Capacity (cu. ft.)	5	5	7.25	7.25
	Durable, Easy-to-Clean, Rust-Resistant Aluminum and Plastic Construction (Aluminum and Structural Web)	Yes	Yes	Yes	Yes
	4" Casters	Std.	Quiet	Std.	Quiet
	8" Wheels	Std.	Quiet	Std.	Quiet (ball-bearing)
	Rubber Tool Grip and Vacuum Holders (qty.)	N/A	N/A	2	2
	Standard Tool Grip and Vacuum Holders (qty.)	11	11	N/A	N/A
	Safety Sign Hooks (qty.)	2	2	4	4
	Comfort-Grip Handle	Yes	Yes	Yes	Yes
Bags	Mop Bucket Platform with Securing Grooves and Lock 'N Go Connection	N/A	N/A	Yes	Yes
	Waste/Recycling Bag Capacity	34 Gal.	34 Gal.	34 Gal.	34 Gal.
	ZippeRed, Leak-Proof Bag for Easy Trash Removal	Yes	Yes	Yes	Yes
Pails, Caddies, Bins	Covers/Lids for Bags	<i>Optional</i>	Yes	<i>Optional</i>	Yes
	30-Qt. Storage Bins	N/A	N/A	<i>Optional</i>	N/A
	10-Qt. Carry Caddies	2 Yellow	2 Black	2 Yellow	2 Black
	5-Qt. Pails	N/A	N/A	<i>Optional</i>	<i>Optional</i>
Storage	Locking Cabinet Doors	<i>Optional</i>	Yes	<i>Optional</i>	N/A
	Side Panels to Conceal Cleaning Supplies	N/A	Yes	N/A	Yes
	Hood	N/A	N/A	<i>Optional</i>	<i>Optional</i>
Other	Joint Commission-Compliant (Environment of Care Std. 3.10.3)	N/A	N/A	N/A	N/A

WHEN ORDERING PRODUCTS WITH **BOLD** COLOR CODES,
PLEASE SPECIFY COLOR CODE AFTER THE PRODUCT NUMBER.
REFER TO THE PRODUCT COLOR GUIDE AT THE BACK OF THE CATALOG.





Check out the items marked with this symbol for our new line of Executive Series™ products.

High-Capacity Janitorial Cleaning Carts

High-Security Janitorial Cleaning Carts



	FG9T7400	FG9T7300	 1861428	FG9T7200	 1861429		FG9T7500	 1861427
	7.25	7.25	7.25	7.25	7.25		7.25	7.25
	Yes	Yes	Yes	Yes	Yes		Yes	Yes
	Std.	Std.	Quiet	Std.	Quiet		Std.	Quiet
	Std.	Std.	Quiet (ball-bearing)	Std.	Quiet (ball-bearing)		Std.	Quiet (ball-bearing)
	5 N/A	5 N/A	5 N/A	5 N/A	5 N/A		5 N/A	5 N/A
	4	4	4	4	4		4	4
	Yes	Yes	Yes	Yes	Yes		Yes	Yes
	Yes	Yes	Yes	Yes	Yes		Yes	Yes
	34 Gal.	34 Gal.	34 Gal.	34 Gal.	34 Gal.		34 Gal.	34 Gal.
	Yes	Yes	Yes	Yes	Yes		Yes	Yes
	Yes	Optional	Yes	Optional	Yes		Yes	Yes
	2 Yellow	2 Yellow	2 Black	Optional	2 Black		Optional	Optional
	Optional	2 Yellow	1 Black	2 Yellow	2 Black		2 Yellow	2 Black
	1 Ea. Blue, Red, Yellow, Green	Optional	1 Black, 1 Gray	Optional	Optional		Optional	Optional
	Optional	Optional	Optional	Optional	Optional		Yes	Yes
	Optional	Optional	Yes	Optional	Yes		Yes	Yes
	Optional	Optional	Optional	Optional	Optional		Yes	Yes
	N/A	N/A	N/A	N/A	N/A		Yes	Yes

Cart Features

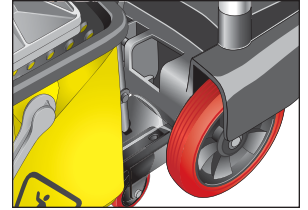

QUIET CASTERS AND WHEELS

Rubbermaid's red Quiet Casters and new enhanced wheels last 200% longer and roll smoother to ensure a smooth and quiet operation.

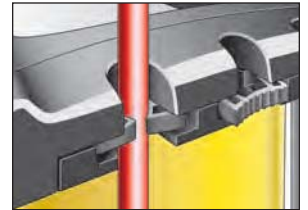

SECURE MOP AND BROOM STORAGE

Innovative rubber Tool Grips hold handles at any position, up to 1 1/2" in diameter.

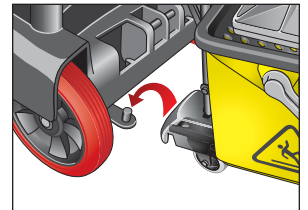

LOCK 'N GO CONNECTION

This innovative locking system keeps various Microfiber Buckets, or WaveBrake® FG768000 and FG767700 Mop Buckets securely attached to the cart.

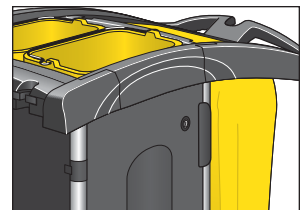

ADD A LOCKING DOOR KIT

Optional FG9T8500 Locking Cabinet Door Kit provides added security (see *Cleaning and Housekeeping Cart Accessories*).

See it in ACTION

www.rubbermaidcleaningcarts.com

1800 750 900

Rubbermaid
Commercial Products

High-Capacity Janitorial Cleaning Carts with Bins

Multifunctional system that is great for microfiber or standard cleaning

- Flexible and adjustable to fit your needs
- Removable 30-qt. bins and 10-qt. caddies
- Locking grooves for mop buckets or microfiber charging system
- Available components vary in color, size, and function to fit your specific needs (see *Cleaning and Housekeeping Cart Accessories*)



ADD A LOCKING DOOR KIT

Optional FG9T8500 Locking Cabinet Door Kit provides added security (see *Cleaning and Housekeeping Cart Accessories*).



FG9T7400 includes four swivel casters and four color-coded 5-quart Disinfecting Pails.



FG9T7300



ES 1861428

No.	Color	Description	U.S. Dimensions	U.S. Ship Wt/Ctn	Metric Dimensions	Metric Ship Wt/Ctn	Pack
FG9T7300	BLA	Microfiber Cleaning Cart	48.25" l x 22" w x 44" h	53.0 lb	122.6 cm x 55.9 cm x 111.8 cm	24 kg	1
1861428	BLA	Executive Series™ Janitorial Cleaning Cart w/ Bins, High-Capacity	48.25" l x 22" w x 44" h	53.0 lb	122.6 cm x 55.9 cm x 111.8 cm	24 kg	1
FG9T7400	BLA	Microfiber Cleaning Cart with Color-Coded Pails	48.25" l x 22" w x 44" h	53.0 lb	122.6 cm x 55.9 cm x 111.8 cm	24 kg	1
FG9T7301	0000	Lock 'N Go Accessory	N/A	.75 lb	N/A	.3 kg	1

High-Security Janitorial Cleaning Cart

A complete system solution for cleaning your facility.

- Doors supply a discreet and secure area for cleaning supplies
- Removable 10-quart Carry Caddies hold up to 6 spray bottles or up to 25 microfiber cloths
- Multifunctional cleaning carts are microfiber or standard cleaning systems-capable
- Helps meet Joint Commission standards (Environment of Care Standard 3.10.3)
- Available components vary in color, size, and function to fit your specific needs (see *Cleaning and Housekeeping Cart Accessories*)



ADD WASTE COVER AND STORAGE COMPARTMENT

Provides waste coverage and offers functional storage for personal items.

PREASSEMBLED LOCKING SECURITY HOOD

Speeds up assembly and ensures all products will be secure



FG9T7500 with FG768000 WaveBrake® Dual-Water Side-Press Combo in Lock 'N Go position.



ES 1861427

No.	Color	Description	U.S. Dimensions	U.S. Ship Wt/Ctn	Metric Dimensions	Metric Ship Wt/Ctn	Pack
FG9T7500	BLA	High-Security Cleaning Cart	48.25" l x 22" w x 53.5" h	70.0 lb	122.6 cm x 55.9 cm x 135.9 cm	31.8 kg	1
1861427	BLA	Executive Series™ Janitorial Cleaning Cart, High-Security	48.25" l x 22" w x 53.5" h	70.0 lb	122.6 cm x 55.9 cm x 135.9 cm	31.8 kg	1
FG9T7301	0000	Lock 'N Go Accessory	N/A	0.8 lb	N/A	0.4 kg	1

WHEN ORDERING PRODUCTS WITH BOLD COLOR CODES, PLEASE SPECIFY COLOR CODE AFTER THE PRODUCT NUMBER. REFER TO THE PRODUCT COLOR GUIDE AT THE BACK OF THE CATALOG.



Check out the items marked with this symbol for our new line of Executive Series™ products.

High-Capacity Janitorial Cleaning Carts

Flexible, high-capacity storage solutions and tool organization.

- 5 cu ft of storage space and 20% more waste capacity than FG617388
- Rubber Tool Grips hold up to 5 stick goods in back
- Comfort Grip cart handle for easy maneuverability
- Hooks hold up to four Safety Signs
- Available components vary in color, size, and function to fit your specific needs (see *Cleaning and Housekeeping Cart Accessories*)

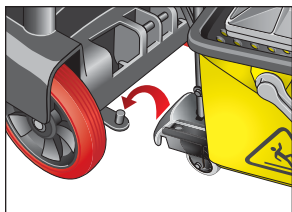

LOCK 'N GO ACCESSORY

This innovative locking system keeps various Microfiber Buckets, or WaveBrake® FG768000 and FG767700 Mop Buckets securely attached to the cart.

FG9T7200



FG9T7900



ES 1861429

No.	Color	Description	U.S. Dimensions	U.S. Ship Wt/Ctn	Metric Dimensions	Metric Ship Wt/Ctn	Pack
New! ES FG9T7200	BLA	High-Capacity Cleaning Cart	49.75" l x 21.75" w x 38.38" h	45.0 lb	126.4 cm x 55.2 cm x 97.5 cm	20.4 kg	1
1861429	BLACK	Executive Series™ Janitorial Cleaning Cart, High-Capacity	49.75" l x 21.75" w x 38.38" h	45.0 lb	126.4 cm x 55.2 cm x 97.5 cm	20.4 kg	1
New! ES FG9T7900	BLA	Double-Capacity Cleaning Cart	51.75" l x 22" w x 44" h	66.4 lb	131.4 cm x 55.9 cm x 111.8 cm	30.1 kg	1
1861441	BLACK	Executive Series™ Janitorial Cleaning and Recycling Cart, High-Capacity	51.75" l x 22" w x 44" h	66.4 lb	131.4 cm x 55.9 cm x 111.8 cm	30.1 kg	1
FG9T7301	0000	Lock 'N Go Accessory	N/A	0.8 lb	N/A	0.4 kg	1

Traditional Janitorial Cleaning Carts

Collect waste and transport tools for efficient cleaning.

- Smooth, easy-to-clean surface
- Zippered bag for easy trash removal
- Front platform holds mop bucket or up to a 32-gallon BRUTE® container
- Optional Locking Cabinet Doors, Quiet Casters, and Recycling bags



ADD LOCKING CABINET DOORS

Help keep cleaning supplies hidden and secure.



ADD WASTE COVER AND STORAGE COMPARTMENT

Provides waste coverage and offers functional storage for personal items.

FG617388



ES 1861430

No.	Color	Description	U.S. Dimensions	U.S. Ship Wt/Ctn	Metric Dimensions	Metric Ship Wt/Ctn	Pack
New! ES FG617388	BLA	Cleaning Cart with Zippered Yellow Vinyl Bag	46" l x 21.75" w x 38.38" h	49.5 lb	116.8 cm x 55.2 cm x 97.5 cm	22.5 kg	1
1861430	BLACK	Executive Series™ Janitorial Cleaning Cart, Standard	46" l x 21.75" w x 38.38" h	49.5 lb	116.8 cm x 55.2 cm x 97.5 cm	22.5 kg	1
New! ES FG618300	YEL	Vinyl Replacement Bag with Zipper for FG617388 Cleaning Cart	17.25" l x 10.50" w x 30.50" h	3.46 lb	43.8 cm x 26.7 cm x 77.5 cm	1.57 kg	2
1861442	BLACK	Vinyl Replacement Bag with Zipper for 1861430 Cleaning Cart	17.25" l x 10.50" w x 30.50" h	3.46 lb	43.8 cm x 26.7 cm x 77.5 cm	1.57 kg	2
New! ES FG618100	YEL	Locking Cabinet Doors	20" l x 16" w x 11.25" h	7.83 lb	50.8 cm x 40.6 cm x 28.6 cm	3.55 kg	1
1861443	BLACK	Executive Series™ Locking Cabinet Doors	20" l x 16" w x 11.25" h	7.83 lb	50.8 cm x 40.6 cm x 28.6 cm	3.55 kg	1
FG617900	BLA	Storage Compartment/Trash Cover	17.63" l x 12.5" w x 2.38" h	3.0 lb	44.8 cm x 31.8 cm x 6 cm	1.4 kg	1

Three-Compartment Carts

Maximize productivity and help reduce labor costs with the Three-Compartment Carts.

Configure them for recycling or for linen collection.

Use with the colored recycling bags to create a multistream collection for efficient, cost-effective sortation.

Customizable options support recycling and green cleaning.

- High-capacity zippered bags hold up to 34 gallons each (total of 12 bushels)
- Available in Red, Green, and Blue vinyl with universal recycling symbol, Yellow vinyl for general waste, or Black fabric for linen collection (bags sold separately)
- Rubber Tool Grips hold handles upright
- Nonrusting, easy-to-clean aluminum and durable structural web plastic construction
- 4" swivel casters and new enhanced superior 8" wheels
- Flexible and adjustable to fit your needs
- Available components vary in color, size, and function to fit your specific needs see *Cleaning and Housekeeping Cart Accessories*

See it in ACTION
www.rubbermaidcleaningcarts.com



VERSATILE STORAGE OPTIONS
 Organize and store supplies and tools with removable caddies and other accessories (sold separately).

EASY TO MAINTAIN
 using genuine Rubbermaid Commercial parts.

SECURE VACUUM AND BROOM STORAGE
 Both handles include rubber Tool Grips that hold handles up to 1½" in diameter, including commercial upright vacuums.

COMFORT GRIP CART HANDLE
 Improved design makes the cart more maneuverable and comfortable.

HIGH-CAPACITY FABRIC BAG
 Fabric bags hold up to 34 gallons each, reducing the frequency of trips to empty filled bags. Zippered front access makes removing soiled linens easier. (Bags sold separately.)



FG9T9200 Triple-Capacity Cart shown with optional FG9T9300 Recycling Bags and FG253300 Lobby Pro® Deluxe Upright Dust Pan and Broom (see pg. 94).

FG9T9200 Triple Capacity Cart shown with optional FG9T8100 Compact Fabric Bags (see pg. 102).



FG9T9300 Recycling Bags with Universal Recycling Symbol.



FG9T8901 Triple, FG616200 Dual, and FG616300 Single Wire bag holders allow for further sortation within each vinyl bag. Works with all FG9T7200–FG9T9500 Carts.



FG9T9200 Triple-Capacity Cart with three FG9T8000 High-Capacity Vinyl Bags.

No.	Color	Description	U.S. Dimensions	U.S. Ship Wt/Ctn	Metric Dimensions	Metric Ship Wt/Ctn	Pack
FG9T9200	BLA	Triple-Capacity Cleaning Cart	51.75" l x 22" w x 44" h	40.5 lb	131.4 cm x 55.9 cm x 111.8 cm	18.4 kg	1
FG9T9301	0000	Recycling Bag with Universal Recycling Symbol, Set of 3 Colors (Red, Green, Blue)	33" l x 10.5" w x 17.5" h	7.2 lb	83.8 cm x 26.7 cm x 44.5 cm	3.3 kg	1
FG9T9300	RED, GRN, BLUE	Recycling Bag with Universal Recycling Symbol	33" l x 10.5" w x 17.5" h	7.2 lb	83.8 cm x 26.7 cm x 44.5 cm	3.3 kg	3
FG9T8000	YEL	High-Capacity Vinyl Replacement Bag	33" l x 10.5" w x 17.5" h	6.2 lb	83.8 cm x 26.7 cm x 44.5 cm	2.8 kg	2
FG9T8100	BLA	Compact Fabric Replacement Bag	33" l x 10.5" w x 17.5" h	6.2 lb	83.8 cm x 26.7 cm x 44.5 cm	2.8 kg	2

WHEN ORDERING PRODUCTS WITH BOLD COLOR CODES, PLEASE SPECIFY COLOR CODE AFTER THE PRODUCT NUMBER. REFER TO THE PRODUCT COLOR GUIDE AT THE BACK OF THE CATALOG.



Check out the items marked with this symbol for our new line of Executive Series™ products.

Deluxe Wood-Paneled Carts

Housekeeping carts with upscale features and appearance.

- High-end styling—black and mahogany color scheme
- Chemical- and water-resistant finish
- High capacity-to-footprint ratio; only 22" wide
- Quiet ball-bearing wheels
- Upgraded locks on both doors



Faux wood finish.



ES FG9T9400



ES FG9T9500

ELEGANT WOODGRAIN FINISH
Provides elegant, upscale appearance ideal for front-of-house applications.

8" WHEELS WITH BALL BEARINGS
8" wheels with ball bearings, combined with 4" Quiet casters offer smooth, quiet movement.

No.	Color	Description	U.S. Dimensions	U.S. Ship Wt/Ctn	Metric Dimensions	Metric Ship Wt/Ctn	Pack
New! ES	FG9T9400BLA WOODGRAIN	Executive Series™ Deluxe Paneled Compact Housekeeping Cart	38.25" l x 22" w x 44" h	66.0 lb	97.2 cm x 55.9 cm x 111.8 cm	29.9 kg	1
New! ES	FG9T9500BLA WOODGRAIN	Executive Series™ Deluxe Paneled Housekeeping Cart	51.75" l x 22" w x 53.5" h	79.0 lb	131.4 cm x 55.9 cm x 135.9 cm	35.8 kg	1
	FG9T9600 MAHG	Deluxe Paneled Housekeeping Cart Locking Cabinet Door Kit	33.25" l x 16" w x 3" h	16.0 lb	84.5 cm x 40.6 cm x 7.6 cm	7.3 kg	1

Compact Housekeeping Carts

Ergonomic and lightweight housekeeping solutions.

- High capacity-to-footprint ratio; only 22" wide
- Multiple accessories available for a customized solution

FG9T7600 Compact Folding Housekeeping Cart

- 28% more compact when folded up
- 37% more compact footprint folded up than our standard size FG618900
- Locking cabinet doors on both sides of cart
- One heavy-duty zippered Compact Fabric Bag, with waterproof PVC lining

FG9T7800 High-Security Cart

- Includes locking security hood and cabinet doors, with access from both sides of cart
- 32% more compact size than our FG9T1900 Hooded Cart
- Two heavy-duty zippered Compact Fabric Bags with waterproof PVC lining

FG9T7700 Turndown Cart

- Includes Locking Cabinet Doors and one Compact Fabric Bag

EASY TO MAINTAIN
using genuine Rubbermaid Commercial parts.
See Component Parts.



ES FG9T7800 shown with optional FG9T9000 9-Pocket Fabric Organizer and FG9T9101 Fabric Mesh Linen Bag (see page. 102).



ES FG9T7600 Handles and platform fold for easier storage.



ES FG9T7700

See it in ACTION
www.rubbermaidcleaningcarts.com

No.	Color	Description	U.S. Dimensions	U.S. Ship Wt/Ctn	Metric Dimensions	Metric Ship Wt/Ctn	Pack
New! ES	FG9T7600 BLA	Executive Series™ Compact Folding Housekeeping Cart	51.75" l x 22" w x 44" h	74.0 lb	131.4 cm x 55.9 cm x 111.8 cm	33.6 kg	1
New! ES	FG9T7700 BLA	Executive Series™ Turndown Housekeeping Cart	38.25" l x 22" w x 44" h	66.0 lb	97.2 cm x 55.9 cm x 111.8 cm	29.9 kg	1
New! ES	FG9T7800 BLA	Executive Series™ High-Security Housekeeping Cart	51.75" l x 22" w x 53.5" h	79.0 lb	131.4 cm x 55.9 cm x 135.9 cm	35.8 kg	1

Cleaning, Deluxe Panelled, and Compact Housekeeping Cart Accessories

Improve workflow and increase productivity.*

FABRIC BAG (34 GAL)



FG9T8100

VINYL BAG (34 GAL)



FG9T8000

RECYCLING BAGS 3-COLOR SET (34 GAL)



FG9T9301

TRIPLE WASTE WIRE BAG DIVIDER



FG9T8901

BAGS AND BAG HOLDERS

No.	Color	Description	U.S. Dimensions	U.S. Ship Wt/Ctn	Metric Dimensions	Metric Ship Wt/Ctn	Pack
FG9T8000	YEL	High-Capacity Vinyl Replacement Bag – 34 gallon	33" l x 10.5" w x 17.5" h	6.2 lb	83.8 cm x 26.7 cm x 44.5 cm	2.8 kg	2
New! 1851454	BLACK	High-Capacity Vinyl Replacement Bag	33" l x 10.5" w x 17.5" h	6.2 lb	83.8 cm x 26.7 cm x 44.5 cm	2.8 kg	2
New! FG9T8100	BLA	Compact Fabric Replacement Bag	33" l x 10.5" w x 17.5" h	6.2 lb	83.8 cm x 26.7 cm x 44.5 cm	2.8 kg	2
New! FG9T9101	BLA	Fabric Mesh Linen Bag	33" l x 10.5" w x 16.88" h	10.9 lb	83.8 cm x 26.7 cm x 42.9 cm	4.9 kg	6
FG9T9301	0000	Recycling Bag with Universal Recycling Symbol, Set of 3 Colors (Red, Green, Blue)	33" l x 10.5" w x 17.5" h	7.2 lb	83.8 cm x 26.7 cm x 44.5 cm	3.3 kg	1
FG9T9300	RED, GRN, BLUE	Recycling Bag with Universal Recycling Symbol	33" l x 10.5" w x 17.5" h	7.2 lb	83.8 cm x 26.7 cm x 44.5 cm	3.3 kg	3
New! FG9T9000	BLA	9-Pocket Fabric Organizer	28" l x 19.75" w x 1.5" h	7.3 lb	71.1 cm x 50.2 cm x 3.8 cm	3.3 kg	6
FG616200	0000	Dual Waste Wire Bag Holders	12.5" l x 3" w x 0.13" h	2.5 lb	31.8 cm x 7.6 cm x 0.3 cm	1.1 kg	6
FG616300	0000	Single Waste Wire Bag Holder	20" l x 16" w x 11.25" h	7.8 lb	50.8 cm x 40.6 cm x 28.6 cm	3.5 kg	6
FG9T8901	0000	Triple Waste Wire Bag Holders	12.5" l x 3" w x 0.13" h	2.5 lb	31.8 cm x 7.6 cm x 0.3 cm	1.1 kg	1

*Compatible with all Cleaning Carts, pages 98–106 (excluding FG617388 on page 99).

10-QT. CADDIES



FG9T8200

5-QT. PAILS



FG9T8301*

*Now available in 7 colors

30-QT. BINS, YELLOW



FG9T8400

30-QT. BINS, BLACK



FG9T8400

PAILS, CADDIES, AND BINS

No.	Color	Description	U.S. Dimensions	U.S. Ship Wt/Ctn	Metric Dimensions	Metric Ship Wt/Ctn	Pack
New! FG9T8200	BLA	10-Quart Sanitizing Caddy	7.5" l x 14" w x 8" h	10.0 lb	19.1 cm x 35.6 cm x 20.3 cm	4.5 kg	6
FG9T8301		4-Pack of 5-Quart Disinfecting Pails – Blue, Red, Yellow, Green	7.5" l x 9.25" w x 8.5" h	6.0 lb	19.1 cm x 23.5 cm x 21.6 cm	2.7 kg	1
1857376	BLUE	5-Quart Disinfecting Pail – Blue	7.5" l x 9.25" w x 8.5" h	6.0 lb	19.1 cm x 23.5 cm x 21.6 cm	2.7 kg	4
1857375	RED	5-Quart Disinfecting Pail – Red	7.5" l x 9.25" w x 8.5" h	6.0 lb	19.1 cm x 23.5 cm x 21.6 cm	2.7 kg	4
1857374	YELLOW	5-Quart Disinfecting Pail – Yellow	7.5" l x 9.25" w x 8.5" h	6.0 lb	19.1 cm x 23.5 cm x 21.6 cm	2.7 kg	4
1857377	GREEN	5-Quart Disinfecting Pail – Green	7.5" l x 9.25" w x 8.5" h	6.0 lb	19.1 cm x 23.5 cm x 21.6 cm	2.7 kg	4
New! 1857378	BLACK	5-Quart Disinfecting Pail – Black	7.5" l x 9.25" w x 8.5" h	6.0 lb	19.1 cm x 23.5 cm x 21.6 cm	2.7 kg	4
New! 1857380	GRAY	5-Quart Disinfecting Pail – Gray	7.5" l x 9.25" w x 8.5" h	6.0 lb	19.1 cm x 23.5 cm x 21.6 cm	2.7 kg	4
1857379	WHITE	5-Quart Disinfecting Pail – White	7.5" l x 9.25" w x 8.5" h	6.0 lb	19.1 cm x 23.5 cm x 21.6 cm	2.7 kg	4
New! FG9T8400	YEL, BLA	30-Quart Organizing Bins	11" l x 17.5" w x 14" h	7.0 lb	27.9 cm x 44.5 cm x 35.6 cm	3.2 kg	2

*Compatible with all Cleaning Carts, pages 98–106 (excluding FG617388 on page 99).

WHEN ORDERING PRODUCTS WITH **BOLD** COLOR CODES,
PLEASE SPECIFY COLOR CODE AFTER THE PRODUCT NUMBER.
REFER TO THE PRODUCT COLOR GUIDE AT THE BACK OF THE CATALOG.



Check out the items marked with this symbol for our new line of Executive Series™ products.

LOCKING CABINET DOOR KITS



FG9T8100

LOCKING DOOR KIT



FG9T8500

LOCKING SECURITY HOOD



FG9T8600

TRASH COVERS



FG617900

STORAGE KITS AND CASTERS

No.	Color	Description	U.S. Dimensions	U.S. Ship Wt/Ctn	Metric Dimensions	Metric Ship Wt/Ctn	Pack
New! ⑤ FG9T8500	BLA	Locking Cabinet Door Kit	33" l x 16" w x 1" h	16.0 lb	83.8 cm x 40.6 cm x 2.5 cm	7.3 kg	1
FG618100	YEL	Locking Cabinet Doors	20" l x 16" w x 11.25" h	7.83 lb	50.8 cm x 40.6 cm x 28.6 cm	3.6 kg	1
New! ⑤ FG9T9600	MAHG	Deluxe Paneled Housekeeping Cart Locking Cabinet Door Kit	33.25" l x 16" w x 3" h	16.0 lb	84.5 cm x 40.6 cm x 7.6 cm	7.3 kg	1
New! ⑤ FG9T8600	BLA	Preassembled Locking Security Hood	9.5" l x 17" w x 19" h	8.0 lb	24.1 cm x 43.2 cm x 48.3 cm	3.6 kg	1
New! ⑤ FG617900	BLA	Storage Compartment/Trash Cover	17.63" l x 12.5" w x 2.38" h	3.0 lb	44.8 cm x 31.8 cm x 6 cm	1.4 kg	1
1868991	BLA	Trash Cover	17.63" l x 12.5" w x 2.38" h	3.0 lb	44.8 cm x 31.8 cm x 6 cm	1.4 kg	1
FG9T8701	RED	4" Quiet Caster Kit (2)	7" l x 4.5" w x 2" h	6.0 lb	20.3 cm x 7.6 cm x 20.3 cm	2.7 kg	1

*Compatible with all Cleaning Carts, pages 98–106 (excluding FG617388 on page 99).

SLIM JIM® CONTAINER



FG354060GRAY

SLIM JIM® RECYCLING CONTAINER



FG354007BLUE

BRUTE® 44-GALLON CONTAINER



FG264360BLA

BRUTE® 32-GALLON CONTAINER



FG264360GRAY

SLIM JIM® AND BRUTE® CONTAINERS

No.	Color	Description	U.S. Dimensions	U.S. Ship Wt/Ctn	Metric Dimensions	Metric Ship Wt/Ctn	Pack
New! ⑤ FG354060	GRAY, BLA, BEIG	Slim Jim® with Venting Channels	22" l x 11" w x 30" h	30.6 lb	55.9 cm x 27.9 cm x 76.2 cm	13.9 kg	4
FG354007	GRN, BLUE	Slim Jim® with Venting Channels – Recycling	22" l x 11" w x 30" h	30.6 lb	55.9 cm x 27.9 cm x 76.2 cm	13.9 kg	4
FG263200	YEL, WHT, RED, GRAY, DGRN, BLUE	BRUTE® 32-Gallon Container	22" dia x 27.25" h	49.5 lb	55.9 cm dia x 69.2 cm	22.5 kg	6
New! ⑤ FG264360	YEL, RED, GRAY, BLUE, BLA	BRUTE® 44-Gallon Utility Container with Venting Channels	24" dia x 31.5" h	49.5 lb	61 cm dia x 80 cm	22.5 kg	4

For more options, see *Utility and Recycling Refuse*.

Metal Housekeeping Carts

New expanded capacity, customizable accessories, and ergonomic design save you time and money.

- Durable baked-on, powder-coated finish improves durability and resists scratches and fingerprints
- Bumpers help protect walls and furniture (standard on FG9T5900, FG9T6100, FG9T6300, and FG9T6400 carts)
- Features a 25° bend comfort-grip handle for easier pushing and steering
- Extra capacity available; carts can hold up to three 34-gallon (4 bushels) fabric bags
- Includes ball-bearing, nonmarking 8" casters
- Accessories available to fit your needs

 **30%** Post-Consumer Recycled Steel



FG617400 Mobile Bag 34 gallons (4 bushels)



■ **PROTECTIVE HOOD**
26% more storage area and improved visibility for user.

■ **LOCKING DRAWER**
Protects and organizes room amenities.

■ **FABRIC BAG**
Zippered access and 34-gallon (4 bushels) capacity.

■ **VACUUM HOLDER**
Securely holds most commercial vacuums.

■ **OPTIONAL GLASS RACK HOLDER**
Accommodates glass racks up to 8" high.

■ **OPTIONAL FABRIC MESH LINEN BAG**

■ **RUGGED NYLON MOBILE FABRIC BAG**
34-gallon (4 bushels) fabric bag for efficient collection and transport of soiled linens and waste.

EASY TO MAINTAIN
Using genuine Rubbermaid Commercial parts.

 **FG9T6400 DELUXE HIGH-SECURITY HOUSEKEEPING CART**

CUSTOM COLORS AVAILABLE

Order 50 or more of the same SKU of Metal Housekeeping Carts in any one of more than 200 custom colors.

Uni-Koat® Arch Bronze

Uni-Koat® Desert Pearl

Uni-Koat® Beige

Uni-Koat® Brown

Uni-Koat® Anth

Uni-Koat® Almond

WHEN ORDERING PRODUCTS WITH BOLD COLOR CODES, PLEASE SPECIFY COLOR CODE AFTER THE PRODUCT NUMBER. REFER TO THE PRODUCT COLOR GUIDE AT THE BACK OF THE CATALOG.



Check out the items marked with this symbol for our new line of Executive Series™ products.

ES **FG9T6000 COMPACT HOUSEKEEPING CART**
Most compact cart in the line. Two-shelf linen cabinet holds 7.3 ft³ of supplies.



ES **FG9T6200 HIGH-CAPACITY HOUSEKEEPING CART**
Two-shelf linen cabinet provides 9 ft³ of storage.



ES **FG9T5900 CRUISE HOUSEKEEPING CART**
Three-shelf linen cabinet provides 10.2 ft³ of storage. Fits through narrow hallways (19" width vs. standard 20"-24" cart widths).



ES **FG9T6100 DELUXE COMPACT HOUSEKEEPING CART**
Perfect turnaround cart. Three-shelf cabinet holds 8.8 ft³.



ES **FG9T6300 DELUXE HIGH-CAPACITY HOUSEKEEPING CART**
Three-shelf linen cabinet holds 11 ft³ of supplies.



ES **FG9T6400 DELUXE HIGH-SECURITY HOUSEKEEPING CART**
Three-shelf linen cabinet provides 11 ft³ of storage. Lockable top compartment provides added security and storage.



	No.	Color	Description	U.S. Dimensions	U.S. Capacity	U.S. Ship Wt/Ctn	Metric Dimensions	Metric Capacity	Metric Ship Wt/Ctn	Pack
New!	ES	BLA	Executive Series™ Cruise Housekeeping Cart	55" l x 19" w x 50" h	10.2 cu ft	85.0 lb	139.7 cm x 48.3 cm x 127 cm	.29 m ³	38.6 kg	1
New!	ES	BLA	Executive Series™ Compact Housekeeping Cart	49" l x 22" w x 44" h	7.3 cu ft	63.0 lb	124.5 cm x 55.9 cm x 111.8 cm	.21 m ³	28.6 kg	1
New!	ES	BLA	Executive Series™ Deluxe Compact Housekeeping Cart	49" l x 22" w x 50" h	8.8 cu ft	71.0 lb	124.5 cm x 55.9 cm x 127 cm	.25 m ³	32.2 kg	1
New!	ES	BLA	Executive Series™ High-Capacity Housekeeping Cart	55" l x 22" w x 44" h	9.0 cu ft	80.0 lb	139.7 cm x 55.9 cm x 111.8 cm	.26 m ³	36.3 kg	1
New!	ES	BLA	Executive Series™ Deluxe High-Capacity Housekeeping Cart	55" l x 22" w x 50" h	11 cu ft	89.0 lb	139.7 cm x 55.9 cm x 127 cm	.31 m ³	40.4 kg	1
New!	ES	BLA	Deluxe High-Security Housekeeping Cart	55" l x 22" w x 56" h	15.3 cu ft	121.0 lb	139.7 cm x 55.9 cm x 142.2 cm	.43 m ³	54.9 kg	1
New!	ES	BLA	Deluxe Housekeeping Cart with Locking Drawer	55" l x 22" w x 56" h	15.3 cu ft	121.0 lb	139.7 cm x 55.9 cm x 142.2 cm	.43 m ³	54.9 kg	1

* Vacuum bungees not included.

Metal Housekeeping Cart Accessories

Improve workflow and increase productivity.

PROTECTIVE HOOD



FG616700



GLASS RACK



FG617100



EASY SIDE-LOAD LINEN BAG



FG9T9101

Also works with 6191, 6192, 9T19, 9T67, 9T77, 9T78, 9T94, and 9T95 carts



LOCKING DOORS



FG617000



MOBILE BAG



FG617400



	No.	Color	Description	U.S. Dimensions	U.S. Ship Wt/Ctn	Metric Dimensions	Metric Ship Wt/Ctn	Pack
New!	ES	BLA	Mobile Fabric Bag	11" l x 18.5" w x 35" h	11.5 lb	27.9 cm x 47 cm x 88.9 cm	5.2 kg	1
New!	ES	BLA	Fabric Divided Bag	10" l x 17.5" w x 33" h	3.5 lb	25.4 cm x 44.5 cm x 83.8 cm	1.6 kg	2
New!	ES	BLA	Fabric Literature Organizer	0.25" l x 10.5" w x 28" h	3.2 lb	0.6 cm x 26.7 cm x 71.1 cm	1.5 kg	6
New!	ES	BLA	Compact Fabric Replacement Bag	33" l x 10.5" w x 17.5" h	6.2 lb	83.8 cm x 26.7 cm x 44.5 cm	2.8 kg	2
New!	ES	BLA	Heavy-Duty Fabric Bag – Medium	10" l x 17.5" w x 26.5" h	2.9 lb	25.4 cm x 44.5 cm x 67.3 cm	1.3 kg	2
New!	ES	BLA	Heavy-Duty Fabric Bag – Long	10" l x 17.5" w x 33" h	3.2 lb	25.4 cm x 44.5 cm x 83.8 cm	1.5 kg	2
New!	ES	BLA	Protective Hood	39" l x 19" w x 12.5" h	24.0 lb	99.1 cm x 48.3 cm x 31.8 cm	10.9 kg	1
New!	ES	BLA	Easy Side-Load Linen Bag	33" l x 10.5" w x 16.88" h	10.9 lb	83.8 cm x 26.7 cm x 42.9 cm	4.9 kg	6
New!	ES	BLA	Locking Door Kit	0.75" l x 28" w x 32.5" h	19.5 lb	1.9 cm x 71.1 cm x 82.6 cm	8.8 kg	1
	ES	BLA	Under-Deck Glass Rack Holder	20" l x 20" w x 8.25" h	12.0 lb	50.8 cm x 50.8 cm x 21 cm	5.4 kg	1

Classic Housekeeping Carts

A complete system solution for housekeeping in the hospitality industry.

- Commercial-grade molded construction
- Easy-to-clean surfaces and molded-in color
- Nonmarking wheels
- Standard equipment includes vinyl bag, bumpers, vacuum holder, and under-deck shelf
- Available with or without doors or hood
- Full-size cabinet offers exceptional storage space and adjustable middle shelf
- Fully-rounded, user-friendly handles are easy to grip and assist maneuverability
- Optional accessories enhance functionality and productivity



FG618900



ES FG619100

■ **DOORS SUPPLY DISCREET AND SECURE AREA FOR CLEANING SUPPLIES**

■ **MESH FABRIC LINEN BAG**
Allows quick and easy access to linens.

EASY TO MAINTAIN
using genuine Rubbermaid Commercial parts. See Component Parts.



ES FG9T1900

■ **PROTECTIVE HOOD**
Helps hide soaps and cleaning supplies from guests.

■ **MULTIPLE FABRIC BAG OPTIONS**
Rubbermaid offers a variety of fabric bags that allows the user to order the bags that will best fit their needs.



ES FG619200

No.	Color	Description	U.S. Dimensions	U.S. Ship Wt/Ctn	Metric Dimensions	Metric Ship Wt/Ctn	Pack
New! ES	PLAT, BLA	Executive Series™ Full-Size Housekeeping Cart	60" l x 22" w x 50" h	102.1 lb	152.4 cm x 55.9 cm x 127 cm	46.3 kg	1
New! ES	BLA	Executive Series™ Compact Housekeeping Cart	49" l x 22" w x 50" h	95.6 lb	124.5 cm x 55.9 cm x 127 cm	43.4 kg	1
New! ES	BLA	Executive Series™ Full-Size Housekeeping Cart with Doors	60" l x 22" w x 50" h	108.8 lb	152.4 cm x 55.9 cm x 127 cm	49.4 kg	1
New! ES	BLA	Executive Series™ Compact Housekeeping Cart with Doors	49" l x 22" w x 50" h	102.3 lb	124.5 cm x 55.9 cm x 127 cm	46.4 kg	1
New! ES	BLA	Executive Series™ Full-Size Housekeeping Cart with Doors	60" l x 22" w x 67.5" h	126.3 lb	152.4 cm x 55.9 cm x 171.5 cm	57.3 kg	1

WHEN ORDERING PRODUCTS WITH **BOLD** COLOR CODES, PLEASE SPECIFY COLOR CODE AFTER THE PRODUCT NUMBER. REFER TO THE PRODUCT COLOR GUIDE AT THE BACK OF THE CATALOG.



Check out the items marked with this symbol for our new line of Executive Series™ products.

HEAVY-DUTY CANVAS BAG



FG9T0400



COMPACT FABRIC BAG (34 GAL)



FG9T8100



9 POCKET ORGANIZER



FG9T9000



MESH LINEN BAG



FG9T9000



BAGS

	No.	Color	Description (All product numbers begin with FG)	U.S. Dimensions	U.S. Ship Wt/Ctn	Metric Dimensions	Metric Ship Wt/Ctn	Pack
New!	ES	BRN	Executive Series™ Canvas Linen Accessory Bag for 618900, 619000, 619100, 619200, 9T1900 Carts	33" l x 10.5" w x 16.8" h	7.9 lb	83.8 cm x 26.7 cm x 42.7 cm	3.6 kg	6
New!	ES	BLA	9-Pocket Fabric Organizer	28" l x 19.75" w x 1.5" h	7.3 lb	71.1 cm x 50.2 cm x 3.8 cm	3.3 kg	6
New!	ES	BLA	Fabric Mesh Linen Bag	33" l x 10.5" w x 16.88" h	10.9 lb	83.8 cm x 26.7 cm x 42.9 cm	4.9 kg	6
New!	ES	BLACK	High Capacity Vinyl Replacement Bag	33" l x 10.5" w x 17.5" h	6.2 lb	83.8 cm x 26.7 cm x 44.5 cm	2.8 kg	2
New!	ES	BLA	Compact Fabric Replacement Bag	33" l x 10.5" w x 17.5" h	6.2 lb	83.8 cm x 26.7 cm x 44.5 cm	2.8 kg	2

Classic Housekeeping Cart Accessories

PROTECTIVE HOOD



FG9T0000



REFUSE COVER FOR BAGS



1837785



ADJUSTABLE SHELF KIT



FG335388

LOCKING DRAWER



FG619900

ACCESSORIES

	No.	Color	Description (All product numbers begin with FG)	U.S. Dimensions	U.S. Ship Wt/Ctn	Metric Dimensions	Metric Ship Wt/Ctn	Pack
New!	ES	BLA	Refuse Bin	12" l x 17" w x 22" h	9.0 lb	30.5 cm x 43.2 cm x 55.9 cm	4.1 kg	2
New!	ES	BLA	Utility Bin	12.13" l x 17" w x 10.5" h	5.4 lb	30.8 cm x 43.2 cm x 26.7 cm	2.4 kg	2
New!	ES	PLAT, BLA	Adjustable Shelf Kit for Classic Housekeeping Carts	30.13" l x 18.5" w x 2.25" h	5.0 lb	76.5 cm x 47 cm x 5.7 cm	2.3 kg	1
New!	ES	PLAT, BLA	Glass Rack for Classic Housekeeping Carts	25.38" l x 21" w x 6.7" h	2.5 lb	64.5 cm x 53.3 cm x 17 cm	1.1 kg	1
New!	ES	BRN, BLA	Locking Door Kit for Classic Housekeeping Carts	34" l x 1.88" w x 31.63" h	6.7 lb	86.4 cm x 4.8 cm x 80.3 cm	3 kg	1
New!	ES	BRN, BLA	Utility Drawer with Lock	N/A	4.5 lb	N/A	2 kg	1
New!	ES	PLAT, BLA	Protective Security Hood for Classic Housekeeping Carts	31.63" l x 20.38" w x 17.5" h	21.5 lb	80.3 cm x 51.8 cm x 44.5 cm	9.8 kg	1
New!	ES	BLACK	Refuse Cover for 618900, 619000, 619100, 619200, 9T1900 Carts	12.28" l x 18.53" w x 0.5" h	1.7 lb	31.2 cm x 47.1 cm x 1.3 cm	0.8 kg	1

SMARTER VACUUMS. SLEEK, NEW DESIGN.



EXECUTIVE
SERIES™

WHEN ORDERING PRODUCTS WITH **BOLD** COLOR CODES,
PLEASE SPECIFY COLOR CODE AFTER THE PRODUCT NUMBER.
REFER TO THE PRODUCT COLOR GUIDE AT THE BACK OF THE CATALOG.



Check out the items marked with this symbol for
our new line of Executive Series™ products.

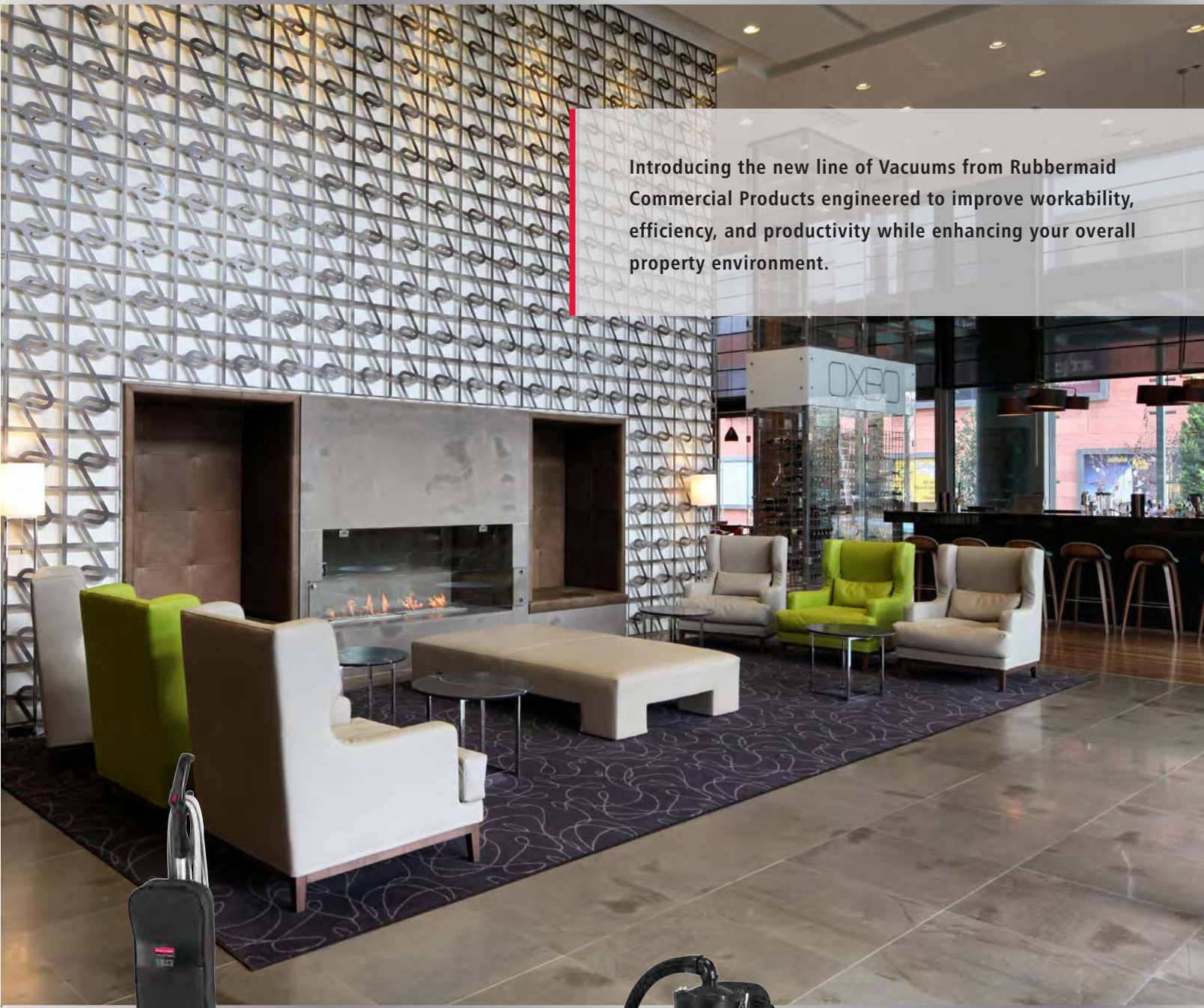

Introducing the new line of Vacuums from Rubbermaid Commercial Products engineered to improve workability, efficiency, and productivity while enhancing your overall property environment.



Our Ultra Lightweight Vacuum is ideal for areas with stairways and small spaces. The ergonomic handle design allows the user to transport the unit with ease. Outboard wheels make it easy to maneuver.



Our Backpack Vacuums clean quietly and efficiently while easily maneuvering around obstacles. Innovative comfort-fit harness keeps motor and heat away from the body while promoting airflow for a more comfortable use.

Commercial Backpack Vacuum Cleaners **New!**

Easy to maneuver and designed for comfort.

- 1.3 HP vacuum motor, 110 CFM airflow, 100" water lift
- Noise Level: 66 dBA (BP06), 66.9 dBA (BP10), 65.8 dBA (BH10)
- Onboard attachments
- Four-stage filtration for improved indoor air quality
- Integrated HEPA filtration system (FG9VBH10/1868435)
- LEED point-qualified
- Closed bag system with secure top latches
- Lightweight with a narrow profile for easy mobility
- Ergonomically designed harness with padded hip and shoulder belts
- No tools required for assembly



See it in ACTION

www.rubbermaidvacuums.com



FG9BPHA06 – BACKPACK HARNESS
Superior ergonomic design enhances productivity and comfort.



No.	Color	Description	U.S. Dimensions	U.S. Ship Wt/Ctn	Metric Dimensions	Metric Ship Wt/Ctn	Pack
FG9VBP06	0000	6-Qt Capacity Backpack Vacuum Cleaner	11.5" l x 13" w x 21.1" h	22.2 lb	29.2 cm x 33 cm x 53.6 cm	10.1 kg	1
New! ES 1868433	BLACK	6-Qt Capacity Executive Series™ Backpack Vacuum Cleaner	11.5" l x 13" w x 21.1" h	22.2 lb	29.2 cm x 33 cm x 53.6 cm	10.1 kg	1
FG9VBP10	0000	10-Qt Capacity Backpack Vacuum Cleaner	11.5" l x 13" w x 24.8" h	22.9 lb	29.2 cm x 33 cm x 63 cm	10.4 kg	1
New! ES 1868434	BLACK	10-Qt Capacity Executive Series™ Backpack Vacuum Cleaner	11.5" l x 13" w x 24.8" h	22.9 lb	29.2 cm x 33 cm x 63 cm	10.4 kg	1
FG9VBH10	0000	10-Qt Capacity HEPA Backpack Vacuum Cleaner	11.5" l x 13" w x 27.6" h	24.7 lb	29.2 cm x 33 cm x 70.1 cm	11.2 kg	1
New! ES 1868435	BLACK	10-Qt Capacity Executive Series™ HEPA Backpack Vacuum Cleaner	11.5" l x 13" w x 27.6" h	24.7 lb	29.2 cm x 33 cm x 70.1 cm	11.2 kg	1

WHEN ORDERING PRODUCTS WITH **BOLD** COLOR CODES, PLEASE SPECIFY COLOR CODE AFTER THE PRODUCT NUMBER. REFER TO THE PRODUCT COLOR GUIDE AT THE BACK OF THE CATALOG.



Check out the items marked with this symbol for our new line of Executive Series™ products.

PAPER BAG



FG9VBPP06

FILTER CLOTH BAG



FG9VBPA06

HEPA PAPER BAG



FG9VBPH06

HEPA FILTER



FG9VBHHP10

EXHAUST FILTER



FG9VBPEF06

COMMERCIAL BACKPACK VACUUM CLEANER REPLACEMENT BAGS AND FILTERS

No.	Color	Description	U.S. Dimensions	U.S. Ship Wt/Ctn	Metric Dimensions	Metric Ship Wt/Ctn	Pack
FG9VBPP06		Replacement Paper Bag for FG9VB06 and 1868433	12.7" l x 7.9" w x 0.2" h	7.2 lb	32.3 cm x 20.1 cm x 0.5 cm	3.3 kg	10
FG9VBPA06		Replacement Cloth Bag for FG9VB06 and 1868433	10.6" l x 10.6" w x 0.6" h	3.0 lb	26.9 cm x 26.9 cm x 1.5 cm	1.4 kg	10
FG9VBPA10		Replacement Cloth Bag for FG9VB10, 1868434, FG9VBH10, and 1868435	7.5" l x 7.5" w x 15" h	4.4 lb	19.1 cm x 19.1 cm x 38.1 cm	2 kg	10
FG9VBPPB10		Replacement Paper Bag for FG9VB10, 1868434, FG9VBH10, and 1868435	7.7" l x 7.7" w x 19.3" h	3.2 lb	19.6 cm x 19.6 cm x 49 cm	1.5 kg	10
FG9VBPH06		HEPA Bag for FG9VB06 and 1868433	12.7" l x 7.9" w x 0.2" h	1.4 lb	32.3 cm x 20.1 cm x 0.5 cm	0.6 kg	6
FG9VBHHP10		Replacement HEPA Exhaust Filter for FG9VBH10 and 1868435	9.4" l x 9.5" w x 5.1" h	3.4 lb	23.9 cm x 24.1 cm x 13 cm	1.5 kg	5
1871881		Replacement HEPA Intake Filter for Backpack Vacuum					
FG9VBPEF06		Replacement Exhaust Filter with Sound Diffuser and Foam Intake Filter for FG9VB06, 1868433, FG9VB10 and 1868434	8.3" l x 8.3" w x 1.8" h	3.0 lb	21.1 cm x 21.1 cm x 4.6 cm	1.4 kg	10

HARD FLOOR TOOL



FG9VBPFT06

HOSE



FG9VBPH06

BELT EXTENDER



FG9VBPEB06

POWER CORD - YELLOW



1868623

POWER CORD - GRAY



1871788

COMMERCIAL BACKPACK VACUUM CLEANER ACCESSORIES

No.	Color	Description	U.S. Dimensions	U.S. Ship Wt/Ctn	Metric Dimensions	Metric Ship Wt/Ctn	Pack
FG9VBPEB06		Belt Extender for Backpack Vacuum	29.75" l x 0.15" w x 4.1" h	4.7 lb	75.6 cm x 0.4 cm x 10.4 cm	2.1 kg	10
FG9VBPH06		Replacement Backpack Harness for Backpack Vacuum	13.2" l x 3.9" w x 24" h	23.6 lb	33.5 cm x 9.9 cm x 61 cm	10.7 kg	6
FG9VBPHS06		Replacement Cleaner Hose for Backpack Vacuum	3.7" l x 3.7" w x 17.7" h	10.7 lb	9.4 cm x 9.4 cm x 45 cm	4.9 kg	10
1868623	YEL	Replacement Power Cord for FG9VB06, FG9VB10, FG9VBH10	10" l x 10" w x 4" h				1
1871788	GRAY	Replacement Power Cord for 1868433, 1868434, 1868435	10" l x 10" w x 4" h				1
1871791		Replacement Tool Connection Adapter for Backpack Vacuum					5
1871792		Replacement 12" Crevice Tool for Backpack Vacuum					5
1871793		Replacement 5" Upholstery Tool for Backpack Vacuum					5
1871894		Replacement 3" Brush Assembly for Backpack Vacuum					5
1871895		Hard Floor Nozzle for Backpack Vacuum					5

New!

Manual-Height Upright Vacuum Cleaners

Durable vacuum that provides superior filtration.

- 1.6 HP vacuum motor, 105 CFM airflow, 98" water lift
- Noise level: 67.4 dBA (MH12), 68.2 dBA (MH15)
- 4-position carpet-height adjustment
- Onboard attachments
- HEPA bags and filters are available (optional)
- LEED point-qualified
- Bag full/clogged sensors
- Brush roll jam sensor
- Heavy-duty 40-ft (12-m) detachable power cord, available in yellow and gray
- No tools required for assembly



New!



- **QUICK CONNECT POWER CORD**
Includes a 40' heavy-duty detachable extension cord.
- **EASY TO EMPTY**
Highly efficient filtration bags are easy to remove and replace. Optional HEPA Filtration Kit is also available (FG9VMHHP).
- **INTELLIGENT MAINTENANCE INDICATORS**
Includes full bag, brush jam, and end-of-brush-life indicators.
- **EASY CLOG REMOVAL**
Be back to work in minutes, with easy-access clog removal for the lower hose.
- **FINGERTIP CONTROL**
Easy-to-reach on/off control for safety and convenience.
- **EASY SERVICING**
Agitator can be removed for service with the push of a button.
- **HEIGHT ADJUSTMENT CONTROL DIAL**
Allows for easy height adjustment with four height options.
- **BRUSH ROLL RELEASE**
Easy brush roll removal.



No.	Color	Description (All product numbers begin with FG)	U.S. Dimensions	U.S. Ship Wt/Ctn	Metric Dimensions	Metric Ship Wt/Ctn	Pack
FG9VMH12	0000	12" Manual-Height Upright Vacuum Cleaner	12.6" l x 12" w x 46" h	24.0 lb	32 cm x 30.5 cm x 116.8 cm	10.9 kg	1
New! ES 1868440	BLACK	12" Executive Series™ Manual-Height Upright Vacuum Cleaner	12.6" l x 12" w x 46" h	24.0 lb	32 cm x 30.5 cm x 116.8 cm	10.9 kg	1
FG9VMH15	0000	15" Manual-Height Upright Vacuum Cleaner	12.6" l x 15" w x 46" h	25.0 lb	32 cm x 38.1 cm x 116.8 cm	11.3 kg	1
New! ES 1868621	BLACK	15" Executive Series™ Manual-Height Upright Vacuum Cleaner	12.6" l x 15" w x 46" h	25.0 lb	32 cm x 38.1 cm x 116.8 cm	11.3 kg	1

Dual-Motor Power-Height Upright Vacuum Cleaners

Maximum performance and extended product life.

- 1.8 Total HP dual-motor system, 105 CFM airflow, 98" water lift
- Noise level: 67.3 dBA (PH12), 67.7 dBA (PH15)
- Automatic carpet-height adjustment
- Onboard attachments
- HEPA bags and filters (optional)
- LEED point-qualified
- Indicator lights to monitor optimal performance
- Heavy-duty 40-ft (12-m) detachable power cord, available in yellow and gray
- No tools required for assembly



New!



- **COMFORT-GRIP HANDLE**
Ergonomic design for ease of use and maneuverability.
- **EASY TO EMPTY**
Highly efficient filtration bags are easy to remove and replace. Optional HEPA Filtration Kit is also available (FG9VMHHP).
- **INTELLIGENT MAINTENANCE INDICATORS**
Includes full bag, brush jam, nozzle height adjustment (up and down) and end-of-brush-life indicators.
- **SOFT TREADED WHEELS**
3" wheels make maneuvering easy.
- **MULTI-STAGE FILTRATION**
Designed for improved indoor air quality.
- **FLAT-TO-FLOOR POSITIONING**
Made for cleaning under furniture.
- **AUTOMATIC HEIGHT ADJUSTMENT**
Optimizes cleaning performance while eliminating the need to stop and set vacuum height for different floor heights.



No.	Color	Description (All product numbers begin with FG)	U.S. Dimensions	U.S. Ship Wt/Ctn	Metric Dimensions	Metric Ship Wt/Ctn	Pack
FG9VPH12	0000	12" Power-Height Upright Vacuum Cleaner	13.8" l x 12" w x 46" h	27.0 lb	35.1 cm x 30.5 cm x 116.8 cm	12.2 kg	1
New! ES 1868438	BLACK	12" Executive Series™ Power-Height Upright Vacuum Cleaner	13.8" l x 12" w x 46" h	27.0 lb	35.1 cm x 30.5 cm x 116.8 cm	12.2 kg	1
FG9VPH15	0000	15" Power-Height Upright Vacuum Cleaner	13.8" l x 15" w x 46" h	28.0 lb	35.1 cm x 38.1 cm x 116.8 cm	12.7 kg	1
New! ES 1868439	BLACK	15" Executive Series™ Power-Height Upright Vacuum Cleaner	13.8" l x 15" w x 46" h	28.0 lb	35.1 cm x 38.1 cm x 116.8 cm	12.7 kg	1

WHEN ORDERING PRODUCTS WITH **BOLD** COLOR CODES, PLEASE SPECIFY COLOR CODE AFTER THE PRODUCT NUMBER. REFER TO THE PRODUCT COLOR GUIDE AT THE BACK OF THE CATALOG.



Check out the items marked with this symbol for our new line of Executive Series™ products.

Traditional Upright Vacuum Cleaners **New!**

Versatile commercial vacuum cleaners.

- 1.13 HP vacuum motor, 156.5 CFM airflow, 100" water lift
- Noise level: 75.9 dBA (CV12), 76.8 dBA (CV16)
- 6-position carpet height adjustment
- Large outboard wheels for easy maneuvering
- Easy-empty cloth bag; paper bag standard
- Heavy-duty 40-ft (12-m) detachable power cord, available in yellow and gray
- Agitator easily removable for service (no tools required)



See it in ACTION
www.rubbermaidvacuums.com



**Yellow Models
 Soon To Be Discontinued!**

FG9VCV12 FG9VCV16



- **DURABLE, LONG LIFE**
 Designed with a metal tube handle and bottom handle for superior durability.
- **IMPROVED FILTRATION**
 Collection bag is contained within a cloth exterior bag resulting in improved air quality.
- **FLAT-TO-FLOOR**
 Makes vacuuming under beds and furniture easy.
- **40-FT. POWER CORD**
 Provides a longer reach without switching outlets.
- **TOP-FILL BAGS**
 Helps prevent clogs and improve motor life.
- **HEIGHT ADJUSTMENT CONTROL DIAL**
 Allows for easy height adjustment with six height options.

No.	Color	Description	U.S. Dimensions	U.S. Ship Wt/Ctn	Metric Dimensions	Metric Ship Wt/Ctn	Pack
FG9VCV12	0000	12" Traditional Upright Vacuum Cleaner	16.5" l x 13.1" w x 46.1" h	20.2 lb	41.9 cm x 33.3 cm x 117.1 cm	9.2 kg	1
New! ES 1868436	BLACK	12" Executive Series™ Traditional Upright Vacuum Cleaner	16.5" l x 13.1" w x 46.1" h	20.2 lb	41.9 cm x 33.3 cm x 117.1 cm	9.2 kg	1
FG9VCV16	0000	16" Traditional Upright Vacuum Cleaner	16.5" l x 17.4" w x 46.1" h	21.1 lb	41.9 cm x 44.2 cm x 117.1 cm	9.6 kg	1
New! ES 1868437	BLACK	16" Executive Series™ Traditional Upright Vacuum Cleaner	16.5" l x 17.4" w x 46.1" h	21.1 lb	41.9 cm x 44.2 cm x 117.1 cm	9.6 kg	1

Ultra-Light Upright Vacuum Cleaners **New!**

Lightweight vacuum with superior suction.

- 0.65 HP vacuum motor, 79.5 CFM airflow, 100" water lift
- Noise level: 70.5 dBA
- Floating nozzle for hard and soft floor surfaces
- Large outboard wheels for easy maneuvering
- Center-balanced "easy carry" handle makes lifting and carrying simple
- No tools required for assembly

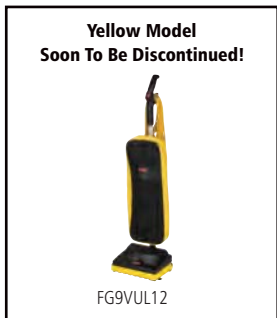

**Yellow Model
 Soon To Be Discontinued!**

FG9VUL12



- **EASY-CARRY HANDLE**
 Makes lifting and carrying simple.
- **SUPERIOR DESIGN**
 Unique extension cord hook keeps the power cord securely attached to the extension cord.
- **FLAT TO FLOOR**
 Makes vacuuming under beds and furniture easy.
- **LIGHTWEIGHT**
 Weighs only 9.7 pounds.
- **EASY TO EMPTY**
 Makes cleaning easier and more efficient.
- **FLOATING NOZZLE**
 Enables cleaning of both hard and soft floor surfaces.

No.	Color	Description	U.S. Dimensions	U.S. Ship Wt/Ctn	Metric Dimensions	Metric Ship Wt/Ctn	Pack
FG9VUL12	0000	12" Ultra-Light Upright Vacuum Cleaner	9.4" l x 12.5" w x 46.4" h	15.5 lb	23.9 cm x 31.8 cm x 117.9 cm	7 kg	1
New! ES 1868622	BLACK	12" Executive Series™ Ultra-Light Upright Vacuum Cleaner	9.4" l x 12.5" w x 46.4" h	15.5 lb	23.9 cm x 31.8 cm x 117.9 cm	7 kg	1

Replacement and Maintenance Parts for Upright Vacuum Cleaners

5.63-QT. PAPER BAG



FG9VMHBA12

HEPA BAG AND FILTER KIT



FGVMHHP

STEEL BRUSH ROLL



FG9VCVBR12

DUAL-MOTOR POWER-HEIGHT UPRIGHT VACUUMS

No.	Color	Description	U.S. Dimensions	U.S. Ship Wt/Ctn	Metric Dimensions	Metric Ship Wt/Ctn	Pack
FG9VMHBA12		Replacement Paper Bag for Dual-Motor and Manual-Height Upright Vacuums	16.3" l x 5.1" w x 0.6" h	8.3 lb	41.4 cm x 13 cm x 1.5 cm	3.8 kg	10
FG9VMHHP		HEPA Filter Kit for FG9VPH12, 1868438, FG9VPH15, 1868439, FG9VMH12, 1868440, FG9VMH15, and 1868621 (8 bags and 1 filter)	7.7" l x 3.2" w x 16" h	6.9 lb	19.6 cm x 8.1 cm x 40.6 cm	3.1 kg	6
FG9VMHMF12		Replacement Air Filter for FG9VPH12, 1868438, FG9VPH15, 1868439, FG9VMH12, 1868440, FG9VMH15, and 1868621	2.3" l x 2.3" w x 16" h	3.9 lb	5.8 cm x 5.8 cm x 40.6 cm	1.8 kg	10
FG9VPHF12		Replacement Exhaust Filter for FG9VPH12, 1868438, FG9VPH15, and 1868439	3" l x 0.4" w x 4.5" h	0.5 lb	7.6 cm x 1 cm x 11.4 cm	0.2 kg	10
FG9VPHBE12		Replacement Timing Belt for FG9VPH12, 1868438, FG9VPH15, and 1868439	3.5" l x 3.5" w x 0.3" h	1.0 lb	8.9 cm x 8.9 cm x 0.8 cm	0.5 kg	6
FG9VPHBR12		Replacement Brush Roll for FG9VPH12 and 1868438	2.6" l x 2.6" w x 11" h	7.4 lb	6.6 cm x 6.6 cm x 27.9 cm	3.4 kg	10
FG9VPHBR15		Replacement Brush Roll for FG9VPH15 and 1868439	2.6" l x 2.6" w x 14" h	9.7 lb	6.6 cm x 6.6 cm x 35.6 cm	4.4 kg	10

MANUAL-HEIGHT UPRIGHT VACUUMS

No.	Color	Description	U.S. Dimensions	U.S. Ship Wt/Ctn	Metric Dimensions	Metric Ship Wt/Ctn	Pack
FG9VMHBA12		Replacement Paper Bag for FG9VPH12, 1868438, FG9VPH15, 1868439, FG9VMH12, 1868440, FG9VMH15, and 1868621	16.3" l x 5.1" w x 0.6" h	8.3 lb	41.4 cm x 13 cm x 1.5 cm	3.8 kg	10
FG9VMHHP		HEPA Filter Kit for FG9VPH12, 1868438, FG9VPH15, 1868439, FG9VMH12, 1868440, FG9VMH15, and 1868621 (8 bags and 1 filter)	7.7" l x 3.2" w x 16" h	6.9 lb	19.6 cm x 8.1 cm x 40.6 cm	3.1 kg	6
FG9VMHMF12		Replacement Air Filter for FG9VPH12, 1868438, FG9VPH15, 1868439, FG9VMH12, 1868440, FG9VMH15, and 1868621	2.3" l x 2.3" w x 16" h	3.9 lb	5.8 cm x 5.8 cm x 40.6 cm	1.8 kg	10
FG9VMHEF12		Replacement Exhaust Filter for FG9VMH12, 1868440, FG9VMH15, and 1868621	3" l x 0.4" w x 3.7" h	0.4 lb	7.6 cm x 1 cm x 9.4 cm	0.2 kg	10
FG9VMHBE12		Replacement Brush Belt for FG9VMH12, 1868440, FG9VMH15, and 1868621	3.1" l x 3.1" w x 0.3" h	0.8 lb	7.9 cm x 7.9 cm x 0.8 cm	0.4 kg	6
FG9VMHBL12		Replacement Motor Belt for FG9VMH12, 1868440, FG9VMH15, and 1868621	3.5" l x 3.5" w x 0.3" h	1.0 lb	8.9 cm x 8.9 cm x 0.8 cm	0.5 kg	6
FG9VMHBR12		Replacement Brush Roll for FG9VMH12 and 1868440	2.6" l x 2.6" w x 11" h	7.4 lb	6.6 cm x 6.6 cm x 27.9 cm	3.4 kg	10
FG9VMHBR15		Replacement Brush Roll for FG9VMH15 and 1868621	2.6" l x 2.6" w x 14" h	9.7 lb	6.6 cm x 6.6 cm x 35.6 cm	4.4 kg	10

TRADITIONAL UPRIGHT VACUUMS

No.	Color	Description	U.S. Dimensions	U.S. Ship Wt/Ctn	Metric Dimensions	Metric Ship Wt/Ctn	Pack
FG9VCVPB12		Replacement Paper Bag for FG9VCV12, 1868436, FG9VCV16, and 1868437	22.8" l x 9.3" w x 0.2" h	12.7 lb	57.9 cm x 23.6 cm x 0.5 cm	5.8 kg	10
FG9VCVBA12		Replacement Cloth Dust Bag with Dust Tube for FG9VCV12, 1868436, FG9VCV16, and 1868437	27.8" l x 8.1" w x 3.2" h	7.8 lb	70.6 cm x 20.6 cm x 8.1 cm	3.5 kg	8
FG9VCVSB12		Shake-Out Bags for FG9VCV12, 1868436, FG9VCV16, 1868437	22" l x 8.1" w x 3.1" h	7.8 lb	55.9 cm x 20.6 cm x 7.9 cm	3.5 kg	8
FG9VCVBE12		Replacement Round Belt for FG9VCV12, 1868436, FG9VCV16, and 1868437	4.1" l x 4.1" w x 0.3" h	0.6 lb	10.4 cm x 10.4 cm x 0.8 cm	0.3 kg	10
FG9VCVBR12		Replacement Brush Roll for FG9VCV12 and 1868436	2.2" l x 2.2" w x 12.4" h	10.5 lb	5.6 cm x 5.6 cm x 31.5 cm	4.8 kg	10
FG9VCVBR16		Replacement Brush Roll for FG9VCV16 and 1868437	2.2" l x 2.2" w x 15.6" h	13.3 lb	5.6 cm x 5.6 cm x 39.6 cm	6 kg	10

ULTRA-LIGHT UPRIGHT VACUUMS

No.	Color	Description	U.S. Dimensions	U.S. Ship Wt/Ctn	Metric Dimensions	Metric Ship Wt/Ctn	Pack
FG9VULPB12		Replacement Paper Bag for FG9VUL12 and 1868622	23.6" l x 7.9" w x 0.3" h	14.1 lb	59.9 cm x 20.1 cm x 0.8 cm	6.4 kg	10
FG9VULBC12		Replacement Cloth Bag for FG9VUL12 and 1868622	26.4" l x 11" w x 1.8" h	4.1 lb	67.1 cm x 27.9 cm x 4.6 cm	1.9 kg	4
FG9VULBE12		Replacement Belt for FG9VUL12 and 1868622	3.1" l x 3.1" w x 0.6" h	1.6 lb	7.9 cm x 7.9 cm x 1.5 cm	0.7 kg	10
FG9VULBR12		Replacement Brush Roll for FG9VUL12 and 1868622	2.2" l x 2.2" w x 10.8" h	9.9 lb	5.6 cm x 5.6 cm x 27.4 cm	4.5 kg	10

WHEN ORDERING PRODUCTS WITH **BOLD** COLOR CODES, PLEASE SPECIFY COLOR CODE AFTER THE PRODUCT NUMBER. REFER TO THE PRODUCT COLOR GUIDE AT THE BACK OF THE CATALOG.



Check out the items marked with this symbol for our new line of Executive Series™ products.

Commercial Wet and Dry Vacuum Cleaners

Powerful and versatile cleaning tool.

- 1.9 HP vacuum motor, 110 CFM, 105" water lift
- Onboard tool storage; tools and cart are included
- HEPA filtration system (optional)
- Exterior switch enables tank selection without opening the vacuum
- Exclusive two-tank system holds dry debris separate from liquids

See it in ACTION
www.rubbermaidvacuums.com



Instant wet-to-dry changeover.

DISCONTINUED!
ORDER WHILE SUPPLIES LAST.

FG9VWD160000

1.9 HP MOTOR
Power to tackle the toughest jobs.

2-TANK SYSTEM
Instant wet-to-dry changeover.

ONBOARD TOOL STORAGE
Tools always on board for quick easy access.

LARGE REAR WHEELS
8" diameter rear wheels are easier to maneuver.

LARGE, LOCK-ON HOSE
12-ft, 1.5" diameter hose.

8-PIECE TOOL KIT
Two stainless steel extensions, floor tool with bristles, floor squeegee, utility nozzle, crevice tool, dusting brush, and floor nozzle.



Compacts for quick and easy transport.

FG9VWD12

No.	Color	Description	U.S. Dimensions	U.S. Ship Wt/Ctn	Metric Dimensions	Metric Ship Wt/Ctn	Pack
FG9VWD12	0000	12.5 Gal Capacity Wet and Dry Vacuum Cleaner	27.6" l x 20.3" w x 35.9" h	60.0 lb	70.1 cm x 51.6 cm x 91.2 cm	27.2 kg	1
FG9VWD16	0000	16 Gal Capacity Wet and Dry Vacuum Cleaner	27.6" l x 20.3" w x 35.9" h	62.0 lb	70.1 cm x 51.6 cm x 91.2 cm	28.1 kg	1
FG9VWDPF12		Replacement HEPA Pleated Filter for FG9VWD12 and FG9VWD16 (with foam sleeves)	7.1" l x 7.1" w x 5.9" h	10.2 lb	18 cm x 18 cm x 15 cm	4.6 kg	10
FG9VWDF12		Replacement Foam Filters for FG9VWD12 and FG9VWD16 (1 large and 1 small)	7.9" l x 5.9" w x 1.6" h	2.4 lb	20.1 cm x 15 cm x 4.1 cm	1.1 kg	50
FG9VWDHS12		Replacement Cleaner Hose for FG9VWD12 and FG9VWD16	15" l x 5.9" w x 15" h	35.8 lb	38.1 cm x 15 cm x 38.1 cm	16.2 kg	10

DVAC 1 Pass Cleaning Solution™

Introducing a revolutionary new concept in cleaning. DVAC 1 Pass Cleaning Solution™ combines multiple cleaning steps into one, eliminating nonproductive labor time to save you money.



DVAC combines vacuuming, cleaning, and waste collection into an efficient, single-pass process, saving up to **66%** of nonproductive travel time.



Deluxe Rim Caddy's organized storage of cleaning supplies makes an extra trip to the supply closet unnecessary.



Holds two can liners for collecting recyclable and general waste, eliminating a separate waste collection pass through an area.



A powerful commercial-grade vacuum is integrated into the dolly to maximize one-pass productivity.



At 65.3 dBA, DVAC 1 Pass Cleaning Solution's™ quiet operation supports day cleaning.

WORK SAFER, WORK SMARTER

DVAC's ergonomically designed arched handle keeps the user's wrist and forearm bones aligned for optimum leverage and maneuverability.

Safer operation with less risk of injury helps reduce worker compensation claims and lost time.

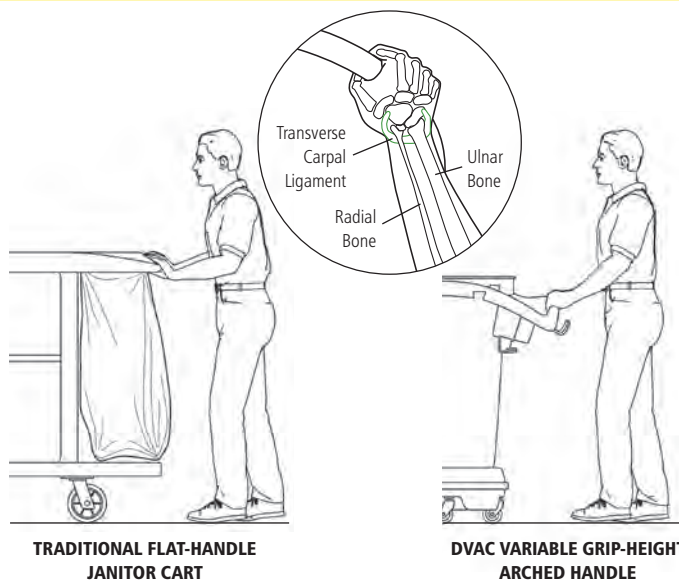

WHEN ORDERING PRODUCTS WITH **BOLD** COLOR CODES, PLEASE SPECIFY COLOR CODE AFTER THE PRODUCT NUMBER. REFER TO THE PRODUCT COLOR GUIDE AT THE BACK OF THE CATALOG.



Check out the items marked with this symbol for our new line of Executive Series™ products.

OPTIMIZE PRODUCTIVITY

Make waste collection more efficient with a vented BRUTE® 44-gallon Utility Container (sold separately).

USE FOR DAY CLEANING

Very quiet operation, perfect for noise-sensitive environments and day cleaning.

PROTECT AIR QUALITY

HEPA bags help protect indoor air quality for greener operation (optional).

CLEAN EFFECTIVELY

Onboard crevice, upholstery, and dusting tools included for high dusting.

WORK EFFICIENTLY

Floor Switch on straight suction model allows user to easily change surface selection from carpet to hard floor.

1.55 HP VACUUM MOTOR, 110 CFM AIRFLOW, 100" WATER LIFT

NOISE LEVEL: 65.3 DBA



SUPPORTS RECYCLING EFFORTS

Holds up to 175 lbs of waste and recycling in two easy-to-install can liners.



STAY ORGANIZED

Deluxe Rim Caddy keeps cleaning tools and supplies within easy reach for 1-pass cleaning.



FG9DVPN4400



Power Nozzle Model only.

POWERFUL DESIGN

Dedicated powered agitator nozzle handles multiple carpet heights and types.

FG9DVPN4400 Shown with accessories, sold separately.



COMMERCIAL-GRADE DURABILITY

Powerful commercial-grade dolly with integrated vacuum.

BRUTE® 44-gallon Utility Container not included.

No.	Color	Description	U.S. Dimensions	U.S. Ship Wt/Ctn	Metric Dimensions	Metric Ship Wt/Ctn	Bag Capacity	Product Weight	Pack
FG9DVPN4400*	YEL, BLA	Power Nozzle Model w/ Deluxe Rim Caddy	39.12" l x 28.5" w x 14" h	57.7 lb	99.4 cm x 72.4 cm x 35.6 cm	26.2 kg	6.5 qt	45.7 lb	1
FG9DVPN4400*	YEL	DVAC Straight Suction Vacuum Cleaner	39.12" l x 28.5" w x 14" h	53.1 lb	99.4 cm x 72.4 cm x 35.6 cm	24.1 kg	6.5 qt	41.2 lb	1
FG9DVPN4400	YEL	Deluxe Rim Caddy (fits BRUTE® 44-Gallon only)	12.7" l x 7.9" w x 0.2" h	7.2 lb	32.3 cm x 20.1 cm x 0.5 cm	3.3 kg	N/A	8.25 lb	1
FG264360	YEL, RED, GRAY, BLUE, BLA	BRUTE® 44-Gallon Utility Container with Venting Channels	24" dia x 31.5" h	49.5 lb	61 cm dia x 80 cm	1.5 kg	44 gal	11.8 lb	4
FG9DVPB10		Replacement Paper Bags (10-pack)	16.25" l x 5.25" w x 0.13" h	13.6 lb	41.3 cm x 13.3 cm x 0.3 cm	6.2 kg	6.5 qt	N/A	10
FG9DVPH10		Replacement HEPA Bags (10-pack)	16.25" l x 5.25" w x 0.13" h	13.6 lb	41.3 cm x 13.3 cm x 0.3 cm	6.2 kg	5.6 qt	N/A	10
FG9DVEF44		Replacement Exhaust Filter (10-pack)	9.51" l x 2.25" w x 0.75" h	9.5 lb	24.2 cm x 5.7 cm x 1.9 cm	4.3 kg	N/A	N/A	10
FG9DVPN12		Replacement Power Nozzle for DVAC (base not included)	22.75" l x 2.25" w x 3.75" h	12.2 lb	57.8 cm x 57.2 cm x 9.5 cm	5.5 kg	N/A	N/A	1

*BRUTE® 44-Gallon Utility Container sold separately.

Mechanical Sweepers

A complete line of commercial sweepers for hard floors and carpets.



New Design!

Floor and Carpet Sweeper

Compact size to collect dust, dirt, and debris in tight spaces.

Dual-Action Bristled Sweeper

Two bristle brush rolls provide effective cleaning power to collect dust, dirt, and debris.

Brushless Mechanical Sweeper

Two agitator rolls provide maximum cleaning power to collect dust, dirt, and debris.

BRISTLE BRUSH ROLL

BRISTLE BRUSH ROLL

RUBBER BRUSH ROLL



CONVENIENT THREADED HANDLE
allows for easy disassembly and compact storage.

CONVENIENT THREADED HANDLE
allows for easy disassembly and compact storage.

CONVENIENT THREADED HANDLE
allows for easy disassembly and compact storage.

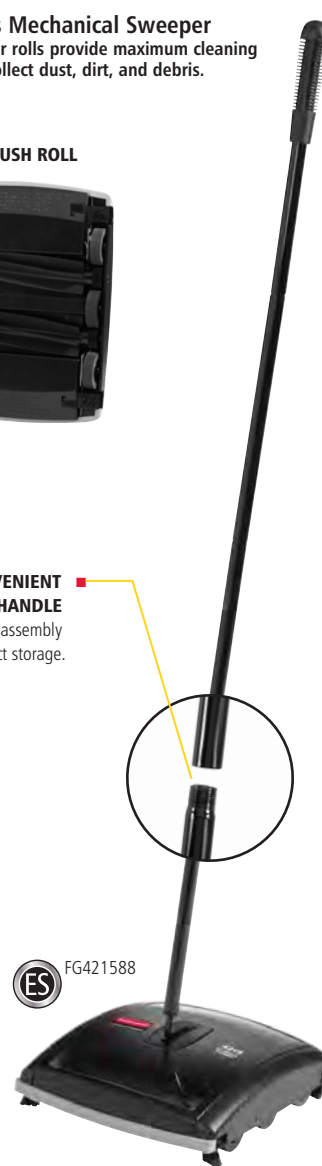
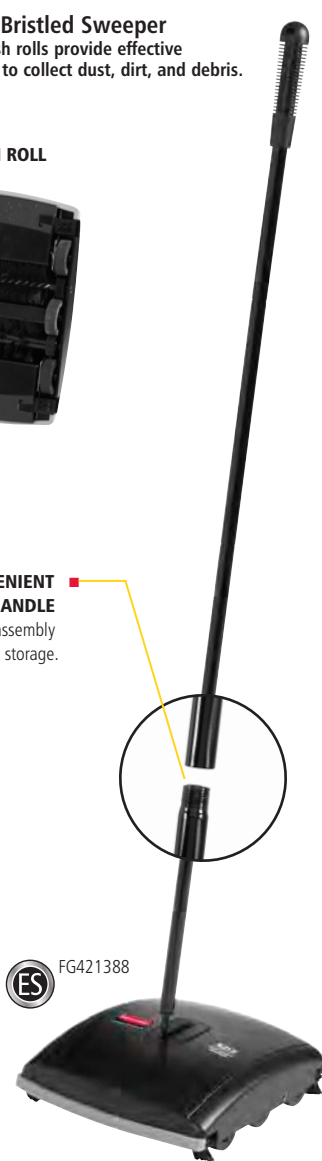
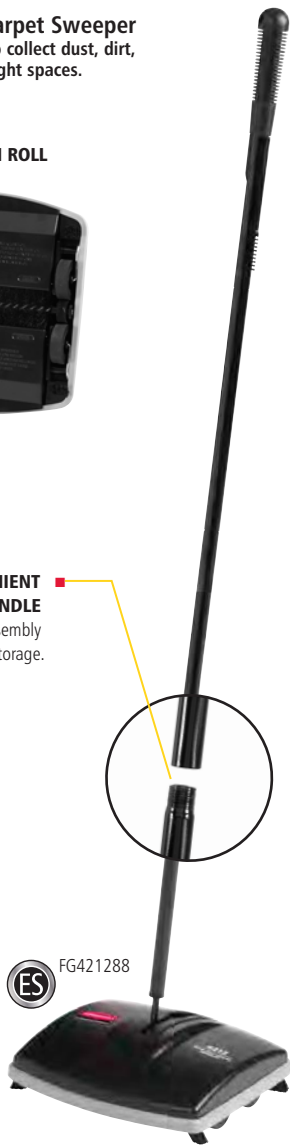

MECHANICAL SWEEPER SELECTION GUIDE

MECHANICAL SWEEPER FEATURES	FG421588 BRUSHLESS MECHANICAL	FG421388 DUAL-ACTION	FG421288 FLOOR AND CARPET
L x W	11 1/4" x 9 1/4"	11 1/4" x 9 1/4"	9 1/4" x 9 1/4"
Sweeping Path	7 1/2"	7 1/2"	6 1/2"
Number of Brushes	Two (Bladed rotors)	Two	One
Debris Capacity	36.8 cu in	36.8 cu in	25 cu in
Debris Canisters	Two with viewing window	Two	One
Corner Brushes	Yes	Yes	Yes
Protective Front and Back Bumper	Yes	Yes	Yes
Soft Handle Grip	Yes	Yes	Yes
Handle Length	40", threaded	40", threaded	40", threaded
Handle Width	3/8"	3/8"	3/8"
Construction	Galvanized steel	Galvanized steel	Galvanized steel
Components	ABS plastic	ABS plastic	ABS plastic
Wheels	Soft rubber	Soft rubber	Soft rubber

WHEN ORDERING PRODUCTS WITH **BOLD** COLOR CODES, PLEASE SPECIFY COLOR CODE AFTER THE PRODUCT NUMBER. REFER TO THE PRODUCT COLOR GUIDE AT THE BACK OF THE CATALOG.



Check out the items marked with this symbol for our new line of Executive Series™ products.

Floor and Carpet Sweeper

Compact size to collect dust, dirt, and debris in tight spaces.

- Constructed of durable galvanized steel and tough ABS plastic
- Low-profile design provides easy access around and under furniture
- Efficient 6.5" sweep path with protective bumper
- Soft rubber wheels glide easily on any surface
- Easy-to-empty trays
- For carpet, tile, wood, vinyl, and more

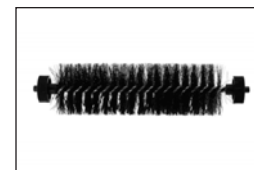

1867399
6.5" BRISTLE BRUSH ROLL

No.	Color	Description	U.S. Dimensions	U.S. Ship Wt/Ctn	Metric Dimensions	Metric Ship Wt/Ctn	Pack
FG421288	BLA	Floor and Carpet Sweeper	9.5" l x 8" w x 44" h	15.6 lb	24.1 cm x 20.3 cm x 111.8 cm	7.1 kg	4
1867399	BLACK	6.5" Bristle Brush Roll (for FG421288)	N/A	N/A	N/A	N/A	1
1867502	BLACK	40" Handle, Threaded (for FG421288, FG421388, FG421588)	N/A	N/A	N/A	N/A	1
1867503	BLACK	6.5" Dirt Tray (for FG421288)	N/A	N/A	N/A	N/A	1

Dual-Action Bristled Sweeper

Two bristle brush rolls provide effective cleaning power to collect dust, dirt, and debris.

- Constructed of durable galvanized steel and tough ABS plastic
- Low-profile design provides easy access around and under furniture
- Efficient 7.5" sweep path with protective bumper
- Soft rubber wheels glide easily on any surface
- Easy-to-empty trays
- For carpet, tile, wood, vinyl, and more

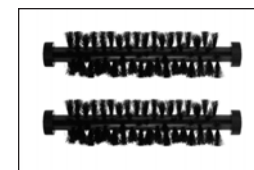

1867400
7.5" BRISTLE BRUSH ROLL

No.	Color	Description	U.S. Dimensions	U.S. Ship Wt/Ctn	Metric Dimensions	Metric Ship Wt/Ctn	Pack
FG421388	BLA	Dual Action Sweeper	10.5" l x 9.5" w x 44" h	19.6 lb	26.7 cm x 24.1 cm x 111.8 cm	8.9 kg	4
1867400	BLACK	7.5" Bristle Brush Roll (for FG421388)	N/A	N/A	N/A	N/A	1
1867502	BLACK	40" Handle, Threaded (for FG421288, FG421388, FG421588)	N/A	N/A	N/A	N/A	1
1867504	BLACK	7.5" Dirt Tray (for FG421388 and FG421588)	N/A	N/A	N/A	N/A	1

Brushless Mechanical Sweeper

Two agitator rolls provide maximum cleaning power to collect dust, dirt, and debris.

- Constructed of durable galvanized steel and tough ABS plastic
- Low-profile design for easy access around and under furniture
- Wide 7.5" sweep path with protective bumper
- Tinted window allows you to see when the sweeper needs emptying
- Easy-to-empty trays
- Soft rubber wheels glide easily on any surface
- For carpet, tile, wood, vinyl, and more



1867501
7.5" RUBBER BRUSH ROLL

No.	Color	Description	U.S. Dimensions	U.S. Ship Wt/Ctn	Metric Dimensions	Metric Ship Wt/Ctn	Pack
FG421588	BLA	Brushless Mechanical Sweeper	10.5" l x 9.5" w x 44" h	19.6 lb	26.7 cm x 24.1 cm x 111.8 cm	8.9 kg	4
1867501	BLACK	7.5" Rubber Brush Roll (for FG421588)	N/A	N/A	N/A	N/A	1
1867502	BLACK	40" Handle, Threaded (for FG421288, FG421388, FG421588)	N/A	N/A	N/A	N/A	1
1867504	BLACK	7.5" Dirt Tray (for FG421388 and FG421588)	N/A	N/A	N/A	N/A	1

Closet Organizer and Tool Holder

Helps increase productivity and efficiency through better tool storage and access.

- S-hooks hold 3/8" to 1 1/4" diameter handles
- Deep double hooks afford easy accessibility
- Clip holds work notes and instructions

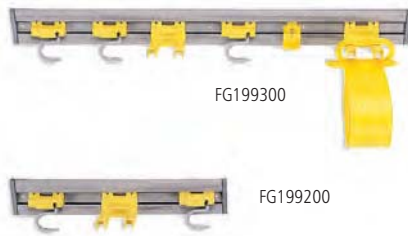

No.	Color	Description	U.S. Dimensions	U.S. Ship Wt/Ctn	Metric Dimensions	Metric Ship Wt/Ctn	Pack
FG199200	GRAY	Closet Organizer/Tool Holder Kit	18" l x 3.25" w x 4.25" h	6.5 lb	45.7 cm x 8.3 cm x 10.8 cm	2.9 kg	6
FG199300	GRAY	Closet Organizer/Tool Holder Kit	34" l x 3.25" w x 4.25" h	10.3 lb	86.4 cm x 8.3 cm x 10.8 cm	4.7 kg	4
FG199400	YEL	Value Kit (2 S-Hooks/1 Double Hook)	3" l x 3.25" w x 4.25" h	0.4 lb	7.6 cm x 8.3 cm x 10.8 cm	0.2 kg	1

Ironing Organizers

Helps prevent hot iron damage.

- Installs easily virtually anywhere
- Efficiently stores iron with ironing board for guest convenience
- Durable heat-resistant thermoset plastic construction
- Aesthetic design complements guest room décor



FG218800



FG245506



FG245506

No.	Color	Description	U.S. Dimensions	U.S. Ship Wt/Ctn	Metric Dimensions	Metric Ship Wt/Ctn	Pack
FG245506	WHT	Ironing Organizer	5.25" l x 15.5" h	10.5 lb	13.3 cm x 39.4 cm	4.8 kg	6
FG218800	WHT	Ironing Organizer	5.75" l x 10" h	5.4 lb	14.6 cm x 25.4 cm	2.4 kg	4

Two-Step Folding Stepstool

Ideal for cleaning activities or whenever elevation assistance is needed.

- Slip-resistant surfaces on steps and foot pads
- Stands upright when folded and requires minimum space for storage
- Supports loads up to 300 lbs (136.1 kg)
- Easy to clean and resistant to dents and rust



FG420903

No.	Color	Description	U.S. Dimensions	U.S. Ship Wt/Ctn	Metric Dimensions	Metric Ship Wt/Ctn	Capacity	Pack
FG420903	CYLN	Two-Step Folding Stepstool	Open: 22 7/8" l x 21" d x 18 7/8" w Closed: 25" l x 5 1/4" d x 18 7/8" w	20.8 lb	58.1 cm x 53.3 cm x 47.9 cm 63.5 cm x 13 cm x 47.9 cm	9.4 kg	300 lb (136 kg)	3

WHEN ORDERING PRODUCTS WITH **BOLD** COLOR CODES, PLEASE SPECIFY COLOR CODE AFTER THE PRODUCT NUMBER. REFER TO THE PRODUCT COLOR GUIDE AT THE BACK OF THE CATALOG.



Check out the items marked with this symbol for our new line of Executive Series™ products.

Mobile Two-Step Stepstool

Heavy-duty stepstool glides on retractable rubber casters.

- Supports loads up to 350 lbs
- Soft, slip-resistant pads on both steps
- Wheels retract when stepped on
- Heavy-duty plastic construction minimizes damage to walls and furniture



FG252300

No.	Color	Description	U.S. Dimensions	U.S. Ship Wt/Ctn	Metric Dimensions	Metric Ship Wt/Ctn	Pack
FG252300	BLA, BEIG	Mobile Two-Step Stepstool	16" dia x 13.5" h	5.9 lb	40.6 cm dia x 34.3 cm	2.7 kg	1

Spray Bottle and Trigger

Makes cleaning easier and more effective.

- Adjustable nozzle, sprays up to 30"
- High-volume 3 cc spray
- Solid HDPE bottle withstands drops and bumps
- Large 3-finger trigger for easy application



FG9C0306

No.	Color	Description	U.S. Dimension	U.S. Capacity	U.S. Ship Wt/Ctn	Metric Dimension	Metric Capacity	Metric Ship Wt/Ctn	Pack
FG9C0306	0000	Assembled Bottle and Spray Trigger	4.8" l x 1.3" w x 13.4" h	3.3 cm ³ /32 oz	4.5 lb	12.2 cm x 3.3 cm x 34 cm	3.3 cm ³ /0.9 L	2.1 kg	12

Deluxe Carry Caddy

All-purpose caddy is perfect for carrying tools or cleaning supplies.

- Heavy-duty caddy conveniently fits on cleaning and housekeeping carts
- Securely holds up to eight 32-oz spray bottles and other common cleaning tools
- Ergonomic handle design provides comfortable fit



FG315488

No.	Color	Description	U.S. Dimensions	U.S. Ship Wt/Ctn	Metric Dimensions	Metric Ship Wt/Ctn	Pack
FG315488	BLA	Deluxe Carry Caddy	15" l x 10.9" w x 7.4" h	7.5 lb	38.1 cm x 27.7 cm x 18.8 cm	3.4 kg	6

COMPLETE CLEANING SYSTEMS

Rubbermaid Commercial Products' cleaning products are designed to work together to form complete cleaning systems. The FG9C0306 Spray Bottle and Trigger fits smartly in BRUTE® Caddies, WaveBrake® Mopping Trolleys, and Cleaning Carts.





Utility and Recycling Refuse



Introducing the new standard of excellence in refuse containers and material handling products.

Since 1968, Rubbermaid Commercial Products has pioneered technologies and system solutions for foodservices, sanitary maintenance, waste handling, material transport, away-from-home washrooms, and safety products.

Today, Rubbermaid Commercial Products continues to expand high-quality, sustainable worldwide solutions focused on improving productivity and reducing costs while providing a healthier workplace. There's no match for our Rubbermaid durability. Every product from BRUTE® utility containers to our carts and trucks features quality materials and heavy-duty construction. Customers around the world know that if it's Rubbermaid, it's made to last.

Versatile solutions for every area of your facility.

Durable Rubbermaid Commercial Products come in a wide range of sizes, shapes, and colors. Whatever your need, we are your trusted partner for smarter refuse solutions.

Make your operation safer and more productive.

Rubbermaid Commercial Products are designed to be easy to lift, move, and manage. Our innovative venting channels and mobile dollies provide superior ergonomics and maneuverability to reduce costs and improve worker productivity.

Get a variety of options for your recycling program.

Rubbermaid Commercial Products offers a broad range of solutions for recycling waste. They include everything from durable containers for recycling office paper to indoor and outdoor station containers and mobile collection equipment. All are available in a broad range of colors and sizes.



Utility and Recycling Refuse

BRUTE® UTILITY AND RECYCLING

BRUTE® Round Containers	127
BRUTE® 44-Gallon Utility Container	128
BRUTE® Lids and Tops.....	129
BRUTE® Dollies	130
BRUTE® Rim Caddy	131
BRUTE® Caddy Bag	131
BRUTE® Square Containers.....	132
Mega BRUTE® Mobile Collector.....	132
BRUTE® Rollout Containers	133

INDOOR UTILITY AND STEP-ONS

Slim Jim® with Venting Channels	134
Slim Jim® Containers.....	134
Slim Jim® Accessories.....	135
Untouchable® Recycling Containers and Tops	136
Untouchable® Containers and Tops.....	137
Deskside Waste and Recycling Baskets and Tops.....	138
Profile Containers	140
Fire-Resistant Wastebaskets.....	140
Step-On Containers.....	141
The Defenders®.....	143
The Silent Defenders®	144
Medi-Can™ Step Cans.....	144
Steel Wastebaskets.....	145

Steel Wastebasket Dome Tops	145
WasteMaster Swing Tops.....	146
WasteMaster Open Tops	146
Hands-Free Pedal Rolltop Container	147

INDOOR UTILITY AND CONFIDENTIAL WASTE

Confidential Refuse Containers	147
--------------------------------------	-----

ADDITIONAL RECYCLING OPTIONS

Outdoor Station Containers	148
Recycling Boxes.....	148
Glutton® Recycling Stations	149
Steel Drum Tops	150

RIGID LINERS

Rigid Liners.....	150
-------------------	-----

CAN LINERS

Can Liners.....	151
-----------------	-----



Resin-based products with this symbol contain, at minimum, 30% post-consumer recycled content.



Metal-based products with this symbol contain, at minimum, 30% post-consumer recycled steel or 70% post-consumer recycled aluminum—which exceeds EPA guidelines.

BRUTE® Containers

Built to be tough. Built to be versatile.

Crush-resistant construction makes BRUTE® all-purpose containers tough enough to stand up to the harshest work environments. Rely on them for all your storage and handling needs.



Optional strong, snap-lock flat lids fit securely, snugly.

Reinforced rim stands up to the toughest conditions.

Tough, built-in, upper handgrips allow for easy lifting.

Innovative shoulder design makes for easy, nonjam nesting.

Exclusive ultraviolet inhibitor protects from damage caused by sun's rays, providing longer life in outdoor applications.

Smooth, seamless construction makes cleaning easy.



Innovative base hand grips make BRUTE® containers easier to lift.



Heavy-duty, double-ribbed bottom construction increases stability and protects against wear from dragging.

Rubbermaid's optional twist-on, twist-off dolly features five rugged casters for stability and increased mobility.



All colors and sizes certified to NSF International Standard #2 (foodservice equipment, handling, and processing) and Standard #21 (containers intended for indoor and outdoor storage of refuse).



BRUTE® Round Containers

Durable, heavy-duty containers for a variety of uses.

- All-plastic, professional-grade construction will not rust, chip, or peel and resists dents
- Strong, snap-on lids provide secure, stable stacking
- Recycling containers come standard with a permanent hot stamp of the universal recycling symbol
- Gray, white, and yellow are USDA Meat and Poultry Equipment Group-listed and assist in complying with HACCP guidelines
- Certified to NSF Standard #2 and Standard #21*
- Multiple colors available to customize waste stream to your needs



Available in a wide variety of sizes and colors.



FG265500



FG264307



FG263246



FG263200



FG262000



FG261000

BRUTE® MULTIPURPOSE

No.	Color	Description	U.S. Dimensions	U.S. Capacity	U.S. Ship Wt/Ctn	Metric Dimensions	Metric Capacity	Metric Ship Wt/Ctn	Can Liners	Pack
FG261000	WHT, GRAY, RED, YEL, DGRN	BRUTE® Container without Lid	15.63" dia x 17.13" h	10 gal	19.0 lb	39.7 cm dia x 43.5 cm	37.9 L	8.6 kg	5003-88	6
1779699	BLUE	BRUTE® Container without Lid	15.63" dia x 17.13" h	10 gal	19.0 lb	39.7 cm dia x 43.5 cm	37.9 L	8.6 kg	5003-88	6
FG262000	YEL, WHT, GRAY, BLUE, RED, DGRN	BRUTE® Container without Lid	19.5" dia x 22.88" h	20 gal	35.0 lb	49.5 cm dia x 58.1 cm	75.7 L	15.9 kg	5006-88	6
FG263200	YEL, WHT, RED, GRAY, DGRN, BLUE	BRUTE® Container without Lid	22" dia x 27.25" h	32 gal	49.5 lb	55.9 cm dia x 69.2 cm	121.1 L	22.5 kg	5007-88	6
FG264300	YEL, WHT, RED, GRAY, DGRN, BLUE	BRUTE® Container without Lid	24" dia x 31.5" h	44 gal	52.3 lb	61 cm dia x 80 cm	166.5 L	23.7 kg	5008-88	4
FG265500	GRAY, DGRN, WHT, RED, YEL	BRUTE® Container without Lid	26.5" dia x 33" h	55 gal	53.0 lb	67.3 cm dia x 83.8 cm	208.2 L	24 kg	5011-88	3
1779732	BLUE	BRUTE® Container without Lid	26.5" dia x 33" h	55 gal	53.0 lb	67.3 cm dia x 83.8 cm	208.2 L	24 kg	5011-88	3

Custom imprinting available; contact Rubbermaid Customer Service at (800) 347-9800 for details.

BRUTE® FOOD PROCESSING

No.	Color	Description	U.S. Dimensions	U.S. Capacity	U.S. Ship Wt/Ctn	Metric Dimensions	Metric Capacity	Metric Ship Wt/Ctn	Can Liners	Pack
FG263246	YEL	BRUTE® Container without Lid with "USDA Condemned" Black Imprint, English and Spanish	22" dia x 27.25" h	32 gal	49.5 lb	55.9 cm dia x 69.2 cm	121.1 L	22.5 kg	5007-88	6
FG263256	GRAY	BRUTE® Container without Lid with "Inedible" Black Imprint, English and Spanish	22" dia x 27.25" h	32 gal	49.5 lb	55.9 cm dia x 69.2 cm	121.1 L	22.5 kg	5007-88	6
FG264346	YEL	BRUTE® Container without Lid with "USDA Condemned" Black Imprint, English and Spanish	24" dia x 31.5" h	44 gal	52.3 lb	61 cm dia x 80 cm	166.5 L	23.7 kg	5008-88	4
FG264356	GRAY	BRUTE® Container without Lid with "Inedible" Black Imprint, English and Spanish	24" dia x 31.5" h	44 gal	52.3 lb	61 cm dia x 80 cm	166.5 L	23.7 kg	5008-88	4

BRUTE® RECYCLING*

No.	Color	Description	U.S. Dimensions	U.S. Capacity	U.S. Ship Wt/Ctn	Metric Dimensions	Metric Capacity	Metric Ship Wt/Ctn	Can Liners	Pack
FG262073*	BLUE	BRUTE® Recycling Container without Lid	19.5" dia x 22.88" h	20 gal	35.0 lb	49.5 cm dia x 58.1 cm	75.7 L	15.9 kg		6
FG263273*	BLUE	BRUTE® Recycling Container without Lid	22" dia x 27.25" h	32 gal	49.5 lb	55.9 cm dia x 69.2 cm	121.1 L	22.5 kg		6
1788472*	GREEN	BRUTE® Recycling Container without Lid	22" dia x 27.25" h	32 gal	49.5 lb	55.9 cm dia x 69.2 cm	121.1 L	22.5 kg		6
FG264307*	BLUE	BRUTE® Recycling Container with Venting Channels	24" dia x 31.5" h	44 gal	49.5 lb	61 cm dia x 80 cm	166.5 L	22.5 kg		4
FG264373*	BLUE	BRUTE® Recycling Container without Lid	24" dia x 31.5" h	44 gal	52.3 lb	61 cm dia x 80 cm	166.5 L	23.7 kg		4
FG353673*	BLUE	BRUTE® Square Recycling Container without Lid	23.5" sq x 28.75" h	40 gal	58.4 lb	59.7 cm sq x 73 cm	151.4 L	26.5 kg		4

*NSF Standards 2 and 21 do not apply to recycling containers.

BRUTE® 44-Gallon Utility Container with Venting Channels

The new BRUTE® with Venting Channels is the most important innovation in refuse collection in decades!

- Smarter ergonomics
- Superior durability
- Liner change-out is fast and safe
- Fits full line of BRUTE® accessories



■ Four can liners cinches allow easy one-step bag retention and eliminate knot tying.

■ Rounded handles provide a comfortable grip.



EASIER HANDLING

Molded base grips on the bottom of the container are deeper and ribbed for better control during emptying.

See it in ACTION
www.rubbermaidbrute.com

OVER **50%** easier**

VENTING CHANNELS

Four venting channels dramatically reduce the force required to remove a filled can liner by over 50%** compared to traditional containers.



All BRUTE® dollies, caddies, and other products and accessories fit the BRUTE® 44-gallon container.



FG264360 YEL



FG264360 RED



FG264360 GRAY



FG264360 BLA



FG264307 BLUE

No.	Color	Description	U.S. Dimensions	U.S. Capacity	U.S. Ship Wt/Ctn	Metric Dimensions	Metric Capacity	Metric Ship Wt/Ctn	Can Liners	Pack
FG264360	YEL, RED, GRAY, BLUE, BLA	BRUTE® 44-Gallon Utility Container with Venting Channels	24" dia x 31.5" h	44 gal	49.5 lb	61 cm dia x 80 cm	166.5 L	22.5 kg	5008-88	4
FG264307	BLUE	BRUTE® Recycling Container with Venting Channels	24" dia x 31.5" h	44 gal	49.5 lb	61 cm dia x 80 cm	166.5 L	22.5 kg	5008-88	4

*NSF Standard 2 Certification and NSF Standard 21 applies to all colors. **Based on internal testing.

WHEN ORDERING PRODUCTS WITH BOLD COLOR CODES, PLEASE SPECIFY COLOR CODE AFTER THE PRODUCT NUMBER. REFER TO THE PRODUCT COLOR GUIDE AT THE BACK OF THE CATALOG.

BRUTE® Lids and Tops

A wide variety for general and specialty use

- Strong, snap-on lids provide secure, stable stacking
- Certified to NSF standard #2 and Standard #21



1788376[†]
Bottles and Cans

1788377[†] Bottles and Cans



1788378[†] Paper

1788379[†] Paper



1788380[†]
Single-Stream

1788471[†] Single-Stream



FG261960

FG263100

FG264560

FG264560 / FG264360
Optional self-draining lid prevents pooling when containers are stored outside.



FG263788

FG354300[†]



FG264788/FG264300

Add an optional dome top to convert 32-gallon and 44-gallon BRUTE® containers to rugged outdoor receptacles. Door swings shut, trapping odors in and keeping water, rodents, and bugs out.

No.	Color	Description	U.S. Dimensions	U.S. Ship Wt/Ctn	Metric Dimensions	Metric Ship Wt/Ctn	Pack
FG260900	YEL, WHT, RED, GRAY, DGRN	Lid for FG261000 BRUTE® Container	16" dia x 1" h	5.1 lb	40.6 cm dia x 2.5 cm	2.3 kg	6
1779700	BLUE	Lid for FG261000 BRUTE® Container	16" dia x 1" h	5.1 lb	40.6 cm dia x 2.5 cm	2.3 kg	6
FG261960	YEL, WHT, RED, GRAY, BLA, DGRN	Lid for FG262000 BRUTE® Container	19.88" dia x 1.8" h	9.2 lb	50.5 cm dia x 4.6 cm	4.2 kg	6
1779731	BLUE	Lid for FG262000 BRUTE® Container	19.88" dia x 1.8" h	9.2 lb	50.5 cm dia x 4.6 cm	4.2 kg	6
FG263100	YEL, WHT, RED, GRAY, DGRN, BLUE	Lid for FG263200 BRUTE® Container	22.25" dia x 1.63" h	12.3 lb	56.5 cm dia x 4.1 cm	5.6 kg	6
FG264560	YEL, WHT, RED, GRAY, BLA, DGRN	Lid for FG264300 and FG264860 Containers	24.5" dia x 1.5" h	11.1 lb	62.2 cm dia x 3.8 cm	5 kg	4
1779636	BLUE	Lid for FG264300 and FG264860 Containers	24.5" dia x 1.5" h	11.1 lb	62.2 cm dia x 3.8 cm	5 kg	4
FG265400	YEL, WHT, RED, GRAY, DGRN	Lid for FG265500 BRUTE® Container	26.75" dia x 2" h	12.5 lb	67.9 cm dia x 5.1 cm	5.7 kg	3
1779733	BLUE	Lid for FG265500 BRUTE® Container	26.75" dia x 2" h	12.5 lb	67.9 cm dia x 5.1 cm	5.7 kg	3
FG263788*	RED, GRAY	BRUTE® Dome Top for FG263200 Container	22.69" dia x 12.25" h	11.1 lb	57.6 cm dia x 31.1 cm	5 kg	1
1829397*	GREEN	BRUTE® Dome Top for FG263200 Container	22.69" dia x 12.25" h	11.1 lb	57.6 cm dia x 31.1 cm	5 kg	1
1829398*	BLUE	BRUTE® Dome Top for FG263200 Container	22.69" dia x 12.25" h	11.1 lb	57.6 cm dia x 31.1 cm	5 kg	1
1829399*	YELLOW	BRUTE® Dome Top for FG263200 Container	22.69" dia x 12.25" h	11.1 lb	57.6 cm dia x 31.1 cm	5 kg	1
FG264788*	RED, GRAY	BRUTE® Dome Top for FG264300 Container	24.81" dia x 12.63" h	12.1 lb	63 cm dia x 32.1 cm	5.5 kg	1
FG265788*	RED, GRAY	BRUTE® Dome Top for FG265500 Container	27.25" dia x 14.5" h	14.1 lb	69.2 cm dia x 36.8 cm	6.4 kg	1
FG354300 [†]	GRAY	Funnel Top for FG263200 Containers	22.38" dia x 5" h	9.8 lb	56.8 cm dia x 12.7 cm	4.4 kg	4
FG9W1300	BLA	Light Duty Container Lid for FG9W1200, FG263200 Containers	22.25" dia x 2.75" h	10.9 lb	56.5 cm dia x 7 cm	4.9 kg	6
1788376 [†]	BLUE	BRUTE® Bottle/Can Recycling Top for FG263200 Container	22.25" dia x 2.75" h	10.9 lb	56.5 cm dia x 7 cm	4.9 kg	6
1788377 [†]	GREEN	BRUTE® Bottle/Can Recycling Top for FG263200 Container	22.25" dia x 2.75" h	10.9 lb	56.5 cm dia x 7 cm	4.9 kg	6
1788378 [†]	BLUE	BRUTE® Paper Recycling Top for FG263200 Container	22.25" dia x 2.75" h	10.9 lb	56.5 cm dia x 7 cm	4.9 kg	6
1788379 [†]	GREEN	BRUTE® Paper Recycling Top for FG263200 Container	22.25" dia x 2.75" h	10.9 lb	56.5 cm dia x 7 cm	4.9 kg	6
1788380 [†]	BLUE	BRUTE® Single-Stream Recycling Top for FG263200 Container	22.25" dia x 2.75" h	10.9 lb	56.5 cm dia x 7 cm	4.9 kg	6
1788471 [†]	GREEN	BRUTE® Single-Stream Recycling Top for FG263200 Container	22.25" dia x 2.75" h	10.9 lb	56.5 cm dia x 7 cm	4.9 kg	6

[†] Provides hands-free product use.

* NSF Standard 2 and NSF Standard 21 Certification applies to all lids except Dome Tops.

BRUTE® Dollies

ROUND AND SQUARE DOLLIES

Easy mobility and maneuverability of heavy loads.

- Swivel casters offer better mobility through work areas
- Heavy-duty 3" casters
- Attach waste containers with easy twist-on/twist-off action

BRUTE® QUIET DOLLY

Perfect for noise-sensitive environments.

- Precision engineering eliminates 88% of dolly noise
- Specifically designed for hospitals, nursing homes, offices, schools, and hospitality facilities
- Nonmarking red Quiet Casters

BRUTE® TRAINABLE DOLLY

For an improved recycling solution.



TILT STABILIZER

Provides an easy way to tilt BRUTE® containers for waste removal.

BALL AND HITCH FEATURE

Allows hands-free connection of up to three BRUTE® containers.



FG265100



FG265100

FG264360 / FG265103 / FG265200

QUIET CASTERS

Reduces noise to allow daytime cleaning activities without workplace disruption.

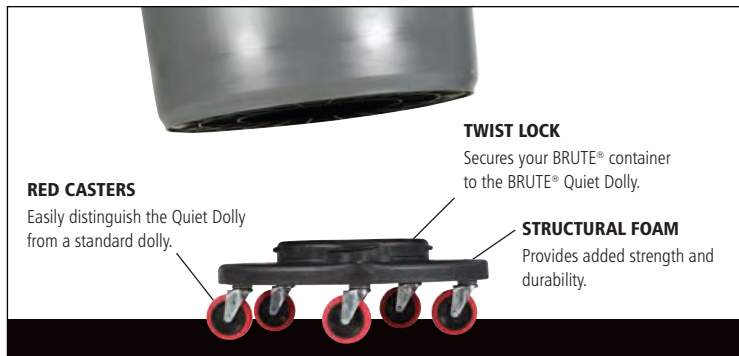

RED CASTERS

Easily distinguish the Quiet Dolly from a standard dolly.

TWIST LOCK

Secures your BRUTE® container to the BRUTE® Quiet Dolly.

STRUCTURAL FOAM

Provides added strength and durability.

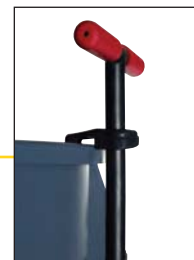

ADJUSTABLE PULL HANDLE CLIP

Pull Handle Accessory attaches to rim of 32-, 44-, or 55-gallon BRUTE® containers when not in use.



PULL HANDLE ACCESSORY

Easily connects to Trainable Dolly for increased control when transporting multiple BRUTE® containers.



FG264043



FG264000



FG265100



FG264600*



FG265000



FG353000

No.	Color	Description	U.S. Dimensions	U.S. Capacity	U.S. Ship Wt/Ctn	Metric Dimensions	Metric Capacity	Metric Ship Wt/Ctn	Pack
FG264000	BLA	BRUTE® Dolly for FG262000, FG263200, FG264300, FG265500 Containers	18.25" dia x 6.63" h	250 lb	13.1 lb	46.4 cm dia x 16.8 cm	113.3 kg	5.9 kg	2
FG264043	BLA	BRUTE® Quiet Dolly for FG262000, FG263200, FG264300, FG265500 Containers	18.25" dia x 6.63" h	250 lb	13.8 lb	46.4 cm dia x 16.8 cm	113.3 kg	6.3 kg	2
FG264600*	BLA	BRUTE® Tandem Dolly for FG262000, FG263200, FG264300, FG265500, FG352600, FG353600 Containers	45" l x 20.25" w x 8" h	200 lb per platform	21.0 lb	114.3 cm x 51.4 cm x 20.3 cm	90.7 kg per platform	9.5 kg per platform	1
FG265000	BLA	Universal Drum Dolly for FG265500 Container	24.38" dia x 7.13" h	500 lb	28.2 lb	61.9 cm dia x 18.1 cm	226.7 kg	12.8 kg	2
FG265100	BLA	BRUTE® Trainable Dolly – 1-Pack	29" l x 21" w x 6.88" h	250 lb	12.6 lb	73.7 cm x 53.3 cm x 17.5 cm	113.3 kg	5.7 kg	1
FG265103	BLA	BRUTE® Trainable Dolly – 3-Pack	N/A	250 lb	35.6 lb	N/A	113.3 kg	16.1 kg	1
FG265200	BLA	BRUTE® Trainable Dolly Pull Handle	N/A	N/A	5.8 lb	N/A	N/A	2.6 kg	1
FG353000	BLA	BRUTE® Square Dolly for FG352600, FG353600 Containers	17.25" sq x 6.25" h	250 lb	18.5 lb	43.8 cm sq x 15.9 cm	113.3 kg	8.4 kg	2

*Does not hold two 55-gal containers.

WHEN ORDERING PRODUCTS WITH BOLD COLOR CODES, PLEASE SPECIFY COLOR CODE AFTER THE PRODUCT NUMBER. REFER TO THE PRODUCT COLOR GUIDE AT THE BACK OF THE CATALOG.



Resin-based products with this symbol meet or exceed EPA guidelines for Post-Consumer Recycled Content.

BRUTE® Rim Caddy

Snaps securely onto the rim of BRUTE® 44-Gallon Containers (FG264300 and FG264360).

- Turn your BRUTE® container into a cleaning cart with storage and transport for spray bottles, wet-floor signs, lobby dust pan, brushes, liners, gloves, and other cleaning supplies*
- Integrated bag straps allow for easy can liner attachment
- User-friendly handle improves maneuverability and minimizes contact with refuse
- Durable construction with smooth surfaces for easy cleaning

*Tools and supplies sold separately.



FG9W8700



FG264900



FG9W8700 Rim Caddy shown on FG264360 BRUTE® 44-Gallon Utility Container with Venting Channels, with FG264043 Quiet Dolly and other accessories sold separately.

No.	Color	Description	U.S. Dimensions	U.S. Ship Wt/Ctn	Metric Dimensions	Metric Ship Wt/Ctn	Pack
FG9W8700	YEL	BRUTE® Rim Caddy for FG264300 Containers	32.5" l x 26.5" w x 6.75" h	4.9 lb	82.6 cm x 67.3 cm x 17.1 cm	2.2 kg	1
FG264900	GRAY	Maid Caddy	16" l x 9" w x 5" h	6.5 lb	40.6 cm x 22.9 cm x 12.7 cm	2.9 kg	4

BRUTE® Caddy Bag

Convenient cleaning storage on the go.

- Turn your BRUTE® container into a cleaning cart with storage and transport for spray bottles, wet-floor signs, lobby dust pan, brushes, liners, gloves, and other cleaning supplies*
- Numerous pockets for all your cleaning supplies
- Durable vinyl material for easy cleaning

*Tools and supplies sold separately.



ES 1867533

Organize all of your cleaning supplies for quick cleanup on the go.

Heavy-duty vinyl material is easily cleaned.



FG264200

No.	Color	Description	U.S. Dimensions	U.S. Ship Wt/Ctn	Metric Dimensions	Metric Ship Wt/Ctn	Pack
FG264200	YEL	BRUTE® Caddy Bag for FG263200, FG264300 Containers	20" dia x 20.5" h	11.3 lb	50.8 cm dia x 52.1 cm	5.1 kg	6
New! ES 1867533	BLACK	Executive Series™ BRUTE® Caddy Bag for FG263200, FG264300 Containers	20" dia x 20.5" h	11.3 lb	50.8 cm dia x 52.1 cm	5.1 kg	6

BRUTE® Square Containers

Increased capacity for storage or refuse collection.

- Square shape offers up to 14% more capacity than round containers
- Tight-fitting indented lid design helps protect dry goods and other contents, while facilitating stacking during transportation and storage
- Nesting handles allow secure fit in side-by-side use
- Gray and white are USDA Meat and Poultry Equipment Group listed and assist in complying with HACCP guidelines
- Product SKU FG351700 Combo meets DOT #178.603, #178.606, and #178.608 criteria for shipping of solid regulated medical waste
- Certified to NSF Std. #2 (Red, Gray, and White) and Std. #21 (Gray and White)
- Customizable with BIOHAZARD symbol or your logo



USDA

CONTAINERS AND LIDS

No.	Color	Description	U.S. Dimensions	U.S. Capacity	U.S. Ship Wt/Ctn	Metric Dimensions	Metric Capacity	Metric Ship Wt/Ctn	Can Liners	Pack
FG351700	RED	Combo Pack includes FG352600 Square BRUTE® Container, FG352900 Snap-Lock® Lid	21.5" sq x 22.63" h	28 gal	74.6 lb	54.6 cm sq x 57.5 cm	106 L	33.8 kg	5016-88 ^a	6
FG352600	WHT, RED, GRAY	BRUTE® Square Container without Lid	21.5" sq x 22.5" h	28 gal	59.8 lb	54.6 cm sq x 57.2 cm	106 L	27.1 kg	5016-88 ^a	6
FG353600	WHT, GRAY	BRUTE® Square Container without Lid	23.5" sq x 28.75" h	40 gal	57.1 lb	59.7 cm sq x 73 cm	151.4 L	25.9 kg	5079, 5013-88 ^a	4
FG353673	BLUE	BRUTE® Square Recycling Container without Lid	23.5" sq x 28.75" h	40 gal	58.4 lb	59.7 cm sq x 73 cm	151.4 L	26.5 kg	5079, 5013-88 ^a	4
FG352700	WHT, RED, GRAY	Lid for FG352600 Container	22" sq x 2" h		16.8 lb	55.9 cm sq x 5.1 cm		7.6 kg		6
FG352900	RED	Snap-Lock® Lid for FG352600 Container	22" sq x 2.13" h		16.8 lb	55.9 cm sq x 5.4 cm		7.6 kg		6
FG353900	WHT, GRAY	Lid for FG353600 Container	24" sq x 2" h		15.3 lb	61 cm sq x 5.1 cm		6.9 kg		4

^aNot for sale in California. NSF Standard 2 Certification applies to containers and lids.

Mega BRUTE® Mobile Collector

Mega BRUTE® Mobile Collector is a highly maneuverable and versatile waste and linen collection and sortation system. Innovative design features deliver improved productivity and ease of use.

- High capacity—120-gallon/400-pound capacity
- Waste and linen sortation options support recycling efforts
- Highly maneuverable; fits through a standard 36" doorway and travels easily on and off most elevators
- Rear doors ease handling of heavy filled liners



Optional lid (FG9W7200) fully covers contents; center hinge allows access to either end of Mega BRUTE® Mobile Collector.



Can Liner Retainer secures a 55-gallon can liner and flips up for easy access to storage area.

2007 EDITORS' CHOICE AWARD WINNER
Top Product Pick
Tools/Equipment Category
BUILDINGS Magazine

SORTATION OPTIONS
Holds an optional 23-gallon Slim Jim® container for improved waste sortation and recycling.

EASILY MANEUVERABLE
Large 12" wheels and 5" nonmarking lockable casters in a diamond pattern allow Mega BRUTE® Mobile Collector to turn on its own axis.

STORAGE AREA
Ideal for storing extra can liners and other cleaning supplies.



No.	Color	Description	U.S. Dimensions	U.S. Capacity	U.S. Ship Wt/Ctn	Metric Dimensions	Metric Capacity	Metric Ship Wt/Ctn	Pack
FG9W7100	BLA	Mega BRUTE® Mobile Waste Collector – 3 Pack	52.5" l x 27.5" w x 42.5" h	120 gal	222.0 lb	133.4 cm x 69.9 cm x 108 cm	454.3 L	100.7 kg	3
FG9W7300	BLA	Mega BRUTE® Mobile Waste Collector – 1 Pack	52.5" l x 27.5" w x 42.5" h	120 gal	74.0 lb	133.4 cm x 69.9 cm x 108 cm	454.3 L	33.6 kg	1
FG9W7200	BLA	Mega BRUTE® Lid	49.5" l x 30" w x 10.5" h	N/A	12.4 lb	125.7 cm x 76.2 cm x 26.7 cm	N/A	5.6 kg	1

WHEN ORDERING PRODUCTS WITH BOLD COLOR CODES, PLEASE SPECIFY COLOR CODE AFTER THE PRODUCT NUMBER. REFER TO THE PRODUCT COLOR GUIDE AT THE BACK OF THE CATALOG.



Resin-based products with this symbol meet or exceed EPA guidelines for Post-Consumer Recycled Content.

BRUTE® Rollout Containers

Easy mobility for material handling, general refuse, and bulk waste collection.

- Available in 50-gallon, 65-gallon, and 90-gallon capacities for improved productivity
- Heavy-duty, well-balanced design delivers added stability in high winds and on uneven surfaces
- Meets ANSI Z245.30-2008 for Types B and G Rollout Cart
- Medical Refuse option available with standard keyed lock to provide increased security



FG9W1900, FG9W2000, FG9W1088, and FG9W1188 include locking mechanisms.

Molded-in catch bar is compatible with virtually any automated lift system.

Inset wheels enable easy movement without damaging walls and doorways.

Attached hinged lid not only fits snugly, but also swings back and locks into place.

Heavy-duty, well-balanced design delivers added stability in high winds and on uneven surfaces.

One-piece seamless construction means superior durability and easy cleaning.

Steel catch bar is compatible with all automated lift systems.



MULTIPURPOSE

No.	Color	Description	U.S. Dimensions	U.S. Capacity	U.S. Ship Wt/Ctn	Metric Dimensions	Metric Capacity	Metric Ship Wt/Ctn	Pack
FG9W2700	YEL, GRAY, BLUE	BRUTE® Rollout Container with Lid	28.5" l x 23.38" w x 36.5" h	50 gal	43.6 lb	72.4 cm x 59.4 cm x 92.7 cm	189.3L	19.8 kg	2
1829410	WHITE	BRUTE® Rollout Container with Lid	28.5" l x 23.38" w x 36.5" h	50 gal	43.6 lb	72.4 cm x 59.4 cm x 92.7 cm	189.3L	19.8 kg	2
1829411	GREEN	BRUTE® Rollout Container with Lid	28.5" l x 23.38" w x 36.5" h	50 gal	43.6 lb	72.4 cm x 59.4 cm x 92.7 cm	189.3L	19.8 kg	2
FG9W2100	GRAY	BRUTE® Rollout Container with Lid	32.3" l x 25.3" w x 41.8" h	65 gal	25.6 lb	82 cm x 64.3 cm x 106.2 cm	246.05 L	11.6 kg	1
FG9W2173	BLUE	BRUTE® Rollout Container with Lid	32.3" l x 25.3" w x 41.8" h	65 gal	25.6 lb	82 cm x 64.3 cm x 106.2 cm	246.05 L	11.6 kg	1
FG9W2200	GRAY	BRUTE® Rollout Container with Lid	35.4" l x 27.3" w x 45.6" h	95 gal	36.0 lb	89.9 cm x 69.3 cm x 115.8 cm	359.6 L	16.3 kg	1
FG9W2273	BLUE	BRUTE® Rollout Container with Lid	35.4" l x 27.3" w x 45.6" h	95 gal	36.0 lb	89.9 cm x 69.3 cm x 115.8 cm	359.6 L	16.3 kg	1

MEDICAL REFUSE

No.	Color	Description	U.S. Dimensions	U.S. Capacity	U.S. Ship Wt/Ctn	Metric Dimensions	Metric Capacity	Metric Ship Wt/Ctn	Pack
FG9W1900	RED	BRUTE® Medical Waste Rollout Container	32.3" l x 25.3" w x 41.8" h	65 gal	30.6 lb	82 cm x 64.3 cm x 106.2 cm	246.05 L	13.9 kg	1
FG9W2000	RED	BRUTE® Medical Waste Rollout Container	35.4" l x 27.3" w x 45.6" h	95 gal	44.0 lb	89.9 cm x 69.3 cm x 115.8 cm	359.6 L	20 kg	1

RECYCLING

No.	Color	Description	U.S. Dimensions	U.S. Capacity	U.S. Ship Wt/Ctn	Metric Dimensions	Metric Capacity	Metric Ship Wt/Ctn	Pack
FG9W2773	BLUE	BRUTE® Recycling Rollout Container with Lid	28.5" l x 23.4" w x 36.5" h	50 gal	43.6 lb	72.4 cm x 59.4 cm x 92.7 cm	189.3L	19.8 kg	2

CONFIDENTIAL DOCUMENT ROLLOUT CONTAINERS

No.	Color	Description	U.S. Dimensions	U.S. Capacity	U.S. Ship Wt/Ctn	Metric Dimensions	Metric Capacity	Metric Ship Wt/Ctn	Pack
FG9W1088	GRAY	BRUTE® Confidential Document Rollout Container	32.3" l x 25.3" w x 41.8" h	65 gal	30.6 lb	82 cm x 64.3 cm x 106.2 cm	246.05 L	13.9 kg	1
FG9W1188	GRAY	BRUTE® Confidential Document Rollout Container	35.4" l x 27.3" w x 45.6" h	95 gal	41.0 lb	89.9 cm x 69.3 cm x 115.8 cm	359.6 L	18.6 kg	1

Slim Jim® with Venting Channels

Slim Jim® with patented Venting Channels features our innovative system that increases efficiency and improves worker well-being.

- Patented integrated venting channels take the strain out of liner removal
- Venting channels dramatically reduce the force required to remove a full can liner up to 60%* when compared to traditional Slim Jim® containers
- Space-saving profile fits virtually anywhere
- Four can liner cinches improve productivity
- Molded-in handles and base grips make lifting and emptying containers easier



OVER **60%** easier*



FG354007

FG354060 shown with optional FG355300 Stainless Steel Dolly.



UV INHIBITOR PROTECTION

Exclusive ultraviolet inhibitor protects from damage caused by sun's rays, providing longer life in outdoor applications.



CAN LINER CINCHES

Four pull-through holes and can liner cinches eliminate knot tying.

No.	Color	Description	U.S. Dimensions	U.S. Capacity	U.S. Ship Wt/Ctn	Metric Dimensions	Metric Capacity	Metric Ship Wt/Ctn	Can Liners	Pack
FG354060**	GRAY, BLA, BEIG	Slim Jim® with Venting Channels	22" l x 11" w x 30" h	23 gal	30.6 lb	55.9 cm x 27.9 cm x 76.2 cm	87.1 L	13.9 kg	5009-88 ^a	4
FG354007	GRN, BLUE	Slim Jim® with Venting Channels – Recycling	22" l x 11" w x 30" h	23 gal	30.6 lb	55.9 cm x 27.9 cm x 76.2 cm	87.1 L	13.9 kg	5009-88 ^a	4
1835530	BLUE	Slim Jim® with Venting Channels and UV-Inhibitors – Outdoor	22" l x 11" w x 30" h	23 gal	30.6 lb	55.9 cm x 27.9 cm x 76.2 cm	87.1 L	13.9 kg	5009-88 ^a	4
1835671	GREEN	Slim Jim® with Venting Channels and UV-Inhibitors – Outdoor	22" l x 11" w x 30" h	23 gal	30.6 lb	55.9 cm x 27.9 cm x 76.2 cm	87.1 L	13.9 kg	5009-88 ^a	4
1835672	GRAY	Slim Jim® with Venting Channels and UV-Inhibitors – Outdoor	22" l x 11" w x 30" h	23 gal	30.6 lb	55.9 cm x 27.9 cm x 76.2 cm	87.1 L	13.9 kg	5009-88 ^a	4

**Custom imprinting available; contact Rubbermaid Customer Service at (800) 347-9800 for details.

*Not for sale in California.

*Based on internal testing.

Slim Jim® Containers

The industry standard in space-saving waste management.

- Efficient size and shape designed to fit in tight spaces
- Durable, all-plastic construction is easy-to-clean
- Handled versions make lifting and carrying easier
- Bottom hand-holds provide a secure grip during emptying



FG354000 and FG354075 Available in multiple colors to simplify waste separation.



FG352073



Slim Jim® Combo FG354220



FG354173



FG354173 with FG270388 lid

No.	Color	Description	U.S. Dimensions	U.S. Capacity	U.S. Ship Wt/Ctn	Metric Dimensions	Metric Capacity	Metric Ship Wt/Ctn	Can Liners	Pack
FG354000*	YEL, GRAY, BRN, BLUE, BLA, BEIG	Slim Jim® Waste Container	20" l x 11" w x 30" h	23 gal	32.9 lb	50.8 cm x 27.9 cm x 76.2 cm	87.1 L	14.9 kg	5009-88 ^a	4
FG354075	BLUE	Slim Jim® Recycling Container	20" l x 11" w x 30" h	23 gal	30.2 lb	50.8 cm x 27.9 cm x 76.2 cm	87.1 L	13.7 kg	5009-88 ^a	4
FG354100	LGRAY, DBLUE, BEIG	Slim Jim® Waste Container with Handles	23.13" l x 11" w x 24.88" h	15% gal	34.6 lb	58.8 cm x 27.9 cm x 63.2 cm	60 L	15.7 kg	5009-88 ^a	4
FG354173	BLUE	Slim Jim® Recycling Container with Handles	23.13" l x 11" w x 24.88" h	15% gal	34.6 lb	58.7 cm x 27.9 cm x 63.2 cm	60 L	15.7 kg	5009-88 ^a	4
FG352073	BLUE	Half-Round Recycling Container	21" l x 11" w x 28" h	21 gal	30.1 lb	53.3 cm x 27.9 cm x 71.1 cm	79.5 L	13.7 kg		4

*Custom imprinting available; contact Rubbermaid Customer Service at (800) 347-9800 for details.

*Not for sale in California.

WHEN ORDERING PRODUCTS WITH BOLD COLOR CODES, PLEASE SPECIFY COLOR CODE AFTER THE PRODUCT NUMBER. REFER TO THE PRODUCT COLOR GUIDE AT THE BACK OF THE CATALOG.



Resin-based products with this symbol meet or exceed EPA guidelines for Post-Consumer Recycled Content.

Slim Jim® Accessories

Promote recycling and improve productivity.

TOPS

- Encourage waste separation and recycling with interchangeable, color-coded tops
- New Swing Lid conceals waste from view and provides greater access
- New Hinge Lid folds flat while in use and completely covers waste when closed; complies with Health and Human Services Standard 5-501.113 of the 2005 FDA Food Code

TROLLEY AND DOLLY

- Use trolley singly as a dolly or link multiple Slim Jim® Containers to reduce collection trips
- New Stainless Steel Dolly with plastic casters resists chemicals, rust, and corrosion for use in wet environments



FG355188 with FG354220 / FG270388 / FG269288



1792975

Recycle Label Kit includes one set of 11 color-coded symbol labels and three sets of 11 word labels in English, Spanish, and French.



FG355300



FG270388 Paper / FG268888 Handle Top / FG269288 Bottle and Can



1788373 Single-Stream



FG267360 with FG2671400

TOPS

No.	Color	Description	U.S. Dimensions	U.S. Ship Wt/Ctn	Metric Dimensions	Metric Ship Wt/Ctn	Pack
FG267360	BEIG, BLA, GRAY	Slim Jim® Swing Lid for Slim Jim® Containers	20.5" l x 11.38" w x 5" h	12.5 lb	52.1 cm x 28.9 cm x 12.7 cm	5.7 kg	4
1829400	GREEN	Slim Jim® Swing Lid for Slim Jim® Containers	20.5" l x 11.38" w x 5" h	12.5 lb	52.1 cm x 28.9 cm x 12.7 cm	5.7 kg	4
FG267400	BLA	Slim Jim® Hinge Lid for Slim Jim® Containers	21.88" l x 13.5" w x 1.25" h	6.5 lb	55.6 cm x 34.3 cm x 3.2 cm	2.9 kg	4
FG268888	LGRAY, BRN, YEL	Slim Jim® Handle Top for Slim Jim® Containers	20.38" l x 11.3" w x 2.75" h	4.7 lb	51.8 cm x 28.7 cm x 7 cm	2.1 kg	4
FG269288	GRN, BRN, BLUE	Slim Jim® Bottle and Can Recycling Top for Slim Jim® Containers	20.38" l x 11.3" w x 2.75" h	3.9 lb	51.8 cm x 28.7 cm x 7 cm	1.8 kg	4
FG270388	GRN, BLUE	Slim Jim® Paper Recycling Top for Slim Jim® Containers	20.5" l x 11.5" w x 2.75" h	4.1 lb	52.1 cm x 29.2 cm x 7 cm	1.9 kg	4
1788372	BLUE	Slim Jim® Single-Stream Recycling Top for Slim Jim® Containers	20.38" l x 11.3" w x 2.75" h	3.9 lb	51.8 cm x 28.7 cm x 7 cm	1.9 kg	4
1788373	GREEN	Slim Jim® Single-Stream Recycling Top for Slim Jim® Containers	20.38" l x 11.3" w x 2.75" h	3.9 lb	51.8 cm x 28.7 cm x 7 cm	1.9 kg	4

COMBO

No.	Color	Description	U.S. Ship Wt/Ctn	Metric Ship Wt/Ctn	Can Liners	Pack
FG354220	0000	Slim Jim® Combo: FG354100 (1) Light Gray, FG268888 (1) Light Gray	29.1 lb	13.2 kg	5009-88*	4

*Not for sale in California.

LABEL KIT

No.	Color	Description	U.S. Dimensions	U.S. Capacity	U.S. Ship Wt/Ctn	Metric Dimensions	Metric Capacity	Metric Ship Wt/Ctn	Pack
1792975		Recycle Label Kit	N/A	N/A	N/A	N/A	N/A	N/A	8

TROLLEY & DOLLY

No.	Color	Description	U.S. Dimensions	U.S. Capacity	U.S. Ship Wt/Ctn	Metric Dimensions	Metric Capacity	Metric Ship Wt/Ctn	Pack
FG355188	BLA	Slim Jim® Trolley for FG354000, FG354100 Containers	23.4" l x 15" w x 10.8" h	80 lb unhooked, total 120 lb 2, 3, or 4 hooked	20.8 lb	59.4 cm x 38.1 cm x 27.4 cm	36.3 kg unhooked, total 54.4 kg 2, 3, or 4 hooked	9.4 kg	2
FG355300	SSSTL	Slim Jim® Stainless Steel Dolly for Slim Jim® Containers	20.38" l x 9.38" w x 9.5" h	120 lbs	14.5 lb	51.8 cm x 23.8 cm x 24.1 cm	54.5 kg	6.6 kg	2

Untouchable® Recycling Containers and Tops



For use in high-volume areas.

- Containers provide convenient central collection sites for multiple workstations or areas
- All containers come standard with the universal recycling symbol imprint
- Create a customized recycling program with additional label kit



GLASS		TRASH	
PLASTIC		CANS / PLASTIC	
CANS		ORGANIC	
WHITE PAPER ONLY		TRASH	
GLASS / CANS / PLASTIC		RECYCLE	
PAPER			

1792975
Recycle Label Kit includes one set of 11 color-coded symbol labels and three sets of 11 word labels in English, Spanish, and French.



FG395873



FG356973 / FG269000 Paper



FG356973 / FG269100 Bottle and Can



FG356907 / 1788375 Single-Stream



FG356973 / 1788374 Single-Stream



1788374 Single-Stream



1788375 Single-Stream



FG269000 Paper

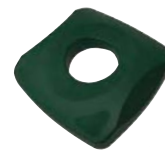

FG269100 Bottle and Can

No.	Color	Description	U.S. Dimensions	U.S. Capacity	U.S. Ship Wt/Ctn	Metric Dimensions	Metric Capacity	Metric Ship Wt/Ctn	Can Liners	Pack
FG356907	GRN	Untouchable® Square Recycling Container	16.5" l x 15.5" w x 30.9" h	23 gal	21.2 lb	41.9 cm x 39.4 cm x 78.5 cm	87.1 L	9.6 kg	5005-88*	4
FG356973	BLUE	Untouchable® Square Recycling Container	16.5" l x 15.5" w x 30.9" h	23 gal	21.2 lb	41.9 cm x 39.4 cm x 78.5 cm	87.1 L	9.6 kg	5005-88*	4
FG395873	BLUE	Square Recycling Container	19.5" sq x 27.63" h	35 gal	39.4 lb	49.5 cm sq x 70.2 cm	132.5 L	17.9 kg		4
FG395973	BLUE	Square Recycling Container	19.5" sq x 34.25" h	50 gal	53.9 lb	49.5 cm sq x 87 cm	189.3 L	24.4 kg		4

TOPS AND LABEL KIT

No.	Color	Description	U.S. Dimensions	U.S. Ship Wt/Ctn	Metric Dimensions	Metric Ship Wt/Ctn	Pack
1792975	N/A	Recycle Label Kit	N/A	N/A	N/A	N/A	8
FG279100	DBLUE	Untouchable® Bottle and Can Recycling Top for FG395806, FG395906 Containers	20.13" sq x 6.25" h	28.2 lb	51.1 cm sq x 15.9 cm	12.8 kg	4
FG279400	DBLUE	Untouchable® Paper Recycling Top for FG395806, FG395906 Containers	20.13" sq x 6.25" h	28.2 lb	51.1 cm sq x 15.9 cm	12.8 kg	4
1788374	BLUE	Untouchable® Single-Stream Recycling Top for FG356900 Container	16" sq x 3.2" h	4.6 lb	40.6 cm sq x 8.1 cm	2.1 kg	4
1788375	GREEN	Untouchable® Single-Stream Recycling Top for FG356900 Container	16" sq x 3.2" h	4.6 lb	40.6 cm sq x 8.1 cm	2.1 kg	4
FG269000	BLUE, GRN	Untouchable® Paper Recycling Top for FG356900 Containers	16" sq x 3.2" h	4.7 lb	40.6 cm sq x 8.1 cm	2.1 kg	4
FG269100	BLUE, GRN	Untouchable® Bottle and Can Recycling Top for FG356900 Container	16" sq x 3.2" h	4.6 lb	40.6 cm sq x 8.1 cm	2.1 kg	4

*Not for sale in California.

WHEN ORDERING PRODUCTS WITH **BOLD** COLOR CODES, PLEASE SPECIFY COLOR CODE AFTER THE PRODUCT NUMBER. REFER TO THE PRODUCT COLOR GUIDE AT THE BACK OF THE CATALOG.



Resin-based products with this symbol meet or exceed EPA guidelines for Post-Consumer Recycled Content.

Untouchable® Containers and Tops

Versatile and tough for indoor or outdoor applications.

Available in round, half-round, and square shapes.



ADA COMPLIANT

- Durable and crack-resistant, even under tough indoor/outdoor conditions
- Compact, square profile fits in angled spaces
- Perfect for hotel lobbies, offices, restrooms, shopping malls, restaurants, and other public locations
- Drop-and-swing lid design provides easy access and quickly returns to hide refuse from public view
- Controls litter, odors, and insects



Integrated pull-through hole and can liner cinch.

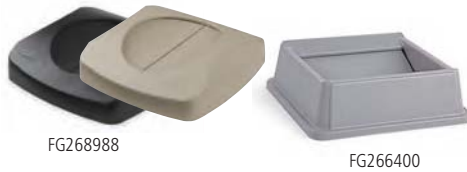

FG268988

FG266400



FG356988 / FG268988



FG356988



FG354600 with FG354800 Top



FG352000 with FG362000 Top



FG792020 Combo

No.	Color	Description	U.S. Dimensions	U.S. Capacity	U.S. Ship Wt/Ctn	Metric Dimensions	Metric Capacity	Metric Ship Wt/Ctn	Can Liners	Pack
FG294700	GRAY	Untouchable® Round Container	15.75" dia x 18.75" h	44.37 qt	15.0 lb	40 cm dia x 47.6 cm	42 L	6.8 kg	5003-88 ^a	6
FG352000	GRAY, BEIG	Untouchable® Half Round Container	21" l x 11" w x 28" h	21 gal	30.1 lb	53.3 cm x 27.9 cm x 71.1 cm	79.5 L	13.7 kg	5005-88 ^a	4
FG354600	GRAY, BEIG	Untouchable® Round Container	15.75" dia x 30.13" h	22 gal	27.6 lb	40 cm dia x 76.5 cm	83.3 L	12.5 kg	5004-88 ^a	4
FG356988	GRAY, BEIG, BRN, BLA	Untouchable® Square Container	16.5" l x 15.5" w x 30.9" h	23 gal	21.2 lb	41.9 cm x 39.4 cm x 78.5 cm	87.1 L	9.6 kg	5005-88 ^a	4
FG395800	GRAY, BEIG	Untouchable® Square Container (liner for FG917100/FG917300/FG396500)	19.5" sq x 27.63" h	35 gal	39.4 lb	49.5 cm sq x 70.2 cm	132.5 L	17.9 kg	5008-88 ^a	4
FG395900	GRAY, BEIG	Untouchable® Square Container (liner for FG917500/FG917600)	19.5" sq x 34.25" h	50 gal	53.9 lb	49.5 cm sq x 87 cm	189.3 L	24.4 kg	5008-88 ^a	4
FG792020	BEIG	Untouchable® Square Container with Swing Lid Combo	16" l x 16.8" w x 34.1" h	23 gal	9.0 lb	40.6 cm x 42.7 cm x 86.6 cm	87.1 L	4.1 kg	5004-88 ^a	1
FG266400	GRAY, BEIG	Untouchable® Square Swing Top for FG395800, FG395900 Containers	20.13" sq x 6.25" h		22.7 lb	51.1 cm sq x 15.9 cm		10.3 kg		4
FG267200	GRAY, BEIG	Untouchable® Round Swing Top for FG294700, FG354600 Containers	16.13" dia		8.5 lb	41 cm dia		3.9 kg		4
FG268988	GRAY, BEIG, BLA	Untouchable® Swing Top for FG356907, FG356988 Containers	16" sq x 4" h		12.6 lb	40.6 cm sq x 10.2 cm		5.7 kg		4
FG354800 ^a	GRAY	Untouchable® Round Funnel Top for FG294700, FG354600 Containers	16.25" dia		5.5 lb	41.3 cm dia		2.5 kg		4
FG362000	BLA	Untouchable® Half-Round Lid, with Swing Door, for FG352000, FG352073 Containers	21.06" sq x 9.5" h		12.1 lb	53.5 cm sq x 24.1 cm		5.5 kg		4

^aCustom imprinting available; contact Rubbermaid Customer Service for details.

Deskside Waste and Recycling Baskets and Tops

Space-efficient, economical, and an easy and effective way to recycle.



- Rolled rims add strength and are easy-to-clean
- Fits under standard-height desk even when swing top is fully extended
- Designed for convenient deskside waste management
- Tops provide a hygienic waste management solution without reducing wastebasket capacity
- Untouchable® Top adds an aesthetic, cost-efficient upgrade to your waste collection system



■ Rolled rim adds strength to the already durable Rubbermaid design.

■ Designed to fit under any standard desk or counter while handling all the waste in a day's work.

■ Innovative rim tabs prevent jamming when nested.

■ Rubbermaid's reliable, puncture-resistant, all-plastic construction means they won't rust or chip and will stand up to years of use.

Side bins create a compact deskside recycling center.

- Add side bins to turn a regular wastebasket into a convenient recycling station
- Customize with different colors for all your recycling sortation needs



FG295600

FG295673 with FG295073 Side Bin

■ Rounded corners and smooth contours make for easy cleaning and emptying.



DESKSIDE WASTEBASKETS

No.	Color	Description	U.S. Dimensions	U.S. Capacity	U.S. Ship Wt/Ctn	Metric Dimensions	Metric Capacity	Metric Ship Wt/Ctn	Can Liners	Pack
FG295200	BEIG	Wastebasket, Vanity	9.88" l x 6.75" w x 10.13" h	8½ qt	4.4 lb	25.1 cm x 17.1 cm x 25.7 cm	7.7 L	2 kg	5002-88 [▲]	6
FG295500	GRAY, BEIG, BLA	Wastebasket, Small	11.38" l x 8.25" w x 12.13" h	13¾ qt	15.6 lb	28.9 cm x 21 cm x 30.8 cm	12.9 L	7.1 kg	5002-88 [▲]	12
1829412	GREEN	Wastebasket, Small	11.38" l x 8.25" w x 12.13" h	13¾ qt	15.6 lb	28.9 cm x 21 cm x 30.8 cm	12.9 L	7.1 kg	5002-88 [▲]	12
FG295600	GRAY, BEIG, BLA	Wastebasket, Medium	14.38" l x 10.25" w x 15" h	28¾ qt	23.5 lb	36.5 cm x 26 cm x 38.1 cm	26.6 L	10.7 kg	5002-88 [▲]	12
FG295700	GRAY, BEIG, BLA	Wastebasket, Large	15.25" l x 11" w x 19.88" h	41¼ qt	29.4 lb	38.7 cm x 27.9 cm x 50.5 cm	39 L	13.3 kg	5003-88 [▲]	12
1829406	GREEN	Wastebasket, Large	15.25" l x 11" w x 19.88" h	41¼ qt	29.4 lb	38.7 cm x 27.9 cm x 50.5 cm	39 L	13.3 kg	5003-88 [▲]	12

DESKSIDE RECYCLING CONTAINERS

No.	Color	Description	U.S. Dimensions	U.S. Capacity	U.S. Ship Wt/Ctn	Metric Dimensions	Metric Capacity	Metric Ship Wt/Ctn	Pack
FG295073	GRN, BLUE, GRAY, BLA	Side Bin Recycling Center (fits FG295600 and FG295700) wastebaskets)	10.6" l x 7.3" w x 11.7" h	13¾ qt	9.0 lb	26.9 cm x 18.5 cm x 29.7 cm	12.9 L	4.1 kg	12
FG295573	BLUE	Deskside Recycling Container, Small with Universal Recycle Symbol	11.4" l x 8.25" w x 12.13" h	13¾ qt	15.6 lb	29 cm x 21 cm x 30.8 cm	12.9 L	7.1 kg	12
FG295606	GRN	Deskside Recycling Container, Medium with Universal Recycle Symbol	14.38" l x 10.25" w x 15" h	28¾ qt	23.5 lb	36.5 cm x 26 cm x 38.1 cm	26.6 L	10.7 kg	12
FG295673	BLUE	Deskside Recycling Container, Medium with Universal Recycle Symbol	14.38" l x 10.25" w x 15" h	28¾ qt	23.5 lb	36.5 cm x 26 cm x 38.1 cm	26.6 l	10.7 kg	12
FG295773	BLUE	Deskside Recycling Container, Large with Universal Recycle Symbol	15.25" l x 11" w x 19.9" h	41¼ qt	29.4 lb	38.7 cm x 27.9 cm x 50.5 cm	39 L	13.3 kg	12

UNTOUCHABLE® TOPS AND COMBO

No.	Color	Description	U.S. Dimensions	U.S. Ship Wt/Ctn	Metric Dimensions	Metric Ship Wt/Ctn	Can Liners	Pack
FG306600	BLA, BEIG	Untouchable® Top for FG295600 Container	15" l x 10.88" w x 6" h	7.5 lb	38.1 cm x 27.6 cm x 15.2 cm	3.4 kg		6
1779742	GRAY	Untouchable® Top for FG295600 Container	15" l x 10.88" w x 6" h	7.5 lb	38.1 cm x 27.6 cm x 15.2 cm	3.4 kg		6
FG306700	BLA, BEIG	Untouchable® Top for FG295700 Container	16" l x 11.63" w x 7" h	8.5 lb	40.6 cm x 29.5 cm x 17.8 cm	3.9 kg		6
1829407	GREEN	Untouchable® Top for FG295700 Container	16" l x 11.63" w x 7" h	8.5 lb	40.6 cm x 29.5 cm x 17.8 cm	3.9 kg		6
1829408	BLUE	Untouchable® Top for FG295700 Container	16" l x 11.63" w x 7" h	8.5 lb	40.6 cm x 29.5 cm x 17.8 cm	3.9 kg		6
1829409	GRAY	Untouchable® Top for FG295700 Container	16" l x 11.63" w x 7" h	8.5 lb	40.6 cm x 29.5 cm x 17.8 cm	3.9 kg		6
FG307120	BEIG	Untouchable® Top/Soft Wastebasket Combo: FG306700 Lid/FG295700 Wastebasket	N/A	22.9 lb	N/A	10.4 kg	5003-88 [▲]	6

Profile Containers

Attractive design suits many decors.

- Wall mounting keeps the container out of pedestrian traffic and allows for floor cleaning
- Spring-loaded swing door helps control odor and hides trash from public view
- Comes with complete hardware and instructions for wall mounting
- Factory Mutual (FM) approved for fire safety when wall mounted; ideal for hallways and other uncontrolled public areas
- Slim design limits intrusion into corridors, washrooms, kitchens, and other limited space areas



ADA COMPLIANT



1829403

FG782200

1829401



FG200GL



FG782200

No.	Color	Description	U.S. Dimensions	U.S. Capacity	U.S. Ship Wt/Ctn	Metric Dimensions	Metric Capacity	Metric Ship Wt/Ctn	Can Liners	Pack
FG782200	BRN, BEIG	Slim Jim® Wall-Mounted Container	19.5" l x 11.88" w x 32.63" h	15 gal	11.4 lb	49.5 cm x 30.2 cm x 82.9 cm	56.8 L	5.2 kg	5005-88 ^a	1
1829401	BLUE	Slim Jim® Wall-Mounted Container	19.5" l x 11.88" w x 32.63" h	15 gal	11.4 lb	49.5 cm x 30.2 cm x 82.9 cm	56.8 L	5.2 kg	5005-88 ^a	1
1829402	RED	Slim Jim® Wall-Mounted Container	19.5" l x 11.88" w x 32.63" h	15 gal	11.4 lb	49.5 cm x 30.2 cm x 82.9 cm	56.8 L	5.2 kg	5005-88 ^a	1
1829403	GREEN	Slim Jim® Wall-Mounted Container	19.5" l x 11.88" w x 32.63" h	15 gal	11.4 lb	49.5 cm x 30.2 cm x 82.9 cm	56.8 L	5.2 kg	5005-88 ^a	1
1829404	YELLOW	Slim Jim® Wall-Mounted Container	19.5" l x 11.88" w x 32.63" h	15 gal	11.4 lb	49.5 cm x 30.2 cm x 82.9 cm	56.8 L	5.2 kg	5005-88 ^a	1
FG200GL	WH	Wall-Mounted Litter Receptacle	19" l x 39" w x 8" h	12 gal	4 lb	48.3 cm x 99.1 cm x 20.3 cm	1.3 L	1.8 kg	-	1

^aNot for sale in California.

Fire Resistant Wastebaskets

Contemporary shape with UL rating.

- Great for use in areas requiring increased levels of fire protection, such as hospitals, schools, and hotels
- Fiberglass containers have rounded corners for added strength
- Textured finish helps minimize appearance of surface scratches and is easy-to-clean
- Tested and classified by Underwriters Laboratories as able to contain burning paper without causing wastebasket meltdown



CSFM

FG254400



FG254100

FG254000

FG254300



No.	Color	Description	U.S. Dimensions	U.S. Capacity	U.S. Ship Wt/Ctn	Metric Dimensions	Metric Capacity	Metric Ship Wt/Ctn	Pack
FG254000	BEIG	Fire-Resistant Wastebasket	8.88" l x 6.38" w x 10.8" h	7 qt	10.2 lb	22.6 cm x 16.2 cm x 27.4 cm	6.6 L	4.6 kg	6
FG254100	GRAY, BLA, BEIG	Fire-Resistant Wastebasket	11.13" l x 8.25" w x 12.25" h	14 qt	17.8 lb	28.3 cm x 21 cm x 31.1 cm	13.2 L	8.1 kg	6
FG254300	GRAY, BLA, BEIG	Fire-Resistant Wastebasket	14.5" l x 10.5" w x 15.3" h	28 qt	31.8 lb	36.8 cm x 26.7 cm x 38.9 cm	26.5 L	14.4 kg	6
FG254400	BEIG	Fire-Resistant Wastebasket	15" l x 11.25" w x 20" h	40 qt	33.0 lb	38.1 cm x 28.6 cm x 50.8 cm	37.9 L	15 kg	4

For Other Fire Rated Containers See:



Profile
Wall-Mounted



Step-On
Containers



Steel Containers



WasteMaster
Containers



Plaza® Containers



Ranger®
Containers



Smoking Management
Containers

WHEN ORDERING PRODUCTS WITH **BOLD** COLOR CODES, PLEASE SPECIFY COLOR CODE AFTER THE PRODUCT NUMBER. REFER TO THE PRODUCT COLOR GUIDE AT THE BACK OF THE CATALOG.



Metal-based products with this symbol meet or exceed EPA guidelines for Post-Consumer Recycled Content.

Step-On Containers

Provides sanitary waste management.

- Tight-fitting, overlapping lid helps contain odors
- Tough, puncture-resistant, all-plastic construction won't rust or chip
- Quiet, heavy-duty pedal for hands-free sanitary use
- Assists in complying with OSHA regulation 29 CFR 1910.1030 "Occupational Exposure to Bloodborne Pathogens"
- Optional rigid liners for FG614300, FG614400, FG614500, and FG614600 provide a leak-proof base



OSHA



Medical Waste Approved



No.	Color	Description	U.S. Dimensions	U.S. Capacity	U.S. Ship Wt/Ctn	Metric Dimensions	Metric Capacity	Metric Ship Wt/Ctn	Can Liners	Pack
FG614200	WHT, YEL	Step-On Can with Rigid Liner	13.25" dia x 15.38" h	4.5 gal	9.1 lb	33.7 cm dia x 39.1 cm	17 L	4.1 kg	5002-88 ^a	1
FG614300	WHT, YEL, RED, BEIG	Step-On Container	16.25" l x 15.75" w x 17.13" h	8 gal	7.9 lb	41.3 cm x 40 cm x 43.5 cm	30.3 L	3.6 kg	5004-88 ^a	1
FG624300	GRAY	Rigid Liner for FG614300 Container	14.38" l x 11.75" w x 13.25" h	7 $\frac{1}{2}$ gal	5.4 lb	36.5 cm x 29.8 cm x 33.7 cm	27 L	2.4 kg		2
1829413	GREEN	Step-On Container	16.25" l x 15.75" w x 17.13" h	8 gal	7.9 lb	41.3 cm x 40 cm x 43.5 cm	30.3 L	3.6 kg	5004-88 ^a	1
1829414	BLUE	Step-On Container	16.25" l x 15.75" w x 17.13" h	8 gal	7.9 lb	41.3 cm x 40 cm x 43.5 cm	30.3 L	3.6 kg	5004-88 ^a	1
1829415	GRAY	Step-On Container	16.25" l x 15.75" w x 17.13" h	8 gal	7.9 lb	41.3 cm x 40 cm x 43.5 cm	30.3 L	3.6 kg	5004-88 ^a	1
FG614400	WHT, YEL, RED, BEIG	Step-On Container	16.25" l x 15.75" w x 23.63" h	12 gal	10.0 lb	41.3 cm x 40 cm x 60 cm	45.4 L	4.5 kg	5004-88 ^a	1
FG624400	GRAY	Rigid Liner for FG614400 Container	14.38" l x 11.75" w x 19.75" h	10 $\frac{1}{4}$ gal	7.9 lb	36.5 cm x 29.8 cm x 50.2 cm	38.8 L	3.6 kg		2
1829416	BLUE	Step-On Container	16.25" l x 15.75" w x 23.63" h	12 gal	10.0 lb	41.3 cm x 40 cm x 60 cm	45.4 L	4.5 kg	5004-88 ^a	1
1829417	GREEN	Step-On Container	16.25" l x 15.75" w x 23.63" h	12 gal	10.0 lb	41.3 cm x 40 cm x 60 cm	45.4 L	4.5 kg	5004-88 ^a	1
FG614500	WHT, YEL, RED, BEIG	Step-On Container	19.75" l x 16.13" w x 26.5" h	18 gal	13.0 lb	50.2 cm x 41 cm x 67.3 cm	68.1 L	5.9 kg	5009-88 ^a	1
FG624500	GRAY	Rigid Liner for FG614500 Container	18" l x 12.25" w x 22" h	15 gal	26.4 lb	45.7 cm x 31.1 cm x 55.9 cm	56.8 L	12 kg		4
FG614600	WHT, YEL, RED, BEIG	Mobile Step-On Container	19.75" l x 16.13" w x 32.5" h	23 gal	18.0 lb	50.2 cm x 41 cm x 82.6 cm	87.1 L	8.2 kg	5009-88 ^a	1
FG624600	GRAY	Rigid Liner for FG614600 Container	18" l x 12.25" w x 28.5" h	19 gal	30.6 lb	45.7 cm x 31.1 cm x 72.4 cm	71.9 L	13.9 kg		4

^aNot for sale in California.

Step-On Containers

Step-On Containers are the smart choice for large-capacity, hands-free waste collection. Attractive design is suitable for front- and back-of-house applications.

- Stainless steel provides a clean, modern appearance
- Available in 23-gallon and 30-gallon capacities for improved productivity
- Slow-closing lid with integrated damper reduces noise
- Extra-large foot pedal is easy to operate while carrying large loads
- Assists in complying with OSHA regulation 29 CFR 1910.1030 "Occupational Exposure to Bloodborne Pathogens"
- Metal bag straps keep can liners securely in place



OSHA



FG614700



FG614787



FG630000
(Bag shown not included)

FG614687



FG614700



QUIET, SLOW-CLOSE LID

Integrated lid damper reduces excessive noise and helps keep odors and bacteria from escaping.



CAN LINER RETAINING STRAPS

Metal retaining straps keep can liners securely in place and out of sight during use.



QUIET CASTERS

Rubbermaid's red Quiet Casters ensure smooth, quiet operation.



EXTRA-LARGE FOOT PEDAL

Large foot pedal provides hands-free, hygienic disposal.

No.	Color	Description	U.S. Dimensions	U.S. Capacity	U.S. Ship Wt/Ctn	Metric Dimensions	Metric Capacity	Metric Ship Wt/Ctn	Pack
FG614687	RED, BLA	23-Gallon Stainless Steel Step-On Container	22.25" l x 20.38" w x 27.5" h	23 gal	18.8 lb	56.5 cm x 51.8 cm x 69.9 cm	87.1 L	8.5 kg	1
FG614700	RED, LPLAT	30-Gallon Step-On Container	24.25" l x 19.75" w x 34.25" h	30 gal	18.8 lb	61.6 cm x 50.2 cm x 87 cm	113.6 L	8.5 kg	1
FG614787	RED, BLA	30-Gallon Stainless Steel Step-On Container	22.75" l x 20.38" w x 34.25" h	30 gal	21.8 lb	57.8 cm x 51.8 cm x 87 cm	113.6 L	9.9 kg	1
FG630000	BLA	Premium Linen Hamper (uses 30-Gallon Can Liner)	22.25" l x 20.38" w x 37.88" h	N/A	14.8 lb	56.5 cm x 51.8 cm x 96.2 cm	N/A	6.7 kg	1
FG635000	BLA	Premium Linen Hamper Bag	19.88" l x 13.38" w x 29.25" h	30 gal	2.8 lb	50.5 cm x 34 cm x 74.3 cm	113.6 L	1.3 kg	1

WHEN ORDERING PRODUCTS WITH BOLD COLOR CODES, PLEASE SPECIFY COLOR CODE AFTER THE PRODUCT NUMBER. REFER TO THE PRODUCT COLOR GUIDE AT THE BACK OF THE CATALOG.

The Defenders®

The Defenders® Medical Step Cans comply with OSHA standards on bloodborne pathogens for the safe containment of infectious waste. Meets Federal OBRA regulations.

- All models constructed of fire-safe, heavy-gauge galvanized steel or nonmagnetic stainless steel

Square Containers

- Self-closing piano-hinge lid
- Retainer bands hold can liners securely inside or use with available leak-proof rigid plastic liner
- Restraint mechanism protects walls and equipment
- Steel legs with nonslip buttons protect floors

Round Containers

- Nonmagnetic stainless steel
- Vinyl base ring protects floors
- Choice of galvanized steel or leak-proof rigid plastic liner



Folding retainer bands hold can liner neatly inside.



Step Cans may be customized.

No.	Liner	Color	Description	Capacity (Gal)	Capacity (Liters)	U.S. Dimensions	U.S. Ship Wt/Ctn	Metric Dimensions	Metric Ship Wt/Ctn																																																																																																																																																																		
FGST35E	GL ^Ø	RD, WH	The Defenders® Step Can	3.5	13.2	11" dia x 17" h	8.0 lb	27.9 cm dia x 43.2 cm	3.6 kg																																																																																																																																																																		
	PL [⌘]	RD, WH		3.5	13.2					FGST35	GL ^Ø	SS	The Defenders® Step Can	3.5	13.2	11" dia x 17" h	8.0 lb	27.9 cm dia x 43.2 cm	3.6 kg	PL [⌘]	SS	3.5	13.2	FGST5E	GL ^Ø	RD, WH	The Defenders® Step Can	5	18.9	11" dia x 22" h	10.0 lb	27.9 cm dia x 55.9 cm	4.5 kg	PL [⌘]	RD, WH	7	26.5	FGST7	RB ^Ø	SS	The Defenders® Step Can	7	26.5	12" sq x 17" h	16.0 lb	30.5 cm sq x 43.2 cm	7.3 kg	PL [⌘]	SS	7	26.5	FGST7E	RB ^Ø	RD, WH	The Defenders® Step Can	7	26.5	12" sq x 17" h	16.0 lb	30.5 cm sq x 43.2 cm	7.3 kg	PL [⌘]	RD, WH	7	26.5	FGST12	RB ^Ø	SS	The Defenders® Step Can	12	45.4	12" sq x 23" h	20.0 lb	30.5 cm sq x 58.4 cm	9.1 kg	PL [⌘]	SS	12	45.4	FGST12E	RB ^Ø	RD, WH	The Defenders® Step Can	12	45.4	12" sq x 23" h	20.0 lb	30.5 cm sq x 58.4 cm	9.1 kg	PL [⌘]	RD, WH	12	45.4	FGST24	RB ^Ø	SS	The Defenders® Step Can	24	90.8	15" sq x 30" h	26.0 lb	38.1 cm sq x 76.2 cm	11.8 kg	PL [⌘]	SS	24	90.8	FGST24E	RB ^Ø	RD, WH	The Defenders® Step Can	24	90.8	15" sq x 30" h	26.0 lb	38.1 cm sq x 76.2 cm	11.8 kg	PL [⌘]	RD, WH	24	90.8	FGST40	RB ^Ø	SS	The Defenders® Step Can w/ Wheels	40	151.4	19" sq x 30" h	44.0 lb	48.3 cm sq x 76.2 cm	20 kg	PL [⌘]	SS	40	151.4	FGST40E	RB ^Ø	RD, WH	The Defenders® Step Can	40	151.4	19" sq x 30" h	37.0 lb	48.3 cm sq x 76.2 cm	16.8 kg	PL [⌘]	RD, WH	40	151.4	FGST40EW	RB ^Ø	RD, WH	The Defenders® Step Can w/ Wheels	40	151.4	19" sq x 30" h	41.0 lb	48.3 cm sq x 76.2 cm	18.6 kg	PL [⌘]	RD, WH	40	151.4	FGST40SW	RB ^Ø	SS	The Defenders® Step Can w/ Wheels	40	151.4	19" sq x 30" h	44.0 lb
FGST35	GL ^Ø	SS	The Defenders® Step Can	3.5	13.2	11" dia x 17" h	8.0 lb	27.9 cm dia x 43.2 cm	3.6 kg																																																																																																																																																																		
	PL [⌘]	SS		3.5	13.2					FGST5E	GL ^Ø	RD, WH	The Defenders® Step Can	5	18.9	11" dia x 22" h	10.0 lb	27.9 cm dia x 55.9 cm	4.5 kg	PL [⌘]	RD, WH	7	26.5	FGST7	RB ^Ø	SS	The Defenders® Step Can	7	26.5	12" sq x 17" h	16.0 lb	30.5 cm sq x 43.2 cm	7.3 kg	PL [⌘]	SS	7	26.5	FGST7E	RB ^Ø	RD, WH	The Defenders® Step Can	7	26.5	12" sq x 17" h	16.0 lb	30.5 cm sq x 43.2 cm	7.3 kg	PL [⌘]	RD, WH	7	26.5	FGST12	RB ^Ø	SS	The Defenders® Step Can	12	45.4	12" sq x 23" h	20.0 lb	30.5 cm sq x 58.4 cm	9.1 kg	PL [⌘]	SS	12	45.4	FGST12E	RB ^Ø	RD, WH	The Defenders® Step Can	12	45.4	12" sq x 23" h	20.0 lb	30.5 cm sq x 58.4 cm	9.1 kg	PL [⌘]	RD, WH	12	45.4	FGST24	RB ^Ø	SS	The Defenders® Step Can	24	90.8	15" sq x 30" h	26.0 lb	38.1 cm sq x 76.2 cm	11.8 kg	PL [⌘]	SS	24	90.8	FGST24E	RB ^Ø	RD, WH	The Defenders® Step Can	24	90.8	15" sq x 30" h	26.0 lb	38.1 cm sq x 76.2 cm	11.8 kg	PL [⌘]	RD, WH	24	90.8	FGST40	RB ^Ø	SS	The Defenders® Step Can w/ Wheels	40	151.4	19" sq x 30" h	44.0 lb	48.3 cm sq x 76.2 cm	20 kg	PL [⌘]	SS	40	151.4	FGST40E	RB ^Ø	RD, WH	The Defenders® Step Can	40	151.4	19" sq x 30" h	37.0 lb	48.3 cm sq x 76.2 cm	16.8 kg	PL [⌘]	RD, WH	40	151.4	FGST40EW	RB ^Ø	RD, WH	The Defenders® Step Can w/ Wheels	40	151.4	19" sq x 30" h	41.0 lb	48.3 cm sq x 76.2 cm	18.6 kg	PL [⌘]	RD, WH	40	151.4	FGST40SW	RB ^Ø	SS	The Defenders® Step Can w/ Wheels	40	151.4	19" sq x 30" h	44.0 lb	48.3 cm sq x 76.2 cm	20 kg	PL [⌘]	SS	40	151.4								
FGST5E	GL ^Ø	RD, WH	The Defenders® Step Can	5	18.9	11" dia x 22" h	10.0 lb	27.9 cm dia x 55.9 cm	4.5 kg																																																																																																																																																																		
	PL [⌘]	RD, WH		7	26.5					FGST7	RB ^Ø	SS	The Defenders® Step Can	7	26.5	12" sq x 17" h	16.0 lb	30.5 cm sq x 43.2 cm	7.3 kg	PL [⌘]	SS	7	26.5	FGST7E	RB ^Ø	RD, WH	The Defenders® Step Can	7	26.5	12" sq x 17" h	16.0 lb	30.5 cm sq x 43.2 cm	7.3 kg	PL [⌘]	RD, WH	7	26.5	FGST12	RB ^Ø	SS	The Defenders® Step Can	12	45.4	12" sq x 23" h	20.0 lb	30.5 cm sq x 58.4 cm	9.1 kg	PL [⌘]	SS	12	45.4	FGST12E	RB ^Ø	RD, WH	The Defenders® Step Can	12	45.4	12" sq x 23" h	20.0 lb	30.5 cm sq x 58.4 cm	9.1 kg	PL [⌘]	RD, WH	12	45.4	FGST24	RB ^Ø	SS	The Defenders® Step Can	24	90.8	15" sq x 30" h	26.0 lb	38.1 cm sq x 76.2 cm	11.8 kg	PL [⌘]	SS	24	90.8	FGST24E	RB ^Ø	RD, WH	The Defenders® Step Can	24	90.8	15" sq x 30" h	26.0 lb	38.1 cm sq x 76.2 cm	11.8 kg	PL [⌘]	RD, WH	24	90.8	FGST40	RB ^Ø	SS	The Defenders® Step Can w/ Wheels	40	151.4	19" sq x 30" h	44.0 lb	48.3 cm sq x 76.2 cm	20 kg	PL [⌘]	SS	40	151.4	FGST40E	RB ^Ø	RD, WH	The Defenders® Step Can	40	151.4	19" sq x 30" h	37.0 lb	48.3 cm sq x 76.2 cm	16.8 kg	PL [⌘]	RD, WH	40	151.4	FGST40EW	RB ^Ø	RD, WH	The Defenders® Step Can w/ Wheels	40	151.4	19" sq x 30" h	41.0 lb	48.3 cm sq x 76.2 cm	18.6 kg	PL [⌘]	RD, WH	40	151.4	FGST40SW	RB ^Ø	SS	The Defenders® Step Can w/ Wheels	40	151.4	19" sq x 30" h	44.0 lb	48.3 cm sq x 76.2 cm	20 kg	PL [⌘]	SS	40	151.4																						
FGST7	RB ^Ø	SS	The Defenders® Step Can	7	26.5	12" sq x 17" h	16.0 lb	30.5 cm sq x 43.2 cm	7.3 kg																																																																																																																																																																		
	PL [⌘]	SS		7	26.5					FGST7E	RB ^Ø	RD, WH	The Defenders® Step Can	7	26.5	12" sq x 17" h	16.0 lb	30.5 cm sq x 43.2 cm	7.3 kg	PL [⌘]	RD, WH	7	26.5	FGST12	RB ^Ø	SS	The Defenders® Step Can	12	45.4	12" sq x 23" h	20.0 lb	30.5 cm sq x 58.4 cm	9.1 kg	PL [⌘]	SS	12	45.4	FGST12E	RB ^Ø	RD, WH	The Defenders® Step Can	12	45.4	12" sq x 23" h	20.0 lb	30.5 cm sq x 58.4 cm	9.1 kg	PL [⌘]	RD, WH	12	45.4	FGST24	RB ^Ø	SS	The Defenders® Step Can	24	90.8	15" sq x 30" h	26.0 lb	38.1 cm sq x 76.2 cm	11.8 kg	PL [⌘]	SS	24	90.8	FGST24E	RB ^Ø	RD, WH	The Defenders® Step Can	24	90.8	15" sq x 30" h	26.0 lb	38.1 cm sq x 76.2 cm	11.8 kg	PL [⌘]	RD, WH	24	90.8	FGST40	RB ^Ø	SS	The Defenders® Step Can w/ Wheels	40	151.4	19" sq x 30" h	44.0 lb	48.3 cm sq x 76.2 cm	20 kg	PL [⌘]	SS	40	151.4	FGST40E	RB ^Ø	RD, WH	The Defenders® Step Can	40	151.4	19" sq x 30" h	37.0 lb	48.3 cm sq x 76.2 cm	16.8 kg	PL [⌘]	RD, WH	40	151.4	FGST40EW	RB ^Ø	RD, WH	The Defenders® Step Can w/ Wheels	40	151.4	19" sq x 30" h	41.0 lb	48.3 cm sq x 76.2 cm	18.6 kg	PL [⌘]	RD, WH	40	151.4	FGST40SW	RB ^Ø	SS	The Defenders® Step Can w/ Wheels	40	151.4	19" sq x 30" h	44.0 lb	48.3 cm sq x 76.2 cm	20 kg	PL [⌘]	SS	40	151.4																																				
FGST7E	RB ^Ø	RD, WH	The Defenders® Step Can	7	26.5	12" sq x 17" h	16.0 lb	30.5 cm sq x 43.2 cm	7.3 kg																																																																																																																																																																		
	PL [⌘]	RD, WH		7	26.5					FGST12	RB ^Ø	SS	The Defenders® Step Can	12	45.4	12" sq x 23" h	20.0 lb	30.5 cm sq x 58.4 cm	9.1 kg	PL [⌘]	SS	12	45.4	FGST12E	RB ^Ø	RD, WH	The Defenders® Step Can	12	45.4	12" sq x 23" h	20.0 lb	30.5 cm sq x 58.4 cm	9.1 kg	PL [⌘]	RD, WH	12	45.4	FGST24	RB ^Ø	SS	The Defenders® Step Can	24	90.8	15" sq x 30" h	26.0 lb	38.1 cm sq x 76.2 cm	11.8 kg	PL [⌘]	SS	24	90.8	FGST24E	RB ^Ø	RD, WH	The Defenders® Step Can	24	90.8	15" sq x 30" h	26.0 lb	38.1 cm sq x 76.2 cm	11.8 kg	PL [⌘]	RD, WH	24	90.8	FGST40	RB ^Ø	SS	The Defenders® Step Can w/ Wheels	40	151.4	19" sq x 30" h	44.0 lb	48.3 cm sq x 76.2 cm	20 kg	PL [⌘]	SS	40	151.4	FGST40E	RB ^Ø	RD, WH	The Defenders® Step Can	40	151.4	19" sq x 30" h	37.0 lb	48.3 cm sq x 76.2 cm	16.8 kg	PL [⌘]	RD, WH	40	151.4	FGST40EW	RB ^Ø	RD, WH	The Defenders® Step Can w/ Wheels	40	151.4	19" sq x 30" h	41.0 lb	48.3 cm sq x 76.2 cm	18.6 kg	PL [⌘]	RD, WH	40	151.4	FGST40SW	RB ^Ø	SS	The Defenders® Step Can w/ Wheels	40	151.4	19" sq x 30" h	44.0 lb	48.3 cm sq x 76.2 cm	20 kg	PL [⌘]	SS	40	151.4																																																		
FGST12	RB ^Ø	SS	The Defenders® Step Can	12	45.4	12" sq x 23" h	20.0 lb	30.5 cm sq x 58.4 cm	9.1 kg																																																																																																																																																																		
	PL [⌘]	SS		12	45.4					FGST12E	RB ^Ø	RD, WH	The Defenders® Step Can	12	45.4	12" sq x 23" h	20.0 lb	30.5 cm sq x 58.4 cm	9.1 kg	PL [⌘]	RD, WH	12	45.4	FGST24	RB ^Ø	SS	The Defenders® Step Can	24	90.8	15" sq x 30" h	26.0 lb	38.1 cm sq x 76.2 cm	11.8 kg	PL [⌘]	SS	24	90.8	FGST24E	RB ^Ø	RD, WH	The Defenders® Step Can	24	90.8	15" sq x 30" h	26.0 lb	38.1 cm sq x 76.2 cm	11.8 kg	PL [⌘]	RD, WH	24	90.8	FGST40	RB ^Ø	SS	The Defenders® Step Can w/ Wheels	40	151.4	19" sq x 30" h	44.0 lb	48.3 cm sq x 76.2 cm	20 kg	PL [⌘]	SS	40	151.4	FGST40E	RB ^Ø	RD, WH	The Defenders® Step Can	40	151.4	19" sq x 30" h	37.0 lb	48.3 cm sq x 76.2 cm	16.8 kg	PL [⌘]	RD, WH	40	151.4	FGST40EW	RB ^Ø	RD, WH	The Defenders® Step Can w/ Wheels	40	151.4	19" sq x 30" h	41.0 lb	48.3 cm sq x 76.2 cm	18.6 kg	PL [⌘]	RD, WH	40	151.4	FGST40SW	RB ^Ø	SS	The Defenders® Step Can w/ Wheels	40	151.4	19" sq x 30" h	44.0 lb	48.3 cm sq x 76.2 cm	20 kg	PL [⌘]	SS	40	151.4																																																																
FGST12E	RB ^Ø	RD, WH	The Defenders® Step Can	12	45.4	12" sq x 23" h	20.0 lb	30.5 cm sq x 58.4 cm	9.1 kg																																																																																																																																																																		
	PL [⌘]	RD, WH		12	45.4					FGST24	RB ^Ø	SS	The Defenders® Step Can	24	90.8	15" sq x 30" h	26.0 lb	38.1 cm sq x 76.2 cm	11.8 kg	PL [⌘]	SS	24	90.8	FGST24E	RB ^Ø	RD, WH	The Defenders® Step Can	24	90.8	15" sq x 30" h	26.0 lb	38.1 cm sq x 76.2 cm	11.8 kg	PL [⌘]	RD, WH	24	90.8	FGST40	RB ^Ø	SS	The Defenders® Step Can w/ Wheels	40	151.4	19" sq x 30" h	44.0 lb	48.3 cm sq x 76.2 cm	20 kg	PL [⌘]	SS	40	151.4	FGST40E	RB ^Ø	RD, WH	The Defenders® Step Can	40	151.4	19" sq x 30" h	37.0 lb	48.3 cm sq x 76.2 cm	16.8 kg	PL [⌘]	RD, WH	40	151.4	FGST40EW	RB ^Ø	RD, WH	The Defenders® Step Can w/ Wheels	40	151.4	19" sq x 30" h	41.0 lb	48.3 cm sq x 76.2 cm	18.6 kg	PL [⌘]	RD, WH	40	151.4	FGST40SW	RB ^Ø	SS	The Defenders® Step Can w/ Wheels	40	151.4	19" sq x 30" h	44.0 lb	48.3 cm sq x 76.2 cm	20 kg	PL [⌘]	SS	40	151.4																																																																														
FGST24	RB ^Ø	SS	The Defenders® Step Can	24	90.8	15" sq x 30" h	26.0 lb	38.1 cm sq x 76.2 cm	11.8 kg																																																																																																																																																																		
	PL [⌘]	SS		24	90.8					FGST24E	RB ^Ø	RD, WH	The Defenders® Step Can	24	90.8	15" sq x 30" h	26.0 lb	38.1 cm sq x 76.2 cm	11.8 kg	PL [⌘]	RD, WH	24	90.8	FGST40	RB ^Ø	SS	The Defenders® Step Can w/ Wheels	40	151.4	19" sq x 30" h	44.0 lb	48.3 cm sq x 76.2 cm	20 kg	PL [⌘]	SS	40	151.4	FGST40E	RB ^Ø	RD, WH	The Defenders® Step Can	40	151.4	19" sq x 30" h	37.0 lb	48.3 cm sq x 76.2 cm	16.8 kg	PL [⌘]	RD, WH	40	151.4	FGST40EW	RB ^Ø	RD, WH	The Defenders® Step Can w/ Wheels	40	151.4	19" sq x 30" h	41.0 lb	48.3 cm sq x 76.2 cm	18.6 kg	PL [⌘]	RD, WH	40	151.4	FGST40SW	RB ^Ø	SS	The Defenders® Step Can w/ Wheels	40	151.4	19" sq x 30" h	44.0 lb	48.3 cm sq x 76.2 cm	20 kg	PL [⌘]	SS	40	151.4																																																																																												
FGST24E	RB ^Ø	RD, WH	The Defenders® Step Can	24	90.8	15" sq x 30" h	26.0 lb	38.1 cm sq x 76.2 cm	11.8 kg																																																																																																																																																																		
	PL [⌘]	RD, WH		24	90.8					FGST40	RB ^Ø	SS	The Defenders® Step Can w/ Wheels	40	151.4	19" sq x 30" h	44.0 lb	48.3 cm sq x 76.2 cm	20 kg	PL [⌘]	SS	40	151.4	FGST40E	RB ^Ø	RD, WH	The Defenders® Step Can	40	151.4	19" sq x 30" h	37.0 lb	48.3 cm sq x 76.2 cm	16.8 kg	PL [⌘]	RD, WH	40	151.4	FGST40EW	RB ^Ø	RD, WH	The Defenders® Step Can w/ Wheels	40	151.4	19" sq x 30" h	41.0 lb	48.3 cm sq x 76.2 cm	18.6 kg	PL [⌘]	RD, WH	40	151.4	FGST40SW	RB ^Ø	SS	The Defenders® Step Can w/ Wheels	40	151.4	19" sq x 30" h	44.0 lb	48.3 cm sq x 76.2 cm	20 kg	PL [⌘]	SS	40	151.4																																																																																																										
FGST40	RB ^Ø	SS	The Defenders® Step Can w/ Wheels	40	151.4	19" sq x 30" h	44.0 lb	48.3 cm sq x 76.2 cm	20 kg																																																																																																																																																																		
	PL [⌘]	SS		40	151.4					FGST40E	RB ^Ø	RD, WH	The Defenders® Step Can	40	151.4	19" sq x 30" h	37.0 lb	48.3 cm sq x 76.2 cm	16.8 kg	PL [⌘]	RD, WH	40	151.4	FGST40EW	RB ^Ø	RD, WH	The Defenders® Step Can w/ Wheels	40	151.4	19" sq x 30" h	41.0 lb	48.3 cm sq x 76.2 cm	18.6 kg	PL [⌘]	RD, WH	40	151.4	FGST40SW	RB ^Ø	SS	The Defenders® Step Can w/ Wheels	40	151.4	19" sq x 30" h	44.0 lb	48.3 cm sq x 76.2 cm	20 kg	PL [⌘]	SS	40	151.4																																																																																																																								
FGST40E	RB ^Ø	RD, WH	The Defenders® Step Can	40	151.4	19" sq x 30" h	37.0 lb	48.3 cm sq x 76.2 cm	16.8 kg																																																																																																																																																																		
	PL [⌘]	RD, WH		40	151.4					FGST40EW	RB ^Ø	RD, WH	The Defenders® Step Can w/ Wheels	40	151.4	19" sq x 30" h	41.0 lb	48.3 cm sq x 76.2 cm	18.6 kg	PL [⌘]	RD, WH	40	151.4	FGST40SW	RB ^Ø	SS	The Defenders® Step Can w/ Wheels	40	151.4	19" sq x 30" h	44.0 lb	48.3 cm sq x 76.2 cm	20 kg	PL [⌘]	SS	40	151.4																																																																																																																																						
FGST40EW	RB ^Ø	RD, WH	The Defenders® Step Can w/ Wheels	40	151.4	19" sq x 30" h	41.0 lb	48.3 cm sq x 76.2 cm	18.6 kg																																																																																																																																																																		
	PL [⌘]	RD, WH		40	151.4					FGST40SW	RB ^Ø	SS	The Defenders® Step Can w/ Wheels	40	151.4	19" sq x 30" h	44.0 lb	48.3 cm sq x 76.2 cm	20 kg	PL [⌘]	SS	40	151.4																																																																																																																																																				
FGST40SW	RB ^Ø	SS	The Defenders® Step Can w/ Wheels	40	151.4	19" sq x 30" h	44.0 lb	48.3 cm sq x 76.2 cm	20 kg																																																																																																																																																																		
	PL [⌘]	SS		40	151.4																																																																																																																																																																						

Galvanized Liner (GL), Retainer Bands Only (RB), Plastic Liner (PL) ^Ø UL-Listed, FM, CSFM [⌘] UL-Listed, FM
 Red (RD), White (WH), Stainless Steel (SS) See pgs 286–287 for custom labeling options. Call Customer Service for pricing.

The Silent Defenders®

Damper-controlled lid closes without a sound. Ideal for anywhere a quiet environment is desired.

- Heavy-duty institutional quality steel step cans
- Self-closing piano-hinge lid
- Folding retainer bands hold can liners securely inside
- Nonmagnetic stainless steel
- Perfect for medical facilities



DAMPER-CONTROLLED LID
Closes without a sound.



FGQST40ESS

FGQST7SSPL

FGQST12EWH

OSHA



No.	Liner	Color	Description	Capacity (Gal)	Capacity (Liters)	U.S. Dimensions	U.S. Ship Wt/Ctn	Metric Dimensions	Metric Ship Wt/Ctn																																																																																																																								
FGQST7E	RB	RD, WH	The Silent Defenders® Quiet Step Can	7	26.5	12" sq x 17" h	17.0 lb	30.5 cm sq x 43.2 cm	7.7 kg																																																																																																																								
	PL	RD, WH		7	26.5					FGQST7	RB	SS	The Silent Defenders® Quiet Step Can	7	26.5	12" sq x 17" h	17.0 lb	30.5 cm sq x 43.2 cm	7.7 kg	PL	SS	7	26.5	FGQST12	RB	SS	The Silent Defenders® Quiet Step Can	12	45.4	12" sq x 23" h	20.0 lb	30.5 cm sq x 58.4 cm	9.1 kg	PL	SS	12	45.4	FGQST12E	RB	RD, WH	The Silent Defenders® Quiet Step Can	12	45.4	12" sq x 23" h	20.0 lb	30.5 cm sq x 58.4 cm	9.1 kg	PL	RD, WH	12	45.4	FGQST24	RB	SS	The Silent Defenders® Quiet Step Can	24	90.8	15" sq x 30" h	26.0 lb	38.1 cm sq x 76.2 cm	11.8 kg	PL	SS	24	90.8	FGQST24E	RB	RD, WH	The Silent Defenders® Quiet Step Can	24	90.8	15" sq x 30" h	26.0 lb	38.1 cm sq x 76.2 cm	11.8 kg	PL	RD, WH	24	90.8	FGQST40	RB	SS	The Silent Defenders® Quiet Step Can	40	151.4	19" sq x 30" h	45.0 lb	48.3 cm sq x 76.2 cm	20.4 kg	PL	SS	40	151.4	FGQST40E	RB	RD, WH	The Silent Defenders® Quiet Step Can	40	151.4	19" sq x 30" h	37.0 lb	48.3 cm sq x 76.2 cm	16.8 kg	PL	RD, WH	40	151.4	FGQST40EW	RB	RD, WH	The Silent Defenders® Quiet Step Can w/ Wheels	40	151.4	19" sq x 30" h	43.0 lb	48.3 cm sq x 76.2 cm	19.5 kg	PL	RD, WH	40	151.4	FGQST40SW	RB	SS	The Silent Defenders® Quiet Step Can w/ Wheels	40	151.4	19" sq x 30" h	45.0 lb
FGQST7	RB	SS	The Silent Defenders® Quiet Step Can	7	26.5	12" sq x 17" h	17.0 lb	30.5 cm sq x 43.2 cm	7.7 kg																																																																																																																								
	PL	SS		7	26.5					FGQST12	RB	SS	The Silent Defenders® Quiet Step Can	12	45.4	12" sq x 23" h	20.0 lb	30.5 cm sq x 58.4 cm	9.1 kg	PL	SS	12	45.4	FGQST12E	RB	RD, WH	The Silent Defenders® Quiet Step Can	12	45.4	12" sq x 23" h	20.0 lb	30.5 cm sq x 58.4 cm	9.1 kg	PL	RD, WH	12	45.4	FGQST24	RB	SS	The Silent Defenders® Quiet Step Can	24	90.8	15" sq x 30" h	26.0 lb	38.1 cm sq x 76.2 cm	11.8 kg	PL	SS	24	90.8	FGQST24E	RB	RD, WH	The Silent Defenders® Quiet Step Can	24	90.8	15" sq x 30" h	26.0 lb	38.1 cm sq x 76.2 cm	11.8 kg	PL	RD, WH	24	90.8	FGQST40	RB	SS	The Silent Defenders® Quiet Step Can	40	151.4	19" sq x 30" h	45.0 lb	48.3 cm sq x 76.2 cm	20.4 kg	PL	SS	40	151.4	FGQST40E	RB	RD, WH	The Silent Defenders® Quiet Step Can	40	151.4	19" sq x 30" h	37.0 lb	48.3 cm sq x 76.2 cm	16.8 kg	PL	RD, WH	40	151.4	FGQST40EW	RB	RD, WH	The Silent Defenders® Quiet Step Can w/ Wheels	40	151.4	19" sq x 30" h	43.0 lb	48.3 cm sq x 76.2 cm	19.5 kg	PL	RD, WH	40	151.4	FGQST40SW	RB	SS	The Silent Defenders® Quiet Step Can w/ Wheels	40	151.4	19" sq x 30" h	45.0 lb	48.3 cm sq x 76.2 cm	20.4 kg	PL	SS	40	151.4								
FGQST12	RB	SS	The Silent Defenders® Quiet Step Can	12	45.4	12" sq x 23" h	20.0 lb	30.5 cm sq x 58.4 cm	9.1 kg																																																																																																																								
	PL	SS		12	45.4					FGQST12E	RB	RD, WH	The Silent Defenders® Quiet Step Can	12	45.4	12" sq x 23" h	20.0 lb	30.5 cm sq x 58.4 cm	9.1 kg	PL	RD, WH	12	45.4	FGQST24	RB	SS	The Silent Defenders® Quiet Step Can	24	90.8	15" sq x 30" h	26.0 lb	38.1 cm sq x 76.2 cm	11.8 kg	PL	SS	24	90.8	FGQST24E	RB	RD, WH	The Silent Defenders® Quiet Step Can	24	90.8	15" sq x 30" h	26.0 lb	38.1 cm sq x 76.2 cm	11.8 kg	PL	RD, WH	24	90.8	FGQST40	RB	SS	The Silent Defenders® Quiet Step Can	40	151.4	19" sq x 30" h	45.0 lb	48.3 cm sq x 76.2 cm	20.4 kg	PL	SS	40	151.4	FGQST40E	RB	RD, WH	The Silent Defenders® Quiet Step Can	40	151.4	19" sq x 30" h	37.0 lb	48.3 cm sq x 76.2 cm	16.8 kg	PL	RD, WH	40	151.4	FGQST40EW	RB	RD, WH	The Silent Defenders® Quiet Step Can w/ Wheels	40	151.4	19" sq x 30" h	43.0 lb	48.3 cm sq x 76.2 cm	19.5 kg	PL	RD, WH	40	151.4	FGQST40SW	RB	SS	The Silent Defenders® Quiet Step Can w/ Wheels	40	151.4	19" sq x 30" h	45.0 lb	48.3 cm sq x 76.2 cm	20.4 kg	PL	SS	40	151.4																						
FGQST12E	RB	RD, WH	The Silent Defenders® Quiet Step Can	12	45.4	12" sq x 23" h	20.0 lb	30.5 cm sq x 58.4 cm	9.1 kg																																																																																																																								
	PL	RD, WH		12	45.4					FGQST24	RB	SS	The Silent Defenders® Quiet Step Can	24	90.8	15" sq x 30" h	26.0 lb	38.1 cm sq x 76.2 cm	11.8 kg	PL	SS	24	90.8	FGQST24E	RB	RD, WH	The Silent Defenders® Quiet Step Can	24	90.8	15" sq x 30" h	26.0 lb	38.1 cm sq x 76.2 cm	11.8 kg	PL	RD, WH	24	90.8	FGQST40	RB	SS	The Silent Defenders® Quiet Step Can	40	151.4	19" sq x 30" h	45.0 lb	48.3 cm sq x 76.2 cm	20.4 kg	PL	SS	40	151.4	FGQST40E	RB	RD, WH	The Silent Defenders® Quiet Step Can	40	151.4	19" sq x 30" h	37.0 lb	48.3 cm sq x 76.2 cm	16.8 kg	PL	RD, WH	40	151.4	FGQST40EW	RB	RD, WH	The Silent Defenders® Quiet Step Can w/ Wheels	40	151.4	19" sq x 30" h	43.0 lb	48.3 cm sq x 76.2 cm	19.5 kg	PL	RD, WH	40	151.4	FGQST40SW	RB	SS	The Silent Defenders® Quiet Step Can w/ Wheels	40	151.4	19" sq x 30" h	45.0 lb	48.3 cm sq x 76.2 cm	20.4 kg	PL	SS	40	151.4																																				
FGQST24	RB	SS	The Silent Defenders® Quiet Step Can	24	90.8	15" sq x 30" h	26.0 lb	38.1 cm sq x 76.2 cm	11.8 kg																																																																																																																								
	PL	SS		24	90.8					FGQST24E	RB	RD, WH	The Silent Defenders® Quiet Step Can	24	90.8	15" sq x 30" h	26.0 lb	38.1 cm sq x 76.2 cm	11.8 kg	PL	RD, WH	24	90.8	FGQST40	RB	SS	The Silent Defenders® Quiet Step Can	40	151.4	19" sq x 30" h	45.0 lb	48.3 cm sq x 76.2 cm	20.4 kg	PL	SS	40	151.4	FGQST40E	RB	RD, WH	The Silent Defenders® Quiet Step Can	40	151.4	19" sq x 30" h	37.0 lb	48.3 cm sq x 76.2 cm	16.8 kg	PL	RD, WH	40	151.4	FGQST40EW	RB	RD, WH	The Silent Defenders® Quiet Step Can w/ Wheels	40	151.4	19" sq x 30" h	43.0 lb	48.3 cm sq x 76.2 cm	19.5 kg	PL	RD, WH	40	151.4	FGQST40SW	RB	SS	The Silent Defenders® Quiet Step Can w/ Wheels	40	151.4	19" sq x 30" h	45.0 lb	48.3 cm sq x 76.2 cm	20.4 kg	PL	SS	40	151.4																																																		
FGQST24E	RB	RD, WH	The Silent Defenders® Quiet Step Can	24	90.8	15" sq x 30" h	26.0 lb	38.1 cm sq x 76.2 cm	11.8 kg																																																																																																																								
	PL	RD, WH		24	90.8					FGQST40	RB	SS	The Silent Defenders® Quiet Step Can	40	151.4	19" sq x 30" h	45.0 lb	48.3 cm sq x 76.2 cm	20.4 kg	PL	SS	40	151.4	FGQST40E	RB	RD, WH	The Silent Defenders® Quiet Step Can	40	151.4	19" sq x 30" h	37.0 lb	48.3 cm sq x 76.2 cm	16.8 kg	PL	RD, WH	40	151.4	FGQST40EW	RB	RD, WH	The Silent Defenders® Quiet Step Can w/ Wheels	40	151.4	19" sq x 30" h	43.0 lb	48.3 cm sq x 76.2 cm	19.5 kg	PL	RD, WH	40	151.4	FGQST40SW	RB	SS	The Silent Defenders® Quiet Step Can w/ Wheels	40	151.4	19" sq x 30" h	45.0 lb	48.3 cm sq x 76.2 cm	20.4 kg	PL	SS	40	151.4																																																																
FGQST40	RB	SS	The Silent Defenders® Quiet Step Can	40	151.4	19" sq x 30" h	45.0 lb	48.3 cm sq x 76.2 cm	20.4 kg																																																																																																																								
	PL	SS		40	151.4					FGQST40E	RB	RD, WH	The Silent Defenders® Quiet Step Can	40	151.4	19" sq x 30" h	37.0 lb	48.3 cm sq x 76.2 cm	16.8 kg	PL	RD, WH	40	151.4	FGQST40EW	RB	RD, WH	The Silent Defenders® Quiet Step Can w/ Wheels	40	151.4	19" sq x 30" h	43.0 lb	48.3 cm sq x 76.2 cm	19.5 kg	PL	RD, WH	40	151.4	FGQST40SW	RB	SS	The Silent Defenders® Quiet Step Can w/ Wheels	40	151.4	19" sq x 30" h	45.0 lb	48.3 cm sq x 76.2 cm	20.4 kg	PL	SS	40	151.4																																																																														
FGQST40E	RB	RD, WH	The Silent Defenders® Quiet Step Can	40	151.4	19" sq x 30" h	37.0 lb	48.3 cm sq x 76.2 cm	16.8 kg																																																																																																																								
	PL	RD, WH		40	151.4					FGQST40EW	RB	RD, WH	The Silent Defenders® Quiet Step Can w/ Wheels	40	151.4	19" sq x 30" h	43.0 lb	48.3 cm sq x 76.2 cm	19.5 kg	PL	RD, WH	40	151.4	FGQST40SW	RB	SS	The Silent Defenders® Quiet Step Can w/ Wheels	40	151.4	19" sq x 30" h	45.0 lb	48.3 cm sq x 76.2 cm	20.4 kg	PL	SS	40	151.4																																																																																												
FGQST40EW	RB	RD, WH	The Silent Defenders® Quiet Step Can w/ Wheels	40	151.4	19" sq x 30" h	43.0 lb	48.3 cm sq x 76.2 cm	19.5 kg																																																																																																																								
	PL	RD, WH		40	151.4					FGQST40SW	RB	SS	The Silent Defenders® Quiet Step Can w/ Wheels	40	151.4	19" sq x 30" h	45.0 lb	48.3 cm sq x 76.2 cm	20.4 kg	PL	SS	40	151.4																																																																																																										
FGQST40SW	RB	SS	The Silent Defenders® Quiet Step Can w/ Wheels	40	151.4	19" sq x 30" h	45.0 lb	48.3 cm sq x 76.2 cm	20.4 kg																																																																																																																								
	PL	SS		40	151.4																																																																																																																												

Retainer Bands Only (RB), Plastic Liner (PL) Red (RD), Stainless Steel (SS), White (WH) See pgs 286–287 for custom labeling options. Call Customer Service for pricing.

Medi-Can™ Step Cans

- Economical solution for doctors' offices and clinics
- Fire-safe steel
- Complies with OSHA standards and OBRA regulations; see pages 2–3
- Self-closing lid fits tightly over molded plastic gasket for maximum odor control and quiet operation
- Plastic base ring protects floors



FGMST7E

FGMST15SS

FGMST35E



Steel hinge serves as sturdy carrying handle.

OSHA



OBRA



No.	Liner	Color	Description	U.S. Dimensions	U.S. Ship Wt/Ctn	Metric Dimensions	Metric Ship Wt/Ctn	Capacity (Gal)	Capacity (Liters)
FGMST15E	PL	WH	Medi-Can™ Step Can	8" dia x 11.5" h	4.0 lb	20.3 cm dia x 29.2 cm	1.8 kg	1.5	5.7
FGMST15	PL	SS	Medi-Can™ Step Can	8" dia x 11.5" h	4.0 lb	20.3 cm dia x 29.2 cm	1.8 kg	1.5	5.7
FGMST35E	PL	RD, WH	Medi-Can™ Step Can	10" dia x 15.75" h	6.0 lb	25.4 cm dia x 40 cm	2.7 kg	3.5	13.2
FGMST35	PL	SS	Medi-Can™ Step Can	10" dia x 15.75" h	6.0 lb	25.4 cm dia x 40 cm	2.7 kg	3.5	13.2
FGMST7E	GL	WH	Medi-Can™ Step Can	11.75" dia x 25" h	10.0 lb	29.8 cm dia x 63.5 cm	4.5 kg	8	30.3
FGMST7	GL	SS	Medi-Can™ Step Can	11.75" dia x 25" h	10.0 lb	29.8 cm dia x 63.5 cm	4.5 kg	8	30.3

Galvanized Liner (GL), Plastic Liner (PL) Red (RD), Stainless Steel (SS), White (WH) See pgs 286–287 for custom labeling options. Call Customer Service for pricing.

WHEN ORDERING PRODUCTS WITH BOLD COLOR CODES, PLEASE SPECIFY COLOR CODE AFTER THE PRODUCT NUMBER. REFER TO THE PRODUCT COLOR GUIDE AT THE BACK OF THE CATALOG.



Metal-based products with this symbol meet or exceed EPA guidelines for Post-Consumer Recycled Content.

Steel Wastebaskets

- Conform to Federal Specification A-A-182 for Fire Hazard and Flammability prevention
- Fire-safe, puncture-resistant steel
- FGWB26 and FGWB30R are UL-Classified fire-safe
- Raised bottom on all models prevents heat transfer to floors
- Round models feature a rolled wire rim, locked seamed design, and embossed panels for maximum strength and rigidity
- Rectangular models feature a vinyl top bumper to protect walls and steel legs with nylon buttons to protect floors



Steel Wastebasket Dome Tops

- Convert wastebaskets into economical fire-safe, self-extinguishing waste receptacles
- FGBBT1529 Dome Top is UL-Listed/FM-Approved fire-safe self-extinguishing and California State Fire Marshal Listed when used with our FGWB44 and FGWB2029 wastebaskets
- FGBBT1529 features a stainless steel, self-closing door to control odors; complies with OSHA Standards



STEEL WASTEBASKETS

No.	Color	Description	U.S. Dimensions	U.S. Ship Wt/Ctn	Metric Dimensions	Metric Ship Wt/Ctn	Capacity (Quart)	Capacity (Liters)	Pack
FGWB26 [†]	AL, BK, GR	Steel Open-Top Wastebasket	13.5" dia x 14.5" h	24.0 lb	34.3 cm dia x 36.8 cm	10.9 kg	26	98.4	6
FGWB30R [*]	AL, BK, GR	Steel Open-Top Wastebasket	17" w x 15" h	17.0 lb	43.2 cm x 38.1 cm	7.7 kg	30	113.6	3
FGWB44 ^{**}	AL, BK, GR	Steel Open-Top Wastebasket	15.75" dia x 18" h	14.0 lb	40 cm dia x 45.7 cm	6.4 kg	44	166.5	3
FGWB2029 ^{**}	AL, BK, GR	Steel Open-Top Wastebasket	16" dia x 29" h	28.0 lb	40.6 cm dia x 73.7 cm	12.7 kg	80	302.8	3
FGWB96R	AL, BK, GR	Steel Open-Top Wastebasket	21" w x 30" h	37.0 lb	53.3 cm x 76.2 cm	16.8 kg	96	363.4	3

Almond (AL), Black (BK), Gray (GR) [†]UL-Classified ^{*}FM-approved [#]UL-Listed when used with FGBBT1529

STEEL WASTEBASKET DOME TOPS

No.	Color	Description	U.S. Dimensions	U.S. Ship Wt/Ctn	Metric Dimensions	Metric Ship Wt/Ctn	Capacity (Quart)	Capacity (Liters)
FGBBT1529 [*]	AL, BK, GR	Steel Wastebasket Dome Top for FGWB44 or FGWB2029	16" dia	6.0 lb	40.6 cm dia	2.7 kg	N/A	N/A

Almond (AL), Black (BK), Gray (GR) [†]UL-Listed ^{*}FM-approved



WasteMaster Swing Tops

- Models FGT1414 and FGT1424 with rigid plastic liners are UL-Listed/fire-safe and self-extinguishing
- Comply with OSHA Standards
- Durable powder-coated or stainless steel
- Hinged top with self-closing, springless dual-entry disposal door
- Optional anchor kits available; contact your Rubbermaid Commercial Products Sales Representative
- Legs feature nylon base pads to protect floor



No.	Liner	Color	Description	Capacity (Gal)	Capacity (Liters)	U.S. Dimensions	U.S. Ship Wt/Ctn	Metric Dimensions	Metric Ship Wt/Ctn
FGT1414	RB PL ¹	SS	WasteMaster Hinged Top	14 10.5	53 39.7	14" sq x 26" h	21.0 lb	35.6 cm sq x 66 cm	9.5 kg
FGT1414E	RB PL ¹	WH	WasteMaster Hinged Top	14 10.5	53 39.7	14" sq x 26" h	23.0 lb	35.6 cm sq x 66 cm	10.4 kg
FGT1424	RB PL ¹	SS	WasteMaster Hinged Top	24 16	90.8 60.6	14" sq x 35.5" h	25.0 lb	35.6 cm sq x 90.2 cm	11.3 kg
FGT1424E	RB PL ¹	WH	WasteMaster Hinged Top	24 16	90.8 60.6	14" sq x 35.5" h	27.0 lb	35.6 cm sq x 90.2 cm	12.2 kg
FGT1940	RB PL	SS	WasteMaster Hinged Top	40 29	151.4 109.8	19" sq x 38" h	36.0 lb	48.3 cm sq x 96.5 cm	16.3 kg
FGT1940E	RB PL	WH	WasteMaster Hinged Top	40 29	151.4 109.8	19" sq x 38" h	42.0 lb	48.3 cm sq x 96.5 cm	19.1 kg

Retainer Bands Only (RB), Plastic Liner (PL) Stainless Steel (SS), White (WH) ¹ UL Listed
See pgs 286–287 for custom labeling options. Call Customer Service for pricing.

WasteMaster Open Tops

Drop-in design ideal for restrooms, clean rooms, operating rooms, and professional kitchens.

- Nonmagnetic stainless steel
- Open top design eliminates draft contamination
- Folding retainer bands hold can liners securely inside the receptacle
- Legs feature nylon base pads to protect floor



Built-in retainer bands securely hold can liner inside the container, eliminating unsightly overhang.



No.	Liner	Color	Description	Capacity (Gal)	Capacity (Liters)	U.S. Dimensions	U.S. Ship Wt/Ctn	Metric Dimensions	Metric Ship Wt/Ctn
FGB1414	RB PL	SS	WasteMaster Open Top – Clean Room	14 10.5	53 39.7	14" sq x 21" h	16.0 lb	35.6 cm sq x 53.3 cm	7.3 kg
FGB1424	RB PL	SS	WasteMaster Open Top – Clean Room	24 16	90.8 60.6	14" sq x 30" h	22.0 lb	35.6 cm sq x 76.2 cm	10 kg
FGB1940	RB PL	SS	WasteMaster Open Top – Clean Room	40 29	151.4 109.8	19" sq x 30" h	32.0 lb	48.3 cm sq x 76.2 cm	14.5 kg

Retainer Bands Only (RB), Plastic Liner (PL) Stainless (SS) See pgs 286–287 for custom labeling options.
Call Customer Service for pricing.

WHEN ORDERING PRODUCTS WITH **BOLD** COLOR CODES, PLEASE SPECIFY COLOR CODE AFTER THE PRODUCT NUMBER. REFER TO THE PRODUCT COLOR GUIDE AT THE BACK OF THE CATALOG.



Metal-based products with this symbol meet or exceed EPA guidelines for Post-Consumer Recycled Content.

Hands-Free Pedal Rolltop Container

Slim oval shape fits easily in tight spaces.

- Rolltop lid opens without drawing odors into the air
- Wraparound foot pedal is accessible from front and sides
- Slim shape fits under counters and out of the way



FG617700

No.	Color	Description	U.S. Dimensions	U.S. Capacity	U.S. Ship Wt/Ctn	Metric Dimensions	Metric Capacity	Metric Ship Wt/Ctn	Can Liners	Pack
FG617700	BEIG	Pedal Rolltop Container	22.25" l x 14.7" w x 27.2" h	14.5 gal	12.0 lb	56.5 cm x 37.3 cm x 69.1 cm	55 L	5.4 kg	5004-88 ^a	1

^aNot for sale in California.

Confidential Refuse Containers

Comprehensive secure document solution to help meet HIPAA requirements.

- Standard keyed lock provides increased security
- All containers ship fully assembled for immediate use
- Slim Jim® Confidential Document Containers are ideal for placement under desks, nursing stations, and counters; side entry slot provides easy access
- The large-capacity BRUTE® Confidential Document Rollout Containers allow bulk collection and mobility, and are compatible with semi-automatic and automatic lift systems
- The Metal Confidential Document Container with side-entry slot and flat top is ideal for extra storage
- BRUTE® Confidential Document Rollout Containers contain a UV stabilizer



FG9W1500



FG9W2500



FG9W1700



FG9W1088



FG9W1700 with copier on top

SLIM JIM® CONFIDENTIAL DOCUMENT CONTAINERS

No.	Color	Description	U.S. Dimensions	U.S. Capacity	U.S. Ship Wt/Ctn	Metric Dimensions	Metric Capacity	Metric Ship Wt/Ctn	Pack
FG9W1500	LGRAY	Slim Jim® Confidential Document Container with Lid	20" l x 11" w x 31" h	23 gal	37.0 lb	50.8 cm x 27.9 cm x 78.7 cm	87.1 L	18.7 kg	4
FG9W1600	LGRAY	Slim Jim® Confidential Document Container Lids for FG354000, FG354100 Containers	20.5" l x 11.63" w x 2.25" h	-	6.0 lb	52.1 cm x 29.5 cm x 5.7 cm	-	2.7 kg	4
FG9W2500	LGRAY	Slim Jim® Confidential Document Container with Handles and Lid	23.13" l x 11" w x 24.88" h	15% gal	29.3 lb	58.8 cm x 27.9 cm x 63.2 cm	60 L	13.3 kg	4
FG355300	SSSTL	Slim Jim® Stainless Steel Dolly for Slim Jim® Containers	20.38" l x 9.38" w x 9.5" h	120 lbs	14.5 lb	51.8 cm x 23.8 cm x 24.1 cm	N/A	6.6 kg	2
FG355188	BLA	Slim Jim® Trolley for FG354000, FG354100 Containers	23.4" l x 15" w x 10.8" h	-	20.8 lb	59.4 cm x 38.1 cm x 27.4 cm	-	9.4 kg	2

METAL CONFIDENTIAL DOCUMENT CONTAINER

No.	Color	Description	U.S. Dimensions	U.S. Capacity	U.S. Ship Wt/Ctn	Metric Dimensions	Metric Capacity	Metric Ship Wt/Ctn	Pack
FG9W1700	LPLAT	Metal Confidential Document Container with Confidential Document Bag	18.75" l x 20.75" w x 31" h	36 gal	43.0 lb	47.6 cm x 52.7 cm x 78.7 cm	136.3 L	19.5 kg	1

BRUTE® CONFIDENTIAL DOCUMENT ROLLOUT CONTAINERS

No.	Color	Description	U.S. Dimensions	U.S. Capacity	U.S. Ship Wt/Ctn	Metric Dimensions	Metric Capacity	Metric Ship Wt/Ctn	Pack
FG9W1088	GRAY	BRUTE® Confidential Document Rollout Container	32.3" l x 25.3" w x 41.8" h	65 gal	30.6 lb	82 cm x 64.3 cm x 106.2 cm	246.05 L	13.9 kg	1
FG9W1188	GRAY	BRUTE® Confidential Document Rollout Container	35.4" l x 27.3" w x 45.6" h	95 gal	41.0 lb	89.9 cm x 69.3 cm x 115.8 cm	359.6 L	18.6 kg	1

Outdoor Station Containers

Large-capacity recycling containers suitable for any outdoor environment.

- Customize your recycling streams by color
- Easy to recognize "recycling" blue and dark green
- All containers (except FG396800 and FG396900) come standard with the universal recycling symbol
- Increased capacity for high-traffic areas
- Glutton® Container (FG256B06 and FG256B73) accepts two FG35400 Slim Jim® Containers
- Permanent hot-stamped universal recycling logo



FG256B73 / FG256L00

FG396800

FG396973

No.	Color	Description	U.S. Dimensions	U.S. Ship Wt/Ctn	Metric Dimensions	U.S. Ship Wt/Ctn	Capacity (Gal)	Capacity (Liters)	Pack
FG256B06	DGRN	Glutton® Container	25.5" l x 22.75" w x 31.13" h	67.3 lb	64.8 cm x 57.8 cm x 79.1 cm	30.5 kg	50	189.3	4
FG256L00	DBLUE, DGRN	Glutton® Bottle and Can Recycling Top for FG256B00 Container	26.63" l x 23" w x 13" h	14.2 lb	67.6 cm x 58.4 cm x 33 cm	6.4 kg	N/A	N/A	1
FG256B73	BLUE	Glutton® Recycling Container	25.5" l x 22.75" w x 31.13" h	67.3 lb	64.8 cm x 57.8 cm x 79.1 cm	30.5 kg	56	212	4
FG396800	DGRN	Plaza® Bottle and Can Recycling Container	24.75" l x 25.25" w x 42.13" h	78.0 lb	62.9 cm x 64.1 cm x 107 cm	35.4 kg	N/A	N/A	1
FG396873*	BLUE	Plaza® Bottle and Can Recycling Container	24.75" l x 25.25" w x 42.13" h	78.0 lb	62.9 cm x 64.1 cm x 107 cm	35.4 kg	50	189.3	1
FG396900	DGRN	Plaza® Paper Recycling Container	24.75" l x 25.25" w x 42.13" h	78.0 lb	62.9 cm x 64.1 cm x 107 cm	35.4 kg	56	212	1
FG396973*	BLUE	Plaza® Paper Recycling Container	24.75" l x 25.25" w x 42.13" h	78.0 lb	62.9 cm x 64.1 cm x 107 cm	35.4 kg	50	189.3	1

*Custom imprinting available; contact Rubbermaid Customer Service at (800) 347-9800.

Recycling Boxes

Collection boxes for use in central locations.

- Recycling boxes are perfect for curbside recycling programs or multistream recycling
- Built-in handles for easier lifting and carrying
- Designed to stack or nest for increased productivity
- For use in high-volume paper generation, such as near copiers and printers and in mail rooms
- Commercial grade construction to withstand years of use indoors and out



FG571473

FG571873

FG571473

No.	Color	Description	U.S. Dimensions	U.S. Capacity	U.S. Ship Wt/Ctn	Metric Dimensions	Metric Capacity	Metric Ship Wt/Ctn	Pack
FG571473	BLUE, GRN	14-Gallon Recycling Box	20.75" l x 16" w x 14.75" h	14 gal	25.23 lb	52.7 cm x 40.6 cm x 37.5 cm	53 L	11.4 kg	6
FG571873	BLUE, GRN	18-Gallon Recycling Box	25.75" l x 16.5" w x 26.5" h	18 gal	30.36 lb	65.4 cm x 41.9 cm x 67.3 cm	68.1 L	13.8 kg	6

WHEN ORDERING PRODUCTS WITH BOLD COLOR CODES, PLEASE SPECIFY COLOR CODE AFTER THE PRODUCT NUMBER. REFER TO THE PRODUCT COLOR GUIDE AT THE BACK OF THE CATALOG.

Glutton® Recycling Stations

Support your facility's recycling program, help reduce labor costs, and improve worker well-being.

- High-capacity, all-in-one centralized solutions for efficient waste sortation
- Includes designated, item-specific tops, symbol label pack, and word label pack in English, French, and Spanish that provide visual cues and encourage compliance
- Hinged lid allows easy access during emptying



TWO-STREAM GLUTTON® RECYCLING STATION
1792340



FOUR-STREAM GLUTTON® RECYCLING STATION
1792372

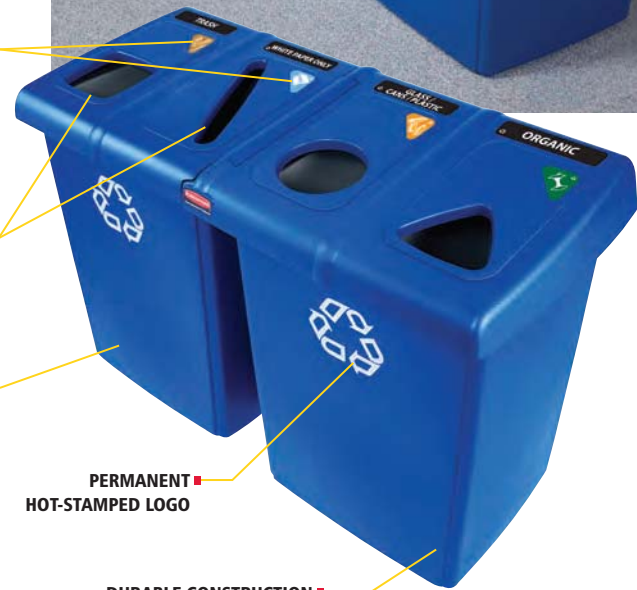

FLEXIBLE LABELING

Includes separate color-coded symbol and word labels for customizing the Recycling Station based on facility needs.

MULTIPLE STREAM SORTATION

Use any combination of the restrictive-opening tops to sort up to four separate waste streams. Tops snap securely into lid.

HIGH-CAPACITY COLLECTION

Improves productivity by reducing the frequency of trips to empty the filled containers. Holds up to 92 gallons of waste.

PERMANENT HOT-STAMPED LOGO

DURABLE CONSTRUCTION

Features traditional Rubbermaid Commercial Products' strength and durability in easy-to-clean, impact-resistant post-consumer plastic.



EASY TO EMPTY

Center hinge allows the lid to be opened from either side for easy access to waste. Eliminates the need to remove the lid during emptying and helps reduce worker strain and trip-and-fall hazards.

No.	Color	Description	U.S. Dimensions	Metric Dimensions	Capacity (Gal)	Capacity (Liters)	Pack
1792339	BLUE	Two-Stream Glutton® Recycling Station	26.8" l x 23.6" w x 35.5" h	68.1 cm x 59.9 cm x 90.2 cm	46	174.1	1
1792340	GREEN	Two-Stream Glutton® Recycling Station	26.8" l x 23.6" w x 35.5" h	68.1 cm x 59.9 cm x 90.2 cm	46	174.1	1
1792371	BEIGE	Two-Stream Glutton® Recycling Station	26.8" l x 23.6" w x 35.5" h	68.1 cm x 59.9 cm x 90.2 cm	46	174.1	1
1792372	BLUE	Four-Stream Glutton® Recycling Station	53" l x 24" w x 35.5" h	134.6 cm x 61 cm x 90.2 cm	92	348.3	1
1792373	GREEN	Four-Stream Glutton® Recycling Station	53" l x 24" w x 35.5" h	134.6 cm x 61 cm x 90.2 cm	92	348.3	1
1792374	BEIGE	Four-Stream Glutton® Recycling Station	53" l x 24" w x 35.5" h	134.6 cm x 61 cm x 90.2 cm	92	348.3	1
1792975		Recycle Label Kit	N/A	N/A	N/A	N/A	8

Steel Drum Tops

- Self-closing "PUSH" door
- Factory Mutual Approved Fire-Safe/Self-Extinguishing when used with a steel drum; complies with OSHA standards
- Includes thumbscrews for securing cover to drum

1855 Fits

- 55-Gal Steel Drum
- FGMT32 (see *Decorative Refuse: Americana Series™*)
- FGH55E and FGH55C (see *Decorative Refuse: Towne Series*)
- FGSBR52 (see *Decorative Refuse: Street Baskets*)

2030 Fits

- 30-Gal Steel Drum
- FGH12 (see *Decorative Refuse: Towne Series*)
- FGMT22 (see *Decorative Refuse: Americana Series™*)



OSHA



STEEL DRUM TOPS (SOLD SEPARATELY)

No.	Color	Description	U.S. Dimensions	U.S. Ship Wt/Ctn	Metric Dimensions	Metric Ship Wt/Ctn	Capacity (gal)	Capacity (Liters)
FG1855	BK, EGN, RD	Steel Drum Dome Top for use w/ FGH55, FGH55C, FGH55E, FGMT32, FGSBR52	24.5" dia	12.0 lb	62.2 cm dia	5.4 kg	N/A	N/A
FG2030	BK, BR, EGN	Steel Drum Dome Top for use w/ FGH12, FGMT22	20" dia	9.0 lb	50.8 cm dia	4.1 kg	N/A	N/A

Black (BK), Brown (BR), Empire Green (EGN), Red (RD) Custom colors available; see pgs 288–290. Call Customer Service for pricing.

Rigid Liners

Prolong the life of your containers.

- Designed to fit Rubbermaid Commercial Products' and other manufacturers' containers
- Durable plastic construction maximizes service life
- Easy-to-clean
- Prevents leaks and messes from occurring on the floor



FOR ADDITIONAL RIGID LINER OPTIONS, SEE THE *DECORATIVE REFUSE* SECTION, OR CALL YOUR RUBBERMAID SALES REPRESENTATIVE.

WHEN ORDERING PRODUCTS WITH **BOLD** COLOR CODES, PLEASE SPECIFY COLOR CODE AFTER THE PRODUCT NUMBER. REFER TO THE PRODUCT COLOR GUIDE AT THE BACK OF THE CATALOG.



Resin-based products with this symbol meet or exceed EPA guidelines for Post-Consumer Recycled Content.

Can Liners

High-quality can liners for a variety of applications.

- Strong "star seal" bottom eliminates gaps along the seal where leaks can occur
- Easily conforms to the shape of the container
- Distributes refuse weight evenly inside the liner

HIGH-DENSITY CORELESS ROLL

Great for paper and nonsharp objects under moderate transport conditions.

- Excellent resistance to puncture and light resistance to tearing
- Greater load capacity than linear low-density can liners
- Continuous coreless roll makes dispensing easy and reduces theft

LINEAR LOW-DENSITY

Recommended for sharper objects under tougher transport conditions.

- Excellent resistance to puncture and tearing
- Good load capacity
- Topside dual-dispensing carton allows for top or side dispensing



STAR SEAL BOTTOM

Strong star seal bottom is designed without gussets, where leaks are prone to occur.

STOP THROWING AWAY MONEY

Buy the right-sized can liner for your Rubbermaid Commercial Products® containers!



APPLICATIONS

HIGH-DENSITY

- Restaurants
- Office paper
- Construction
- Parks/stadiums

LINEAR LOW-DENSITY

- Janitorial
- Housekeeping
- Everyday use
- Schools

HIGH-DENSITY CORELESS ROLL CAN LINERS

No.	Color	Description	U.S. Dimensions	U.S. Size	U.S. Capacity	U.S. Ship Wt/Ctn	Metric Dimensions	Metric Size	Metric Capacity	Metric Ship Wt/Ctn	U.S./Metric Gauge	Pack
FG507600	CLR	High-Density Coreless Roll Can Liners	60" l x 36" w	72" cir	55 gal	20.2 lb	152.4 cm x 91.4 cm	182.8 cm	208.2 L	9.2 kg	.67 mil/17 µm	1/200 pcs
FG507900	CLR	High-Density Coreless Roll Can Liners	49" l x 43" w	86" cir	45-56 gal	18.6 lb	124.5 cm x 109.2 cm	218.4 cm	170-211 L	8.4 kg	.63 mil/16 µm	1/200 pcs

Materials comply with USDA and FDA regulations for food contact.

LINEAR LOW-DENSITY CAN LINERS

No.	Color	Fits (all product numbers begin with "FG"):	U.S. Dimensions	U.S. Size	U.S. Capacity	U.S. Ship Wt/Ctn	Metric Dimensions	Metric Size	Metric Capacity	Metric Ship Wt/Ctn	U.S./Metric Gauge	Pack
FG500288*	CLR	295200, 295500, 295600, 614200	24" l x 21.5" w	43" cir	6 gal	29.6 lb	61 cm x 54.6 cm	109.2 cm	22.7 L	13.4 kg	0.8 mil/20 µm	1/1000 pcs
FG500388*	CLR	261000, 294700, 295700, 307120	30" l x 23.75" w	47 1/2" cir	11 gal	20.3 lb	76.2 cm x 60.3 cm	120.6 cm	41.6 L	9.2 kg	0.8 mil/20 µm	1/500 pcs
FG500488*	GRAY	354600, 816088, 818488, 818588, 614300, 614400, 617700	38.75" l x 24.5" w	49" cir	22 gal	20.2 lb	98.4 cm x 62.2 cm	124.4 cm	83.3 L	9.2 kg	1.0 mil/25 µm	1/300 pcs
FG500588*	GRAY	352000, 356800, 356900, 782200, 782300, 817088, 818088, 818288, 818588	39" l x 27.5" w	55" cir	23 gal	22.7 lb	99.1 cm x 69.9 cm	139.7 cm	87.1 L	10.3 kg	1.0 mil/25 µm	1/300 pcs
FG500688*	GRAY	262000, 614687	34" l x 30" w	60" cir	20 gal	26.3 lb	86.4 cm x 76.2 cm	152.4 cm	75.7 L	11.9 kg	1.2 mil/30 µm	1/300 pcs
FG500788*	GRAY	263200, 263400, 263246, 263256	39" l x 34" w	68" cir	32 gal	33.7 lb	99.1 cm x 86.4 cm	172.7 cm	121.1 L	15.3 kg	1.2 mil/30 µm	1/300 pcs
FG500888*	GRAY, CLR	264100, 264300, 395800, 395900, 905800, 9P9000, 264346, 264356, 9P9100, 965100, 965200	44" l x 37" w	74" cir	44-50 gal	27.3 lb	111.8 cm x 94 cm	187.9 cm	166.5-189.2 L	12.4 kg	1.2 mil/30 µm	1/200 pcs
FG500988*	GRAY	354000, 354100, 396600, 396700, 614500, 614600, 818288, 355400, 3542-20	40" l x 29.25" w	58 1/2" cir	20-32 gal	29.9 lb	101.6 cm x 74.3 cm	148.5 cm	75.7-121.1 L	13.6 kg	1.2 mil/30 µm	1/300 pcs
FG501088*	GRAY	50-Gal (208.2-L) Drum	60" l x 36" w	72" cir	55 gal	18.4 lb	152.4 cm x 91.4 cm	182.8 cm	208.2 L	8.3 kg	1.2 mil/30 µm	1/100 pcs
FG501188*	GRAY	265500	48" l x 39.5" w	79" cir	55 gal	27.0 lb	121.9 cm x 100.3 cm	200.6 cm	208.2 L	12.2 kg	2.0 mil/50 µm	1/100 pcs
FG501388*	GRAY, CLR	256800, 256806, 9W2700, 9W2706	47" l x 43" w	86" cir	56 gal	28.7 lb	119.4 cm x 109.2 cm	218.4 cm	212 L	13 kg	2.0 mil/50 µm	1/100 pcs
FG501688*	GRAY	351700, 352600, 396300, 396400, 396500, 396800, 396900, 397000, 397100, 397200, 397500, 843000, 917100, 917200, 917300	42.5" l x 39" w	78" cir	45 gal	28.3 lb	108 cm x 99.1 cm	198.1 cm	170.3 L	12.8 kg	1.2 mil/30 µm	1/200 pcs
FG502888*	GRAY	50-Gal (189.3-L) Container 9W2700, 9W2706	47" l x 45" w	90" cir	50 gal	30.0 lb	119.4 cm x 114.3 cm	228.6 cm	189.3 L	13.6 kg	2.0 mil/50 µm	1/100 pcs

*Not for sale in California.



Smarter Decorative Refuse

Exceptional durability and customization options combine to provide upscale, cost-effective waste solutions for your facility. Rubbermaid® Decorative Refuse containers are built for looks and long-lasting performance, indoors and out.



COMMITTED TO SUSTAINABILITY

Rubbermaid Commercial Products is committed to manufacturing and delivering our products in an ecologically responsible manner. All of our plastic and metal containers are 100% recyclable.

Visit www.rubbermaidcommercial.com to learn more about sustainability initiatives from Rubbermaid Commercial Products.



This symbol, positioned with Decorative Receptacle refuse containers, indicates post-consumer recycled content (30% for steel, 70% for aluminum).



INDOOR CONTAINERS

Element Decorative Indoor Waste..... 154
 Silhouettes Half Rounds..... 156
 Silhouettes..... 156
 Silhouette Recycling 158
 Eclipse 159
 Atrium® Classic Containers 159
 Accents..... 160
 Atrium® Aluminum and Brass Containers.. 161
 Crowne Collection 162
 European Series..... 163
 Metallic Series 164
 Hide-A-Bag 165
 Concept Collection™ 165
 Marshal® Classic Containers..... 165
 Round-Tops..... 166
 StepMaster™ 166
 Steel Receptacles..... 167
 Milan Collection..... 168
 Tuscany Collection™ 169
 Galleria..... 170
 Open-Tops 170
 Cornerstone Series™ 171
 Foodcourt 172
 Covered-Tops..... 173
 Ash/Trash..... 174
 Half Rounds..... 174

One-Piece Lift-Off 175
 Fiberglass Recycling Containers 176
 Fiberglass Recycling Centers 176
 Collect-a-Cubes™ 177

OUTDOOR CONTAINERS

WeatherGard® Series 178
 Avenue..... 178
 Americana Series™ 179
 Architek® 180
 Architek® Custom Options..... 181
 Infinity™ Decorative Receptacle
 Containers 182
 Square Containers 183
 Round Containers..... 183
 Classics..... 184
 Classics Recycling Options 184
 Classics Custom Options 185
 Dimension 500 Series..... 186
 Dimension Standard Series 186
 Aspen Series..... 187
 Landmark Series® Classic Containers..... 188
 Towne Series 189
 Regent 50 Series..... 190
 Keystone Series™ 191
 Ranger® 192
 Plaza® 193
 Glutton® 193

Landmark Series® Security Container 194
 Street Baskets 194
 Landmark Series® Classic Containers..... 195
 Street Media Series..... 195
 Landmark Series® Gas Station/Store Front
 Containers 196

SMOKING MANAGEMENT

Metropolitan Smokers' Station..... 197
 Smokers' Pole 198
 Infinity™ Smoking Management
 Solutions 199
 Aladdin Smokers' Station® 200
 GroundsKeeper® Receptacles 200
 Smokers' Station® Wall Mount..... 201
 Classic Smoking Urns and Accessories 201
 Ash/Trash Containers 202

PLANTERS

Decorative Planters..... 203

LINERS

Liners for Decorative Refuse Containers 204

Decorative Refuse

Element Decorative Indoor Waste

Recycling solutions that fit your style!

- All units constructed with recycled steel and plastic exceed EPA guidelines for post-consumer recycled content
- Fire-safe, heavy-gauge, hot-dipped powder-coated steel for years of durable use
- Uni-Koat® powder-coated finish reduces fingerprints and provides an automotive grade finish
- Smooth surface allows easier cleaning



Multiple bag retention options provide added flexibility. Units are available with leak-proof, rigid polyethylene, or galvanized steel liners, or slide-out retainer bands.



VARYING NUMBER OF WASTE STREAMS AND CAPACITIES MEET ANY SORTATION NEED

1-Stream	21 gallons	Trash
2 Stream	24 gallons	Paper/Trash, Paper/Cans and Bottles, Trash/Cans and Bottles
3 Stream	44 gallons	Paper/Trash/Cans and Bottles
4 Stream	57 gallons	Paper/Bottles/Trash/Cans

ITEM-SPECIFIC OPENINGS

Different waste stream opening shapes help minimize contamination by providing visual cues for proper disposal and encourage recycling.



STANDARD COLORS

Silver Metallic	Desert Pearl
-----------------	--------------

Printed color may vary due to printer setup and resolution. For actual colors, please request a sample chip from RCP Customer Service. Custom colors available upon request.

WHEN ORDERING PRODUCTS WITH BOLD COLOR CODES, PLEASE SPECIFY COLOR CODE AFTER THE PRODUCT NUMBER. SEE THE PRODUCT COLOR GUIDE AT THE BACK OF THE CATALOG.



Check out the items marked with this symbol for our new line of Executive Series™ products.



3485982



3486003



3486008



3486048

1-STREAM ELEMENT RECYCLING CONTAINERS

No.	Color	Liner	Description	Capacity (gal)	Capacity (Liters)	U.S. Dimensions	U.S. Ship Wt/Ctn	Metric Dimensions	Metric Ship Wt/Ctn	Pack
3485982	SM	PL	1-Stream Waste/Recycling Station Nonlocking	21	79.5	14" l x 17.4" w x 36.9" h	46.0 lb	35.6 cm x 44.2 cm x 93.7 cm	20.9 kg	1
3485983	SM	PL	1-Stream Waste/Recycling Station Locking	21	79.5	14" l x 17.4" w x 36.9" h	46.0 lb	35.6 cm x 44.2 cm x 93.7 cm	20.9 kg	1
3485984	SM	GL	1-Stream Waste/Recycling Station Nonlocking	22	83.3	14" l x 17.4" w x 36.9" h	46.0 lb	35.6 cm x 44.2 cm x 93.7 cm	20.9 kg	1
3485985	DP	PL	1-Stream Waste/Recycling Station Nonlocking	21	79.5	14" l x 17.4" w x 36.9" h	46.0 lb	35.6 cm x 44.2 cm x 93.7 cm	20.9 kg	1
3485986	DP	PL	1-Stream Waste/Recycling Station Locking	21	79.5	14" l x 17.4" w x 36.9" h	46.0 lb	35.6 cm x 44.2 cm x 93.7 cm	20.9 kg	1
3485987	DP	GL	1-Stream Waste/Recycling Station Nonlocking	22	83.3	14" l x 17.4" w x 36.9" h	46.0 lb	35.6 cm x 44.2 cm x 93.7 cm	20.9 kg	1
3486037	SM	RB	1-Stream Waste/Recycling Station Nonlocking	22	83.3	14" l x 17.4" w x 36.9" h	46.0 lb	35.6 cm x 44.2 cm x 93.7 cm	20.9 kg	1
3486043	DP	RB	1-Stream Waste/Recycling Station Nonlocking	22	83.3	14" l x 17.4" w x 36.9" h	46.0 lb	35.6 cm x 44.2 cm x 93.7 cm	20.9 kg	1

2-STREAM ELEMENT RECYCLING CONTAINERS

No.	Color	Liner	Description	Capacity (gal)	Capacity (Liters)	U.S. Dimensions	U.S. Ship Wt/Ctn	Metric Dimensions	Metric Ship Wt/Ctn	Pack
3485988	SM	PL	2-Stream Paper/Trash Nonlocking	(2) 11.5	(2) 43.5	24.1" l x 16.4" w x 36.4" h	80.0 lb	61.2 cm x 41.7 cm x 92.5 cm	36.3 kg	1
3485989	SM	PL	2-Stream Paper/Trash Locking	(2) 11.5	(2) 43.5	24.1" l x 16.4" w x 36.4" h	80.0 lb	61.2 cm x 41.7 cm x 92.5 cm	36.3 kg	1
3485990	SM	GL	2-Stream Paper/Trash Nonlocking	(2) 12	(2) 45.4	24.1" l x 16.4" w x 36.4" h	86.0 lb	61.2 cm x 41.7 cm x 92.5 cm	39 kg	1
3485991	SM	PL	2-Stream Trash/Cans and Bottles Nonlocking	(2) 11.5	(2) 43.5	24.1" l x 16.4" w x 36.4" h	80.0 lb	61.2 cm x 41.7 cm x 92.5 cm	36.3 kg	1
3485992	SM	PL	2-Stream Trash/Cans and Bottles Locking	(2) 11.5	(2) 43.5	24.1" l x 16.4" w x 36.4" h	80.0 lb	61.2 cm x 41.7 cm x 92.5 cm	36.3 kg	1
3485993	SM	GL	2-Stream Trash/Cans and Bottles Nonlocking	(2) 12	(2) 45.4	24.1" l x 16.4" w x 36.4" h	86.0 lb	61.2 cm x 41.7 cm x 92.5 cm	39 kg	1
3485994	SM	PL	2-Stream Paper/Cans and Bottles Nonlocking	(2) 11.5	(2) 43.5	24.1" l x 16.4" w x 36.4" h	80.0 lb	61.2 cm x 41.7 cm x 92.5 cm	36.3 kg	1
3485995	SM	PL	2-Stream Paper/Cans and Bottles Locking	(2) 11.5	(2) 43.5	24.1" l x 16.4" w x 36.4" h	80.0 lb	61.2 cm x 41.7 cm x 92.5 cm	36.3 kg	1
3485996	SM	GL	2-Stream Paper/Cans and Bottles Nonlocking	(2) 12	(2) 45.4	24.1" l x 16.4" w x 36.4" h	86.0 lb	61.2 cm x 41.7 cm x 92.5 cm	39 kg	1
3485997	DP	PL	2-Stream Paper/Trash Nonlocking	(2) 11.5	(2) 43.5	24.1" l x 16.4" w x 36.4" h	80.0 lb	61.2 cm x 41.7 cm x 92.5 cm	36.3 kg	1
3485998	DP	PL	2-Stream Paper/Trash Locking	(2) 11.5	(2) 43.5	24.1" l x 16.4" w x 36.4" h	80.0 lb	61.2 cm x 41.7 cm x 92.5 cm	36.3 kg	1
3485999	DP	GL	2-Stream Paper/Trash Nonlocking	(2) 12	(2) 45.4	24.1" l x 16.4" w x 36.4" h	86.0 lb	61.2 cm x 41.7 cm x 92.5 cm	39 kg	1
3486000	DP	PL	2-Stream Trash/Cans and Bottles Nonlocking	(2) 11.5	(2) 43.5	24.1" l x 16.4" w x 36.4" h	80.0 lb	61.2 cm x 41.7 cm x 92.5 cm	36.3 kg	1
3486001	DP	PL	2-Stream Trash/Cans and Bottles Locking	(2) 11.5	(2) 43.5	24.1" l x 16.4" w x 36.4" h	80.0 lb	61.2 cm x 41.7 cm x 92.5 cm	36.3 kg	1
3486002	DP	GL	2-Stream Trash/Cans and Bottles Nonlocking	(2) 12	(2) 45.4	24.1" l x 16.4" w x 36.4" h	86.0 lb	61.2 cm x 41.7 cm x 92.5 cm	39 kg	1
3486003	DP	PL	2-Stream Paper/Cans and Bottles Nonlocking	(2) 11.5	(2) 43.5	24.1" l x 16.4" w x 36.4" h	80.0 lb	61.2 cm x 41.7 cm x 92.5 cm	36.3 kg	1
3486004	DP	PL	2-Stream Paper/Cans and Bottles Locking	(2) 11.5	(2) 43.5	24.1" l x 16.4" w x 36.4" h	80.0 lb	61.2 cm x 41.7 cm x 92.5 cm	36.3 kg	1
3486005	DP	GL	2-Stream Paper/Cans and Bottles Nonlocking	(2) 12	(2) 45.4	24.1" l x 16.4" w x 36.4" h	86.0 lb	61.2 cm x 41.7 cm x 92.5 cm	39 kg	1
3486038	SM	RB	2-Stream Paper/Trash Nonlocking	(2) 12	(2) 45.4	24.1" l x 16.4" w x 36.4" h	78.0 lb	61.2 cm x 41.7 cm x 92.5 cm	35.4 kg	1
3486039	SM	RB	2-Stream Trash/Cans and Bottles Nonlocking	(2) 12	(2) 45.4	24.1" l x 16.4" w x 36.4" h	78.0 lb	61.2 cm x 41.7 cm x 92.5 cm	35.4 kg	1
3486040	SM	RB	2-Stream Paper/Cans and Bottles Nonlocking	(2) 12	(2) 45.4	24.1" l x 16.4" w x 36.4" h	78.0 lb	61.2 cm x 41.7 cm x 92.5 cm	35.4 kg	1
3486044	DP	RB	2-Stream Paper/Cans and Bottles Nonlocking	(2) 12	(2) 45.4	24.1" l x 16.4" w x 36.4" h	78.0 lb	61.2 cm x 41.7 cm x 92.5 cm	35.4 kg	1
3486045	DP	RB	2-Stream Paper/Trash Nonlocking	(2) 12	(2) 45.4	24.1" l x 16.4" w x 36.4" h	78.0 lb	61.2 cm x 41.7 cm x 92.5 cm	35.4 kg	1
3486046	DP	RB	2-Stream Paper/Cans and Bottles Nonlocking	(2) 12	(2) 45.4	24.1" l x 16.4" w x 36.4" h	78.0 lb	61.2 cm x 41.7 cm x 92.5 cm	35.4 kg	1

3-STREAM ELEMENT RECYCLING CONTAINERS

No.	Color	Liner	Description	Capacity (gal)	Capacity (Liters)	U.S. Dimensions	U.S. Ship Wt/Ctn	Metric Dimensions	Metric Ship Wt/Ctn	Pack
3486006	SM	PL	3-Stream Paper/Trash/Cans and Bottles, Nonlocking	(1) 21, (2) 11.5	(1) 79.5, (2) 43.5	38.4" l x 17.4" w x 36.9" h	126.0 lb	97.5 cm x 44.2 cm x 93.7 cm	57.2 kg	1
3486007	SM	PL	3-Stream Paper/Trash/Cans and Bottles, Locking	(1) 21, (2) 11.5	(1) 79.5, (2) 43.5	38.4" l x 17.4" w x 36.9" h	126.0 lb	97.5 cm x 44.2 cm x 93.7 cm	57.2 kg	1
3486008	SM	GL	3-Stream Paper/Trash/Cans and Bottles, Nonlocking	(1) 22, (2) 12	(1) 83.3, (2) 45.4	38.4" l x 17.4" w x 36.9" h	136.0 lb	97.5 cm x 44.2 cm x 93.7 cm	61.7 kg	1
3486009	DP	PL	3-Stream Paper/Trash/Cans and Bottles, Nonlocking	(1) 21, (2) 11.5	(1) 79.5, (2) 43.5	38.4" l x 17.4" w x 36.9" h	126.0 lb	97.5 cm x 44.2 cm x 93.7 cm	57.2 kg	1
3486010	DP	PL	3-Stream Paper/Trash/Cans and Bottles, Locking	(1) 21, (2) 11.5	(1) 79.5, (2) 43.5	38.4" l x 17.4" w x 36.9" h	126.0 lb	97.5 cm x 44.2 cm x 93.7 cm	57.2 kg	1
3486011	DP	GL	3-Stream Paper/Trash/Cans and Bottles, Nonlocking	(1) 22, (2) 12	(1) 83.3, (2) 45.4	38.4" l x 17.4" w x 36.9" h	136.0 lb	97.5 cm x 44.2 cm x 93.7 cm	61.7 kg	1
3486041	SM	RB	3-Stream Paper/Trash/Cans and Bottles, Nonlocking	(1) 22, (2) 12	(1) 83.3, (2) 45.4	38.4" l x 17.4" w x 36.9" h	124.0 lb	97.5 cm x 44.2 cm x 93.7 cm	56.2 kg	1
3486047	DP	RB	3-Stream Paper/Trash/Cans and Bottles, Nonlocking	(1) 22, (2) 12	(1) 83.3, (2) 45.4	38.4" l x 17.4" w x 36.9" h	124.0 lb	97.5 cm x 44.2 cm x 93.7 cm	56.2 kg	1

4-STREAM ELEMENT RECYCLING CONTAINERS

No.	Color	Liner	Description	Capacity (gal)	Capacity (Liters)	U.S. Dimensions	U.S. Ship Wt/Ctn	Metric Dimensions	Metric Ship Wt/Ctn	Pack
3486012	SM	PL	4-Stream Paper/Bottles/Trash/Cans, Nonlocking	(2) 11.5, (2) 17	(2) 43.5, (2) 64.4	48.5" l x 18.5" w x 37.1" h	150.0 lb	123.2 cm x 47 cm x 94.2 cm	68 kg	1
3486013	SM	PL	4-Stream Paper/Bottles/Trash/Cans, Locking	(2) 11.5, (2) 17	(2) 43.5, (2) 64.4	48.5" l x 18.5" w x 37.1" h	150.0 lb	123.2 cm x 47 cm x 94.2 cm	68 kg	1
3486014	SM	GL	4-Stream Paper/Bottles/Trash/Cans, Nonlocking	(2) 12, (2) 18	(2) 45.4, (2) 68.1	48.5" l x 18.5" w x 37.1" h	170.0 lb	123.2 cm x 47 cm x 94.2 cm	77.1 kg	1
3486015	DP	PL	4-Stream Paper/Bottles/Trash/Cans, Nonlocking	(2) 11.5, (2) 17	(2) 43.5, (2) 64.4	48.5" l x 18.5" w x 37.1" h	170.0 lb	123.2 cm x 47 cm x 94.2 cm	77.1 kg	1
3486016	DP	PL	4-Stream Paper/Bottles/Trash/Cans, Locking	(2) 11.5, (2) 17	(2) 43.5, (2) 64.4	48.5" l x 18.5" w x 37.1" h	170.0 lb	123.2 cm x 47 cm x 94.2 cm	77.1 kg	1
3486017	DP	GL	4-Stream Paper/Bottles/Trash/Cans, Nonlocking	(2) 12, (2) 18	(2) 45.4, (2) 68.1	48.5" l x 18.5" w x 37.1" h	184.0 lb	123.2 cm x 47 cm x 94.2 cm	83.5 kg	1
3486042	SM	RB	4-Stream Paper/Bottles/Trash/Cans, Nonlocking	(2) 12, (2) 18	(2) 45.4, (2) 68.1	48.5" l x 18.5" w x 37.1" h	168.0 lb	123.2 cm x 47 cm x 94.2 cm	76.2 kg	1
3486048	DP	RB	4-Stream Paper/Bottles/Trash/Cans, Locking	(2) 12, (2) 18	(2) 45.4, (2) 68.1	48.5" l x 18.5" w x 37.1" h	168.0 lb	123.2 cm x 47 cm x 94.2 cm	76.2 kg	1

Silver Metallic (SM), Desert Pearl (DP) Plastic Liner (PL), Galvanized Liner (GL), Retainer Bands (RB)

Custom label options available. Call Customer Service for pricing. For replacement liners, see *Decorative Refuse Liners*.

Product is Made to Order (MTO); extended lead times apply.



FGSH12ESM

FGSH12EDP

FGSH12ETBK

FGSH12SS

Leak-Proof Rigid Plastic Liner Included

Silhouettes Half Rounds

Designed to fit flush against a wall to reduce obstruction in high-traffic areas.

- Open-top design allows for handsfree trash disposal
- Available with leak-proof rigid liner
- Custom decal options (see pages 286–291)



No.	Liner	Color	Description	Capacity (Gal)	Capacity (Liters)	U.S. Dimensions	U.S. Ship Wt/Ctn	Metric Dimensions	Metric Ship Wt/Ctn	U.S. List Price (Ea.)
FGSH12E	PL	SS	Silhouettes Half Round Trash Open-Top	12	45.4	18" w x 32" h	26.0 lb	45.7 cm x 81.3 cm	11.8 kg	528.00

Textured Black (TBK), Desert Pearl (DP), Silver Metallic (SM), Stainless Steel (SS)
Plastic Liner (PL)

Custom options available on pgs 286–291. Call Customer Service for pricing. For replacement liners, see page 204.

Silhouettes

The sleek lines and graphic pattern of this collection meet the needs of modern interior design styles.

- Heavy-gauge, fire-safe powder-coated or stainless steel
- Folding retainer bands hold can liners securely out of sight
- Convenient Hinged-Top
- Available with leak-proof rigid plastic liners
- Leg levelers provide stability

CUSTOM DECAL OPTIONS AVAILABLE, SEE PAGES 286–291.



ADA COMPLIANT



FGSC22ESM

Leak-Proof Rigid Plastic Liner Included

FGSR18SS

FGSC18SS

FGSR14SS

FGSC18EDP

FGSCSUTBK

FGSC10ETBK

SILHOUETTE WASTE CONTAINERS

WHEN ORDERING PRODUCTS WITH **BOLD** COLOR CODES, PLEASE SPECIFY COLOR CODE AFTER THE PRODUCT NUMBER. SEE THE PRODUCT COLOR GUIDE AT THE BACK OF THE CATALOG.

This symbol, positioned with Decorative Receptacle refuse containers, indicates post-consumer recycled content (30% for steel, 70% for aluminum).



Silhouettes

No.	Liner	Color	Description	Capacity (Gal)	Capacity (Liters)	U.S. Dimensions	U.S. Ship Wt/Ctn	Metric Dimensions	Metric Ship Wt/Ctn																																																																																																																																																																																																																																												
FGSC10E	RB	TBK	Silhouettes Open-Top Square Receptacle	10	37.9	10.75" sq x 25" h	18.0 lb	27.3 cm sq x 63.5 cm	8.2 kg																																																																																																																																																																																																																																												
	PL	TBK		6	22.7					FGSC10	RB	SS	Silhouettes Open-Top Square Receptacle	10	37.9	10.75" sq x 25" h	15.0 lb	27.3 cm sq x 63.5 cm	6.8 kg	PL	SS	6	22.7	FGSC14E	RB	TBK	Silhouettes Open-Top Square Receptacle	24	90.8	14.75" sq x 30" h	29.0 lb	37.5 cm sq x 76.2 cm	13.2 kg	RB	DP, SM	24	90.8	PL	TBK	16	60.6	PL	DP, SM	16	60.6	FGSC14	RB	SS	Silhouettes Open-Top Square Receptacle	24	90.8	14.75" sq x 30" h	27.0 lb	37.5 cm sq x 76.2 cm	12.2 kg	PL	SS	16	60.6	FGSC18E	RB	TBK	Silhouettes Open-Top Square Receptacle	29	109.8	18.75" sq x 30" h	39.0 lb	47.6 cm sq x 76.2 cm	17.7 kg	RB	DP, SM	29	109.8	PL	TBK	20	75.7	FGSC18	PL	DP, SM	Silhouettes Open-Top Square Receptacle	20	75.7	18.75" sq x 30" h	37.0 lb	47.6 cm sq x 76.2 cm	16.8 kg	RB	SS	29	109.8	FGSC22E	RB	TBK	Silhouettes Open-Top Square Receptacle	50	189.3	21.75" sq x 31.25" h	51.0 lb	55.2 cm sq x 79.4 cm	23.1 kg	RB	DP, SM	50	189.3	PL	TBK	40	151.4	PL	DP, SM	40	151.4	FGSC22	RB	SS	Silhouettes Open-Top Square Receptacle	50	189.3	21.75" sq x 31.25" h	51.0 lb	55.2 cm sq x 79.4 cm	23.1 kg	PL	SS	40	151.4	FGSR18	RB	SS	Silhouettes Large Rectangular Waste Receptacle	40	151.4	24" w x 30" h	34.0 lb	61 cm x 76.2 cm	15.4 kg	PL	SS	22.5	85.2	FGSCSU	N/A	TBK	Silhouettes Square Sand Urn	N/A	N/A	10.75" sq x 25" h	18.0 lb	27.3 cm sq x 63.5 cm	8.2 kg	N/A	SS	N/A	N/A	FGSR14E	RB	TBK	Silhouettes Small Rectangular Waste Receptacle	25	94.6	19.5" w x 30" h	28.0 lb	49.5 cm x 76.2 cm	12.7 kg	RB	DP, SM	25	94.6	PL	TBK	13	49.2	PL	DP, SM	13	49.2	FGSR14	RB	SS	Silhouettes Small Rectangular Waste Receptacle	25	94.6	19.5" w x 30" h	27.0 lb	49.5 cm x 76.2 cm	12.2 kg	PL	SS	13	49.2	FGSR18E	RB	TBK	Silhouettes Large Rectangular Waste Receptacle	40	151.4	24" w x 30" h	35.0 lb	61 cm x 76.2 cm	15.9 kg	RB	DP, SM	40	151.4	PL	TBK	22.5	85.2	PL	DP, SM	22.5	85.2	FGSR18	RB	SS	Silhouettes Large Rectangular Waste Receptacle	40	151.4	24" w x 30" h	34.0 lb	61 cm x 76.2 cm	15.4 kg	PL	SS	22.5	85.2	FGSCSU	N/A	TBK	Silhouettes Square Sand Urn	N/A	N/A	10.75" sq x 25" h	18.0 lb	27.3 cm sq x 63.5 cm	8.2 kg	N/A	SS	N/A	N/A				
FGSC10	RB	SS	Silhouettes Open-Top Square Receptacle	10	37.9	10.75" sq x 25" h	15.0 lb	27.3 cm sq x 63.5 cm	6.8 kg																																																																																																																																																																																																																																												
	PL	SS		6	22.7					FGSC14E	RB	TBK	Silhouettes Open-Top Square Receptacle	24	90.8	14.75" sq x 30" h	29.0 lb	37.5 cm sq x 76.2 cm	13.2 kg	RB	DP, SM	24	90.8		PL	TBK		16	60.6					PL	DP, SM	16	60.6	FGSC14	RB	SS	Silhouettes Open-Top Square Receptacle	24	90.8	14.75" sq x 30" h	27.0 lb	37.5 cm sq x 76.2 cm	12.2 kg	PL	SS	16	60.6	FGSC18E	RB	TBK	Silhouettes Open-Top Square Receptacle	29	109.8	18.75" sq x 30" h	39.0 lb		47.6 cm sq x 76.2 cm	17.7 kg		RB	DP, SM					29	109.8	PL	TBK	20	75.7	FGSC18	PL	DP, SM	Silhouettes Open-Top Square Receptacle	20	75.7	18.75" sq x 30" h	37.0 lb	47.6 cm sq x 76.2 cm	16.8 kg	RB	SS	29	109.8	FGSC22E	RB		TBK	Silhouettes Open-Top Square Receptacle		50	189.3					21.75" sq x 31.25" h	51.0 lb	55.2 cm sq x 79.4 cm	23.1 kg	RB	DP, SM	50	189.3	PL	TBK	40	151.4	PL	DP, SM	40	151.4	FGSC22	RB	SS	Silhouettes Open-Top Square Receptacle	50	189.3	21.75" sq x 31.25" h	51.0 lb	55.2 cm sq x 79.4 cm	23.1 kg	PL	SS	40	151.4	FGSR18	RB	SS	Silhouettes Large Rectangular Waste Receptacle	40	151.4	24" w x 30" h	34.0 lb	61 cm x 76.2 cm	15.4 kg	PL	SS	22.5	85.2	FGSCSU	N/A	TBK	Silhouettes Square Sand Urn	N/A	N/A	10.75" sq x 25" h	18.0 lb	27.3 cm sq x 63.5 cm	8.2 kg		N/A	SS		N/A	N/A					FGSR14E	RB	TBK	Silhouettes Small Rectangular Waste Receptacle	25	94.6	19.5" w x 30" h	28.0 lb	49.5 cm x 76.2 cm	12.7 kg	RB	DP, SM	25	94.6	PL	TBK	13	49.2	PL	DP, SM	13	49.2	FGSR14	RB	SS	Silhouettes Small Rectangular Waste Receptacle		25	94.6		19.5" w x 30" h	27.0 lb					49.5 cm x 76.2 cm	12.2 kg	PL	SS	13	49.2	FGSR18E	RB	TBK	Silhouettes Large Rectangular Waste Receptacle	40	151.4	24" w x 30" h	35.0 lb	61 cm x 76.2 cm	15.9 kg	RB	DP, SM	40	151.4	PL	TBK	22.5	85.2	PL	DP, SM	22.5	85.2	FGSR18	RB	SS	Silhouettes Large Rectangular Waste Receptacle	40	151.4	24" w x 30" h	34.0 lb	61 cm x 76.2 cm	15.4 kg	PL	SS	22.5	85.2	FGSCSU	N/A
FGSC14E	RB	TBK	Silhouettes Open-Top Square Receptacle	24	90.8	14.75" sq x 30" h	29.0 lb	37.5 cm sq x 76.2 cm	13.2 kg																																																																																																																																																																																																																																												
	RB	DP, SM		24	90.8																																																																																																																																																																																																																																																
	PL	TBK		16	60.6																																																																																																																																																																																																																																																
	PL	DP, SM		16	60.6																																																																																																																																																																																																																																																
FGSC14	RB	SS	Silhouettes Open-Top Square Receptacle	24	90.8	14.75" sq x 30" h	27.0 lb	37.5 cm sq x 76.2 cm	12.2 kg																																																																																																																																																																																																																																												
	PL	SS		16	60.6																																																																																																																																																																																																																																																
FGSC18E	RB	TBK	Silhouettes Open-Top Square Receptacle	29	109.8	18.75" sq x 30" h	39.0 lb	47.6 cm sq x 76.2 cm	17.7 kg																																																																																																																																																																																																																																												
	RB	DP, SM		29	109.8																																																																																																																																																																																																																																																
	PL	TBK		20	75.7																																																																																																																																																																																																																																																
FGSC18	PL	DP, SM	Silhouettes Open-Top Square Receptacle	20	75.7	18.75" sq x 30" h	37.0 lb	47.6 cm sq x 76.2 cm	16.8 kg																																																																																																																																																																																																																																												
	RB	SS		29	109.8																																																																																																																																																																																																																																																
FGSC22E	RB	TBK	Silhouettes Open-Top Square Receptacle	50	189.3	21.75" sq x 31.25" h	51.0 lb	55.2 cm sq x 79.4 cm	23.1 kg																																																																																																																																																																																																																																												
	RB	DP, SM		50	189.3																																																																																																																																																																																																																																																
	PL	TBK		40	151.4																																																																																																																																																																																																																																																
	PL	DP, SM		40	151.4																																																																																																																																																																																																																																																
FGSC22	RB	SS	Silhouettes Open-Top Square Receptacle	50	189.3	21.75" sq x 31.25" h	51.0 lb	55.2 cm sq x 79.4 cm	23.1 kg																																																																																																																																																																																																																																												
	PL	SS		40	151.4																																																																																																																																																																																																																																																
FGSR18	RB	SS	Silhouettes Large Rectangular Waste Receptacle	40	151.4	24" w x 30" h	34.0 lb	61 cm x 76.2 cm	15.4 kg																																																																																																																																																																																																																																												
	PL	SS		22.5	85.2																																																																																																																																																																																																																																																
FGSCSU	N/A	TBK	Silhouettes Square Sand Urn	N/A	N/A	10.75" sq x 25" h	18.0 lb	27.3 cm sq x 63.5 cm	8.2 kg																																																																																																																																																																																																																																												
	N/A	SS		N/A	N/A																																																																																																																																																																																																																																																
FGSR14E	RB	TBK	Silhouettes Small Rectangular Waste Receptacle	25	94.6	19.5" w x 30" h	28.0 lb	49.5 cm x 76.2 cm	12.7 kg																																																																																																																																																																																																																																												
	RB	DP, SM		25	94.6																																																																																																																																																																																																																																																
	PL	TBK		13	49.2																																																																																																																																																																																																																																																
	PL	DP, SM		13	49.2																																																																																																																																																																																																																																																
FGSR14	RB	SS	Silhouettes Small Rectangular Waste Receptacle	25	94.6	19.5" w x 30" h	27.0 lb	49.5 cm x 76.2 cm	12.2 kg																																																																																																																																																																																																																																												
	PL	SS		13	49.2																																																																																																																																																																																																																																																
FGSR18E	RB	TBK	Silhouettes Large Rectangular Waste Receptacle	40	151.4	24" w x 30" h	35.0 lb	61 cm x 76.2 cm	15.9 kg																																																																																																																																																																																																																																												
	RB	DP, SM		40	151.4																																																																																																																																																																																																																																																
	PL	TBK		22.5	85.2																																																																																																																																																																																																																																																
	PL	DP, SM		22.5	85.2																																																																																																																																																																																																																																																
FGSR18	RB	SS	Silhouettes Large Rectangular Waste Receptacle	40	151.4	24" w x 30" h	34.0 lb	61 cm x 76.2 cm	15.4 kg																																																																																																																																																																																																																																												
	PL	SS		22.5	85.2																																																																																																																																																																																																																																																
FGSCSU	N/A	TBK	Silhouettes Square Sand Urn	N/A	N/A	10.75" sq x 25" h	18.0 lb	27.3 cm sq x 63.5 cm	8.2 kg																																																																																																																																																																																																																																												
	N/A	SS		N/A	N/A																																																																																																																																																																																																																																																

Textured Black (TBK), Desert Pearl (DP), Silver Metallic (SM), Stainless Steel (SS)

Retainer Bands Only (RB), Plastic Liner (PL)

Custom options available on pgs 286–291. Call Customer Service for pricing. For replacement liners, see page 204.

Silhouette Recycling

Shown with factory-applied die-cut decals.



- Constructed of heavy-gauge, fire-safe steel or stainless steel
- Includes a leak-proof rigid plastic liner and adjustable leg levelers
- Round models feature lift-off lids
- Square models include piano-hinge tops and folding retainer bands to keep can liners out of sight
- Choose from three item-specific openings with protective vinyl trim to support your unique recycling program



SILHOUETTE RECYCLING CONTAINERS

No.	Color	Liner	Description	Capacity (gal)	Capacity (Liters)	U.S. Dimensions	U.S. Ship Wt/Ctn	Metric Dimensions	Metric Ship Wt/Ctn																																																																
FGDCR24C	DP, SM, TBK	PL	Silhouette Recycling Square 29 Gal – Cans	29	109.8	18.5" w x 32.38" h	47.5 lb	47 cm x 82.2 cm	21.5 kg																																																																
	SS	PL		29	109.8					FGDCR24P	DP, SM, TBK	PL	Silhouette Recycling Square 29 Gal – Paper	29	109.8	18.5" w x 32.38" h	47.5 lb	47 cm x 82.2 cm	21.5 kg	SS	PL	29	109.8	FGDCR24T	DP, SM, TBK	PL	Silhouette Recycling Square 29 Gal – Trash	29	109.8	18.5" w x 32.38" h	47.5 lb	47 cm x 82.2 cm	21.5 kg	SS	PL	29	109.8	FGDRR24C	DP, SM, TBK	PL	Silhouette Recycling Round 26 Gal – Cans	26	98.4	20.156" dia x 31.25" h	40.3 lb	51.2 cm dia x 79.4 cm	18.3 kg	SS	PL	26	98.4	FGDRR24P	DP, SM, TBK	PL	Silhouette Recycling Round 26 Gal – Paper	26	98.4	20.156" dia x 31.25" h	40.3 lb	51.2 cm dia x 79.4 cm	18.3 kg	SS	PL	26	98.4	FGDRR24T	DP, SM, TBK	PL	Silhouette Recycling Round 26 Gal – Trash	26	98.4	20.156" dia x 31.25" h	40.3 lb
FGDCR24P	DP, SM, TBK	PL	Silhouette Recycling Square 29 Gal – Paper	29	109.8	18.5" w x 32.38" h	47.5 lb	47 cm x 82.2 cm	21.5 kg																																																																
	SS	PL		29	109.8					FGDCR24T	DP, SM, TBK	PL	Silhouette Recycling Square 29 Gal – Trash	29	109.8	18.5" w x 32.38" h	47.5 lb	47 cm x 82.2 cm	21.5 kg	SS	PL	29	109.8	FGDRR24C	DP, SM, TBK	PL	Silhouette Recycling Round 26 Gal – Cans	26	98.4	20.156" dia x 31.25" h	40.3 lb	51.2 cm dia x 79.4 cm	18.3 kg	SS	PL	26	98.4	FGDRR24P	DP, SM, TBK	PL	Silhouette Recycling Round 26 Gal – Paper	26	98.4	20.156" dia x 31.25" h	40.3 lb	51.2 cm dia x 79.4 cm	18.3 kg	SS	PL	26	98.4	FGDRR24T	DP, SM, TBK	PL	Silhouette Recycling Round 26 Gal – Trash	26	98.4	20.156" dia x 31.25" h	40.3 lb	51.2 cm dia x 79.4 cm	18.3 kg	SS	PL	26	98.4								
FGDCR24T	DP, SM, TBK	PL	Silhouette Recycling Square 29 Gal – Trash	29	109.8	18.5" w x 32.38" h	47.5 lb	47 cm x 82.2 cm	21.5 kg																																																																
	SS	PL		29	109.8					FGDRR24C	DP, SM, TBK	PL	Silhouette Recycling Round 26 Gal – Cans	26	98.4	20.156" dia x 31.25" h	40.3 lb	51.2 cm dia x 79.4 cm	18.3 kg	SS	PL	26	98.4	FGDRR24P	DP, SM, TBK	PL	Silhouette Recycling Round 26 Gal – Paper	26	98.4	20.156" dia x 31.25" h	40.3 lb	51.2 cm dia x 79.4 cm	18.3 kg	SS	PL	26	98.4	FGDRR24T	DP, SM, TBK	PL	Silhouette Recycling Round 26 Gal – Trash	26	98.4	20.156" dia x 31.25" h	40.3 lb	51.2 cm dia x 79.4 cm	18.3 kg	SS	PL	26	98.4																						
FGDRR24C	DP, SM, TBK	PL	Silhouette Recycling Round 26 Gal – Cans	26	98.4	20.156" dia x 31.25" h	40.3 lb	51.2 cm dia x 79.4 cm	18.3 kg																																																																
	SS	PL		26	98.4					FGDRR24P	DP, SM, TBK	PL	Silhouette Recycling Round 26 Gal – Paper	26	98.4	20.156" dia x 31.25" h	40.3 lb	51.2 cm dia x 79.4 cm	18.3 kg	SS	PL	26	98.4	FGDRR24T	DP, SM, TBK	PL	Silhouette Recycling Round 26 Gal – Trash	26	98.4	20.156" dia x 31.25" h	40.3 lb	51.2 cm dia x 79.4 cm	18.3 kg	SS	PL	26	98.4																																				
FGDRR24P	DP, SM, TBK	PL	Silhouette Recycling Round 26 Gal – Paper	26	98.4	20.156" dia x 31.25" h	40.3 lb	51.2 cm dia x 79.4 cm	18.3 kg																																																																
	SS	PL		26	98.4					FGDRR24T	DP, SM, TBK	PL	Silhouette Recycling Round 26 Gal – Trash	26	98.4	20.156" dia x 31.25" h	40.3 lb	51.2 cm dia x 79.4 cm	18.3 kg	SS	PL	26	98.4																																																		
FGDRR24T	DP, SM, TBK	PL	Silhouette Recycling Round 26 Gal – Trash	26	98.4	20.156" dia x 31.25" h	40.3 lb	51.2 cm dia x 79.4 cm	18.3 kg																																																																
	SS	PL		26	98.4																																																																				

Retainer Bands Only (RB), Plastic Liner (PL) Desert Pearl (DP), Silver Metallic (SM), Stainless Steel (SS), Textured Black (TBK)
 See pgs 286–291. for custom options. Call Customer Service for pricing. For replacement liners, see page 204.

WHEN ORDERING PRODUCTS WITH **BOLD** COLOR CODES, PLEASE SPECIFY COLOR CODE AFTER THE PRODUCT NUMBER. SEE THE PRODUCT COLOR GUIDE AT THE BACK OF THE CATALOG.



Check out the items marked with this symbol for our new line of Executive Series™ products.



FGR2030SS

FGR2030EBK
Shown with custom graphics

Eclipse

New Eclipse with its exclusive curved top is a stylish addition to any contemporary décor.

- Heavy-gauge, fire-safe powder-coated or nonmagnetic stainless steel
- Curved top prevents the placement of objects on the top edge of receptacle
- Custom logos and graphics available; contact your Rubbermaid Commercial Products' Sales Representative
- Hands-free, 30-gallon capacity
- Indoor use recommended
- Leak-proof rigid plastic liners included



ECLIPSE

No.	Color	Description	Capacity (Gal)	Capacity (Liters)	U.S. Dimensions	U.S. Ship Wt/Ctn	Metric Dimensions	Metric Ship Wt/Ctn	Liner
FGR2030	SS	Eclipse Open-Top	30	113.6	20" dia x 33.5" h	N/A	50.8 cm dia x 85.1 cm	N/A	PL
FGR2030E	BK	Eclipse Open-Top	30	113.6	20" dia x 33.5" h	47.0 lb	50.8 cm dia x 85.1 cm	21.3 kg	PL

Black (BK), Satin Stainless Steel (SS) Plastic Liner (PL)
Custom labeling options available; see pgs 286–291. Call Customer Service for pricing.

Atrium® Classic Containers

Attractive open-top containers for hygienic waste disposal.

- FG905800 combines the durability of plastic, a hands-free funnel top, and the fire protection of a closed top
- Heavy-duty plastic construction with molded-in color and UV inhibitors
- Textured finish helps minimize appearance of surface scratches
- Built-in side handles ease lifting
- FG905800 is FM-Approved



FG905800

No.	Color	Description	U.S. Dimensions	U.S. Capacity	U.S. Ship Wt/Ctn	Metric Dimensions	Metric Capacity	Metric Ship Wt/Ctn	Can Liners	Pack
FG905800*	BLA	Atrium® Classic Container with Funnel Top	25" dia x 33.3" h	35 gal	23.5 lb	63.5 cm dia x 84.6 cm	132.5 L	10.7 kg	5008-88 ^a	1
FG905886	WGRAN	Atrium® Classic Container with Funnel Top	25" dia x 33.3" h	35 gal	23.5 lb	63.5 cm dia x 84.6 cm	132.5 L	10.7 kg	5008-88 ^a	1

*Custom imprinting available; contact Rubbermaid Customer Service.
^aNot for sale in California.

Accents

The elegance of stone and natural wood, along with the striking effect of solid stainless steel and brass, complement tasteful interiors.

- Recommended for indoor use
- Fire-safe galvanized steel liners included
- Black and white sand available; see pg 191



FGDM12TGTM

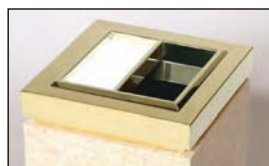
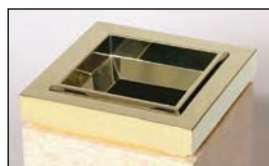

All models available with Waste-only or Ash/Trash tops.

No.	Color	Liner	Description	Capacity (Gal)	Capacity (Liters)	U.S. Dimensions	U.S. Ship Wt/Ctn	Metric Dimensions	Metric Ship Wt/Ctn
FGDM12T	GTM, MBM, SRG	GL	Accents Waste Receptacle	5	18.9	12" sq x 27.5" h	56.0 lb	30.5 cm sq x 69.9 cm	25.4 kg
FGDM12SUT	GTM, MBM, SRG	GL	Accents Ash/Trash	5	18.9	12" sq x 27.5" h	56.0 lb	30.5 cm sq x 69.9 cm	25.4 kg
FGDS12T	SBS, SSS	GL	Accents Waste Receptacle	5	18.9	12" sq x 27" h	24.0 lb	30.5 cm sq x 68.6 cm	10.9 kg
FGDS12SUT	SBS, SSS	GL	Accents Ash/Trash	5	18.9	12" sq x 27" h	25.0 lb	30.5 cm sq x 68.6 cm	11.3 kg
FGDW12SUT	MAH	GL	Accents Ash/Trash	5	18.9	12" sq x 27" h	43.0 lb	30.5 cm sq x 68.6 cm	19.35 kg
FGDW12T	MAH	GL	Accents Waste Receptacle	5	18.9	12" sq x 27" h	43.0 lb	30.5 cm sq x 68.6 cm	19.35 kg

Golden Travertine/Mirror Brass (GTM), Mahogany/Mirror Brass (MAH), Marquina Black/Mirror Chrome (MBM), Red Sierra Granite/Stainless Steel (SRG), Satin Brass Stainless Steel (SBS), Satin Stainless Steel (SSS) Galvanized Liner (GL)

Custom labeling options available, see pgs 286-291. Call Customer Service for pricing.

WHEN ORDERING PRODUCTS WITH **BOLD** COLOR CODES, PLEASE SPECIFY COLOR CODE AFTER THE PRODUCT NUMBER. SEE THE PRODUCT COLOR GUIDE AT THE BACK OF THE CATALOG.



This symbol, positioned with Decorative Receptacle refuse containers, indicates post-consumer recycled content (30% for steel, 70% for aluminum)



**Atrium®
Aluminum and Brass
Containers**

Ideal for use in airports, office buildings, and malls.

- Corrosion-resistant, heavy-gauge aluminum
- Fire-safe construction
- Highly scratch-resistant hammered silver finish
- High-quality polish on satin finish eliminates spinning lines and blemishes
- All models are corrosion-resistant, fire-safe, and ADA-compliant



Extended overlap area eliminates visible can liner overhang.



Model FGATF18 features flip top.

**CUSTOM DECAL OPTIONS
AVAILABLE, SEE PAGES 286–291.**

ATRIUM®

No.	Color	Liner	Description	Capacity (Gal)	Capacity (Liters)	U.S. Dimensions	U.S. Ship Wt/Ctn	Metric Dimensions	Metric Ship Wt/Ctn
FG907900	HSILV	N/A	Atrium® Aluminum Container Open-Top	35	132.5	18" dia x 32.25" h	32.7 lb	45.7 cm dia x 81.9 cm	14.8 kg
	SA	NL		18	68.1				
FGATF18	SB	NL	Atrium® Aluminum Container Flip-Top	18	68.1	14" dia x 27" h	20.3 lb	35.6 cm dia x 68.6 cm	9.2 kg
	SA	PL		15	56.8				
FGAOT35	SA	NL	Atrium® Aluminum Container Open-Top	35	132.5	18" dia x 32" h	39.0 lb	45.7 cm dia x 81.3 cm	17.7 kg
	SB	NL		21	79.5				
	SA	GL, PL		21	79.5				
	SB	GL, PL		21	79.5				
FGAOT62	SA	NL	Atrium® Aluminum Container Open-Top	62	234.7	24" dia x 35" h	66.0 lb	61 cm dia x 88.9 cm	29.9 kg
	SB	NL		62	234.7				
	SA	PL		55	208.2				
	SB	PL		55	208.2				

Galvanized Liner (GL), No Liner (NL), Plastic Liner (PL)
 Hammered Silver (HSILV), Satin Aluminum (SALUM/SA), Satin Brass Aluminum (SB)
 Custom labeling options available, see pgs 286–291. Call Customer Service for pricing. For replacement liners, see page 204.

Crowne Collection

The contemporary Crowne Collection features the elegant and extremely durable Textured Uni-Koat® powder-coat finish.

- Fire-safe steel and aluminum construction
- Bottom rim on all models is designed to protect floors
- FGR1536 features a self-closing door, which complies with OSHA standards, and recessed hand grips for easy lift-off emptying
- FGAOT30 and FGAOT15: can liner edge fits neatly between the rigid liner and receptacle



ADA COMPLIANT



OPEN-TOP RECEPTACLES

TEXTURED BROWN/BRASS (SBBR)



FGS017

FGS017SU

FGR1536

TEXTURED GRAY/CHROME (SCGR)



FGS017

FGS017SU

FGR1536

CROWNE COLLECTION OPEN-TOP

No.	Color	Liner	Description	Capacity (Gal)	Capacity (Liters)	U.S. Dimensions	U.S. Ship Wt/Ctn	Metric Dimensions	Metric Ship Wt/Ctn
FGAOT15	BK, SABK, SAGR, SBBR	PL	Crowne Collection Open-Top	15	56.8	15" dia x 30" h	25.0 lb	38.1 cm dia x 76.2 cm	11.3 kg
	SA	PL		15	56.8				
	SB	PL		15	56.8				
FGAOT30	BK, SABK, SAGR, SBBR	PL	Crowne Collection Open-Top	30	113.6	20" dia x 34.5" h	47.0 lb	50.8 cm dia x 87.6 cm	21.3 kg
	SA	PL		30	113.6				
	SB	PL		30	113.6				

CROWNE COLLECTION

No.	Liner	Color	Description	Capacity (Gal)	Capacity (Liters)	U.S. Dimensions	U.S. Ship Wt/Ctn	Metric Dimensions	Metric Ship Wt/Ctn
FGR1536	GL ¹ , PL	SBBR, SCGR	Crowne Steel Containers Round-Top	15	56.8	15" dia x 36" h	23.0 lb	38.1 cm dia x 91.4 cm	10.4 kg
FGS017SU	GL	SBBR, SCGR	Crowne Collection Ash/Trash	15	56.8	15" dia x 33.5" h	27.0 lb	38.1 cm dia x 85.1 cm	12.2 kg
FGS017	GL	SBBR, SCGR	Crowne Collection Flat-Top	15	56.8	15" dia x 33.5" h	27.0 lb	38.1 cm dia x 85.1 cm	12.2 kg

Galvanized Liner (GL), Plastic Liner (PL) ¹ UL-Listed, FM, CSFM

Satin Aluminum (SA), Satin Brass (SB), Textured Black (BK), Textured Black/Aluminum (SABK), Textured Brown/Brass (SBBR), Textured Gray/Aluminum (SAGR), Textured Gray/Chrome (SCGR)

Custom options available, see pgs 286–291. Call Customer Service for pricing. For replacement liners, see page 204.

WHEN ORDERING PRODUCTS WITH BOLD COLOR CODES, PLEASE SPECIFY COLOR CODE AFTER THE PRODUCT NUMBER. SEE THE PRODUCT COLOR GUIDE AT THE BACK OF THE CATALOG.



This symbol, positioned with Decorative Receptacle refuse containers, indicates post-consumer recycled content (30% for steel, 70% for aluminum).



BLACK/BRASS

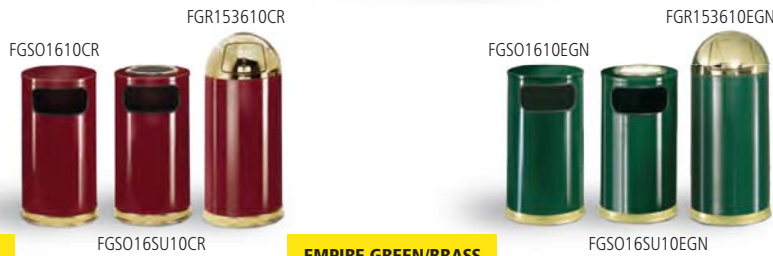

CRIMSON/BRASS

EMPIRE GREEN/BRASS



ANTHRACITE/CHROME

BLACK/CHROME

European Series
Ideally suited for upscale environments, the European Series features clean lines with elegant chrome or brass finish accents. The exceptional durability provides a low-maintenance solution for prominent areas.

- FGCC16 and FGR1536 are UL-Listed/ FM-Approved as Fire-Safe/ Self-Extinguishing
- Heavy-gauge, powder-coated, fire-safe steel
- Bottom rim on all models is designed to protect floors
- Indoor use only
- Black and white sand available; see pg 191
- Optional urn caps available; contact your Rubbermaid Commercial Products Sales Representative
- FGR1536 Round-Top features a self-closing door, which complies with OSHA standards, and recessed hand grips for easy lift-off emptying



CSFM



ADA COMPLIANT

OSHA



Half Rounds

Also available with an Open-Top (FGSO12).



FGSO810BK

FGSO8SU10CR

FGSO820ANT

FGSO8SU10EGN

No.*	Trim*	Color*	Liner	Description	Capacity (Gal)	Capacity (Liters)	U.S. Dimensions	U.S. Ship Wt/Ctn	Metric Dimensions	Metric Ship Wt/Ctn
FG1100	10	BK	PL	Steel Receptacle Ash/Trash	3.5	13.2	10" dia x 27" h	12.0 lb	25.4 cm dia x 68.6 cm	5.4 kg
FGUB1900	10	BK	N/A [‡]	Steel Wastebasket Open-Top	5	18.9	10" dia x 15" h	6.0 lb	25.4 cm dia x 38.1 cm	2.7 kg
FGSO8	10	BK, CR, EGN	PL	European Half Round	9	34.1	18" w x 32" h	26.0 lb	45.7 cm x 81.3 cm	11.8 kg
FGSO8	20	BK, EGN, ANT	PL	European Half Round	9	34.1	18" w x 32" h	26.0 lb	45.7 cm x 81.3 cm	11.8 kg
FGSO8SU	10	BK, CR, EGN	PL	European Half Round Ash/Trash	9	34.1	18" w x 32" h	26.0 lb	45.7 cm x 81.3 cm	11.8 kg
FGSO8SU	20	BK, ANT	PL	European Half Round Ash/Trash	9	34.1	18" w x 32" h	26.0 lb	45.7 cm x 81.3 cm	11.8 kg
FGSO12	20	BK	PL	European Half Round Trash Open-Top	12	45.4	18" w x 32" h	28.0 lb	45.7 cm x 81.3 cm	12.7 kg
FGSO16	10, 20	BK, CR, EGN, ANT	GL	European Flat-Top	12	45.4	15" dia x 28" h	22.0 lb	38.1 cm dia x 71.1 cm	10 kg
FGSO16SU	10, 20	BK, CR, EGN, ANT	GL	European Sand Top Ash/Trash	12	45.4	15" dia x 28" h	22.0 lb	38.1 cm dia x 71.1 cm	10 kg
FGR1536	10, 20	BK, CR, EGN, ANT	GL [Ⓔ]	Metallic Steel Container Round-Top	15	56.8	15" dia x 36" h	23.0 lb	38.1 cm dia x 91.4 cm	10.4 kg
	10, 20	BK, CR, EGN, ANT	PL		15	56.8				
FGCC16	10	BK	GL [Ⓔ]	Metallic Steel Container Open-Top	15	56.8	15" dia x 28" h	25.0 lb	38.1 cm dia x 71.1 cm	11.3 kg

*When ordering this product, please specify Trim Code and Color Code after the Product Number.

Galvanized Liner (GL), Plastic Liner (PL) Black (BK), Brass (10), Crimson (CR), Empire Green (EGN), Anthracite (ANT), Chrome (20)

[Ⓔ] UL-Classified, FM, CSFM

[‡] UL-Classified, CSFM

Custom options available on pgs 286–291. Call Customer Service for pricing. For replacement liners, see page 204.

Metallic Series

The Metallic Series offers functional litter control in an elegant design.

- FGCC16 and FGR1536 are UL-Listed/ FM-Approved as Fire-Safe/ Self-Extinguishing
- Heavy-gauge, fire-safe steel
- Protective vinyl trim on all side disposal openings
- Bottom rim on all models is designed to protect floors
- Indoor use recommended
- Black and white sand available; see pg 191
- Optional urn caps available; contact your Rubbermaid Commercial Products' Sales Representative
- FGR1536 Round-Top features a Self-closing door, which complies with OSHA standards, and recessed hand grips for easy lift-off emptying



SATIN STAINLESS STEEL



OSHA



ADA COMPLIANT

CUSTOM OPTIONS AVAILABLE, SEE PAGES 286–291.

Half Rounds



FGS012 FGS08 FGS08SU

MIRROR CHROME



FGCC16 FGR1530 FGR1536

SATIN BRASS STAINLESS STEEL

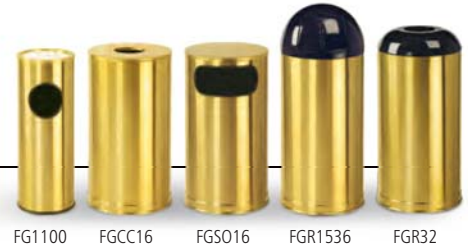

FG1100 FGCC16 FGS016 FGR1536 FGR32

No.	Color	Liner	Description	Capacity (Gal)	Capacity (Liters)	U.S. Dimensions	U.S. Ship Wt/Ctn	Metric Dimensions	Metric Ship Wt/Ctn
FG1100	SSS	PL	Ash/Trash	3.5	13.2	10" dia x 27" h	12.0 lb	25.4 cm dia x 68.6 cm	5.4 kg
	SBS	PL							
FGCC16	SSS	GL ¹	Metallic Steel Container Open-Top	15	56.8	15" dia x 28" h	25.0 lb	38.1 cm dia x 71.1 cm	11.3 kg
	SBS	GL ¹		15	56.8				
FGR1530	MC	GL ¹	Metallic Steel Container Round-Top	15	56.8	15" dia x 30" h	19.0 lb	38.1 cm dia x 76.2 cm	8.6 kg
	SSS	GL ¹ , PL		15	56.8				
FGR1536	SBS	GL ¹ , PL	Metallic Steel Container Round-Top	15	56.8	15" dia x 36" h	23.0 lb	38.1 cm dia x 91.4 cm	10.4 kg
	MC	GL ¹ , PL		15	56.8				
FGR32	SSS	GL ¹	Metallic Steel Container Open-Top	15	56.8	15" dia x 32" h	23.0 lb	38.1 cm dia x 81.3 cm	10.4 kg
	SBS	GL ¹		15	56.8				
FGS08	SSS	PL	Metallic Half Round	9	34.1	18" w x 32" h	26.0 lb	45.7 cm x 81.3 cm	11.8 kg
	SBS	PL		9	34.1				
FGS08SU	SSS	PL	Metallic Half Round Ash/Trash	9	34.1	18" w x 32" h	26.0 lb	45.7 cm x 81.3 cm	11.8 kg
	SBS	PL		9	34.1				
FGS012	SSS	PL	Metallic Steel Container Half Round Trash Open-Top	12	45.4	18" w x 32" h	28.0 lb	45.7 cm x 81.3 cm	12.7 kg
FGS016	SSS	GL	Metallic Steel Container Flat-Top	12	45.4	15" dia x 28" h	22.0 lb	38.1 cm dia x 71.1 cm	10 kg
	SBS	GL		12	45.4				
FGS016SU	SSS	GL	Ash/Trash	12	45.4	15" dia x 28" h	22.0 lb	38.1 cm dia x 71.1 cm	10 kg
	SBS	GL		12	45.4				
FGUB1900	SSS ¹	N/A	Metallic Steel Open-Top	5	18.9	10" dia x 15" h	6.0 lb	25.4 cm dia x 38.1 cm	2.7 kg

Galvanized Liner (GL), Plastic Liner (PL) ¹UL-Listed, FM, CSFM

Mirror Chrome (MC), Satin Stainless Steel (SSS), Satin Brass Stainless Steel (SBS) For replacement liners, see page 204.

WHEN ORDERING PRODUCTS WITH **BOLD** COLOR CODES, PLEASE SPECIFY COLOR CODE AFTER THE PRODUCT NUMBER. SEE THE PRODUCT COLOR GUIDE AT THE BACK OF THE CATALOG.



This symbol, positioned with Decorative Receptacle refuse containers, indicates post-consumer recycled content (30% for steel, 70% for aluminum).



FGWHB14SS

FGWHB14EBK



Hide-A-Bag

Award-winning design conceals can liner for a neat appearance.

- Fire-safe steel construction
- Noncorrosive vinyl base ring protects floors



FGWB29RSS

FGWMB30RBK

FGWMB20SL

Concept Collection™

Designer solutions for desk-side disposal.

Steel Mesh Baskets

- "No snag" curled rim protects clothing
- Baked-on epoxy finish
- Solid steel base

Stainless Steel Basket

- Brilliant satin finish
- Vinyl base ring protects floors



FG816088BEIG

FG816088OWHT

FG817088BLA

Marshal® Classic Containers

Practical good looks combined with fire safety.

- Includes retainer hardware for securing and concealing can liners
- Textured finish minimizes the appearance of surface scratches



HIDE-A-BAG

No.	Color	Description	Capacity (Gal)	Capacity (Liters)	U.S. Dimensions	U.S. Ship Wt/Ctn	Metric Dimensions	Metric Ship Wt/Ctn	Carton Quantity
FGWHB14	SS	Hide-A-Bag Open-Top Wastebasket	3.5	13.2	9.5" dia x 12.5" h	7.0 lb	24.1 cm dia x 31.8 cm	3.2 kg	
FGWHB14E	BK	Hide-A-Bag Open-Top Wastebasket	3.5	13.2	9.5" dia x 12.5" h	8.0 lb	24.1 cm dia x 31.8 cm	3.6 kg	

Black (BK), Stainless Steel (SS) See pgs 286–291 for custom labeling options. Call Customer Service for pricing.

CONCEPT COLLECTION™

No.	Color	Description	Capacity (Gal)	Capacity (Liters)	U.S. Dimensions	U.S. Ship Wt/Ctn	Metric Dimensions	Metric Ship Wt/Ctn	Carton Quantity
FGWB29R	SS	Concept Collection™ Open-Top Wastebasket	7.25	27.4	13.5" w x 15.5" h	16.0 lb	34.3 cm x 39.4 cm	7.3 kg	3
FGWMB20	BK	Concept Collection™ Open-Top Wastebasket	5	18.9	11.5" dia x 14" h	N/A	29.2 cm dia x 35.6 cm	N/A	6
	SL	Concept Collection™ Open-Top Wastebasket	5	18.9	11.5" dia x 14" h	N/A	29.2 cm dia x 35.6 cm	N/A	6
FGWMB30R	BK	Concept Collection™ Open-Top Wastebasket	7.5	28.4	16" w x 14" h	12.0 lb	40.6 cm x 35.6 cm	5.4 kg	3

Black (BK), Silver (SL), Stainless Steel (SS) See pgs 286–291 for custom labeling options. Call Customer Service for pricing.

MARSHAL® CLASSIC CONTAINERS

No.	Color	Description	Capacity (Gal)	Capacity (Liters)	U.S. Dimensions	U.S. Ship Wt/Ctn	Metric Dimensions	Metric Ship Wt/Ctn	Carton Quantity
FG816088*	BEIG, BLA, BRN, OWHT	Marshal® Classic Container	15	56.8	15.38" dia x 36.5" h	20.1 lb	39.1 cm dia x 92.7 cm	9.1 kg	4
FG817088*	BEIG, BLA, BRN, OWHT	Marshal® Classic Container	25	94.6	18" dia x 42" h	23.0 lb	45.7 cm dia x 106.7 cm	10.4 kg	4
FG355000	GRAY	Rigid Liner for FG816088 Container	12½	45.9 L	12" dia x 27.25" h	16.2 lb	30.5 cm dia x 69.2 cm	7.3 kg	4
FG355200	GRAY	Rigid Liner with Rim for FG817088 and FG818088 Container	22	83.3 L	14.5" dia x 30.13" h	26.9 lb	36.8 cm dia x 76.5 cm	12.2 kg	4

Beige (BEIG), Black (BLA), Brown (BRN), Off White (OWHT) *FM-Approved

*Custom imprinting available; contact Rubbermaid Customer Service for details.

Round-Tops

- Fire-safe steel
- Models FGR1530, FGR1536, and FGR1842 feature a reinforced Self-closing, stainless steel door that controls odors and complies with OSHA standards
- All models include recessed hand grips for easy lift-off emptying
- Noncorrosive base ring protects floors
- Galvanized steel or leak-proof rigid liner included



(When used with galvanized liner.)



CSFM



ADA COMPLIANT

OSHA



HANDS-FREE OPEN-TOPS

ROUND-TOPS

StepMaster™

Hands-free foot pedal permits insertion of waste without touching door.



ADA

OSHA



HANDS-FREE STEPMASTER™

FGR1536STEWH



FGR1536TESM

WHEN ORDERING PRODUCTS WITH **BOLD** COLOR CODES, PLEASE SPECIFY COLOR CODE AFTER THE PRODUCT NUMBER. SEE THE PRODUCT COLOR GUIDE AT THE BACK OF THE CATALOG.



Check out the items marked with this symbol for our new line of Executive Series™ products.



Steel Receptacles

- Fire-safe, powder-coated, steel
- Protective vinyl trim on all sides of disposal openings
- Noncorrosive base ring protects floors
- Optional urn caps available; contact your Rubbermaid Commercial Products' Sales Representative



CSFM



ADA COMPLIANT

OPEN-TOPS

No.	Liner	Color	Description	Capacity (Gal)	Capacity (Liters)	U.S. Dimensions	U.S. Ship Wt/Ctn	Metric Dimensions	Metric Ship Wt/Ctn
FGR1536EOT	GL, PL	BK	Steel Container Open-Top	15	56.8	15" dia x 35" h	-	38.1 cm dia x 88.9 cm	-
FGR32E	GL ¹	BK, WH	Steel Container Round-Top	15	56.8	15" dia x 32" h	23.0 lb	38.1 cm dia x 81.3 cm	10.4 kg

Galvanized Liner (GL), Plastic Liner (PL)

Black (BK), White (WH) ¹ UL-Listed, FM, CSFM

Custom options available on pgs 286–291. Call Customer Service for pricing. For replacement liners, see page 204.

ROUND-TOPS

No.	Liner	Color	Description	Capacity (Gal)	Capacity (Liters)	U.S. Dimensions	U.S. Ship Wt/Ctn	Metric Dimensions	Metric Ship Wt/Ctn
FGR1530E	GL ¹	BK, COB, RD, SPGN, WH	Steel Container Round-Top	12	45.4	15" dia x 30" h	19.0 lb	38.1 cm dia x 76.2 cm	8.6 kg
	PL	BK, COB, RD, SPGN, WH		12	45.4				
FGR1536	GL ¹ , PL	SM	Steel Container Round-Top	15	56.8	15" dia x 36" h	23.0 lb	38.1 cm dia x 91.4 cm	10.4 kg
FGR1536E	GL ¹	AL, BK, COB, RD, SPGN, WH	Steel Container Round-Top	15	56.8	15" dia x 36" h	20.0 lb	38.1 cm dia x 91.4 cm	9.1 kg
	PL	AL, BK, COB, RD, SPGN, WH		15	56.8				
FGR1842E	GL ¹ , PL	WH	Steel Container Round-Top	21	79.5	18" dia x 42" h	38.0 lb	45.7 cm dia x 106.7 cm	17.2 kg

Galvanized Liner (GL), Plastic Liner (PL) ¹ UL-Listed, FM, CSFM

Almond (AL), Black (BK), Cobalt Blue (COB), Red (RD), Silver Metallic (SM), Spruce Green (SPGN), White (WH)

Custom options available on pgs 286–291. Call Customer Service for pricing. For replacement liners, see page 204.

STEPMASTER™

No.	Liner	Color	Description	Capacity (Gal)	Capacity (Liters)	U.S. Dimensions	U.S. Ship Wt/Ctn	Metric Dimensions	Metric Ship Wt/Ctn
FGR1536STE	GL, PL	SM	StepMaster™ Round-Top	15	56.8	15" dia x 36" h	26.0 lb	38.1 cm dia x 91.4 cm	11.8 kg
	GL, PL	WH		15	56.8				

Galvanized Liner (GL), Plastic Liner (PL) Silver Metallic (SM), White (WH)

See pgs 286–291 for custom options. Call Customer Service for pricing.

STEEL RECEPTACLES

No.	Liner	Color	Description	Capacity (Gal)	Capacity (Liters)	U.S. Dimensions	U.S. Ship Wt/Ctn	Metric Dimensions	Metric Ship Wt/Ctn
FG1000E	N/A	BK	Steel Receptacle Urn	N/A	N/A	10" dia x 20" h	11.0 lb	25.4 cm dia x 50.8 cm	5 kg
FG1100E	PL	BK	Steel Receptacle Ash/Trash	3.5	13.2	10" dia x 27" h	12.0 lb	25.4 cm dia x 68.6 cm	5.4 kg
FGCC16E	GL ¹	BK	Steel Container Open-Top	15	56.8	15" dia x 28" h	25.0 lb	38.1 cm dia x 71.1 cm	11.3 kg
FGSO16SUE	GL	AL	Steel Container Ash/Trash	12	45.4	15" dia x 28" h	22.0 lb	38.1 cm dia x 71.1 cm	10 kg
FGSO16E	GL	AL	Steel Container Flat-Top	12	45.4	15" dia x 28" h	22.0 lb	38.1 cm dia x 71.1 cm	10 kg
FGUB1900E	N/A ¹	BK	Steel Receptacle Open-Top	5	18.9	10" dia x 15" h	5.0 lb	25.4 cm dia x 38.1 cm	2.3 kg

Galvanized Liner (GL), Plastic Liner (PL) Almond (AL), Black (BK) ¹ UL-Listed, FM, CSFM

Custom options available on pgs 286–291. Call Customer Service for pricing. For replacement liners, see page 204.

Milan Collection

Classical design complements any upscale décor. Perfect for hotel lobbies, shopping malls, and convention centers.

- Seamless construction
- Lift-off funnel tops for easy maintenance
- Leak-proof rigid plastic liners
- All models are available in over 31 standard colors, Fresco, Dura-Tone™, and Concrete fiberglass finishes; contact your Rubbermaid Commercial Products' Sales Representative



The Fresco Fiberglass Finish elegantly blends subtle colors and distinctive textures to achieve an antique look and feel.

- Available on the Milan Collection only
- Withstands heavy, constant use
- Offers superior resistance to stains and scratches



FGFGPF3025



Ash/Trash top on models FGFGK2936, FGFGK2736, and FGFGK2836.



Sand Urn top on models FGFGK1924 and FGFGK1824.



FGFGK2433
Available in over 31 standard colors and 3 custom finishes (see pages 288–291).

FRESCO FIBERGLASS FINISH



Portofino
FGFGK2836
Weathered Terra Cotta



Pescara
FGFGK2936
Bisque



Tuscan
FGFGK2736
Sahara



FGFGK2936 FGFGK2130 FGFGK1924



FGFGK2736 FGFGK2433 FGFGK1824

WHEN ORDERING PRODUCTS WITH **BOLD** COLOR CODES, PLEASE SPECIFY COLOR CODE AFTER THE PRODUCT NUMBER. SEE THE PRODUCT COLOR GUIDE AT THE BACK OF THE CATALOG.

Check out the items marked with this symbol for our new line of Executive Series™ products.

Tuscany Collection™
Square design reminiscent of Tuscan columns.

- Inset funnel top lifts off for easy emptying of rigid plastic liner
- Matching planters available



FGFGT2433SQ
Parchment Dura-Tone™

FGFGT2433SQ
Maroon

FGFGT-Model T
Adobe Dura-Tone™

MILAN COLLECTION

No.	Liner	Color	Description	Capacity (Gal)	Capacity (Liters)	U.S. Dimensions	U.S. Ship Wt/Ctn	Metric Dimensions	Metric Ship Wt/Ctn
FGFGK1824	PL	BISQ, SAH, WTRC	Milan Collection Tuscan Open-Top	7	26.5	18" dia x 24" h	26.0 lb	45.7 cm dia x 61 cm	11.8 kg
FGFGK1824SU	N/A	BISQ, SAH, BK	Milan Collection Tuscan Um	N/A	N/A	18" dia x 24" h	23.0 lb	45.7 cm dia x 61 cm	10.4 kg
FG993047	N/A	WTC	Milan Collection Tuscan Um	N/A	N/A	18" dia x 24" h	23.0 lb	45.7 cm dia x 61 cm	10.4 kg
FGFGK1924	PL	BISQ, SAH, WTRC	Milan Collection Pescara Open-Top	7	26.5	18.5" dia x 24" h	26.0 lb	47 cm dia x 61 cm	11.8 kg
FGFGK1924SU	N/A	BISQ, SAH, BK, BR	Milan Collection Pescara Um	N/A	N/A	18.5" dia x 24" h	23.0 lb	47 cm dia x 61 cm	10.4 kg
FGFGK2130	PL	BISQ, SAH, WTRC	Milan Collection Pescara Open-Top	15	56.8	21" dia x 30" h	42.0 lb	53.3 cm dia x 76.2 cm	19.1 kg
FGFGK2433	PL	BISQ, SAH, WTRC	Milan Collection Tuscan Open-Top	21	79.5	24" dia x 33" h	56.0 lb	61 cm dia x 83.8 cm	25.4 kg
FGFGK2736	PL	BISQ, SAH, WTRC	Milan Collection Tuscan Open-Top	33	124.9	26.5" dia x 36.25" h	94.0 lb	67.3 cm dia x 92.1 cm	42.6 kg
FGFGK2736SUT	PL	BIS, SAH	Milan Collection Tuscan Ash/Trash	33	124.9	26.5" dia x 36.25" h	94.0 lb	67.3 cm dia x 92.1 cm	42.6 kg
FG993053	PL	WTC	Milan Collection Tuscan Ash/Trash	33	124.9	26.5" dia x 36.25" h	94.0 lb	67.3 cm dia x 92.1 cm	42.6 kg
FGFGK2836	PL	BISQ, SAH, WTRC	Milan Collection Portofino Open-Top	37	140	27.5" dia x 36.25" h	94.0 lb	69.9 cm dia x 92.1 cm	42.6 kg
FGFGK2836SUT	PL	BIS, SAH, WTC	Milan Collection Portofino Ash/Trash	37	140	27.5" dia x 36.25" h	94.0 lb	69.9 cm dia x 92.1 cm	42.6 kg
FGFGK2936	PL	BISQ, SAH, WTRC	Milan Collection Pescara Open-Top	37	140	28.5" dia x 36.25" h	94.0 lb	72.4 cm dia x 92.1 cm	42.6 kg
FGFGK2936SUT	PL	BIS, SAH	Milan Collection Pescara Ash/Trash	37	140	28.5" dia x 36.25" h	94.0 lb	72.4 cm dia x 92.1 cm	42.6 kg
FG993046	PL	WTC	Milan Collection Pescara Ash/Trash	37	140	28.5" dia x 36.25" h	94.0 lb	72.4 cm dia x 92.1 cm	42.6 kg

Bisque (BIS, BISQ), Sahara (SAH), Weathered Terra Cotta (WTRC, WTC) come as standard options.
See pgs 286–291 for other available colors, finishes, and custom labeling options. Call Customer Service for pricing.

MILAN PLANTERS

No.	Liner	Color	Description	Capacity (Gal)	Capacity (Liters)	U.S. Dimensions	U.S. Ship Wt/Ctn	Metric Dimensions	Metric Ship Wt/Ctn
FGFGPF2419	N/A	BISQ, SAH	Milan Planter	N/A	N/A	24" dia x 19" h	40.0 lb	61 cm dia x 48.3 cm	18.1 kg
FGFGPF3025	N/A	BISQ, SAH	Milan Planter	N/A	N/A	30" dia x 25" h	60.0 lb	76.2 cm dia x 63.5 cm	27.2 kg
FGFGPF3626	N/A	BISQ, SAH	Milan Planter	N/A	N/A	36" dia x 26.5" h	90.0 lb	91.4 cm dia x 67.3 cm	40.8 kg

Bisque (BISQ), Sahara (SAH), Weathered Terra Cotta (WTRC, WTC) come as standard options.
See pgs 286–291 for other available colors, finishes, and custom labeling options. Call Customer Service for pricing.

TUSCANY COLLECTION™

No.	Liner	Color	Description	Capacity (Gal)	Capacity (Liters)	U.S. Dimensions	U.S. Ship Wt/Ctn	Metric Dimensions	Metric Ship Wt/Ctn
FGFGT2433SQ	PL	**	Tuscany Collection™ Square	34	128.7	24" sq x 33" h	49.0 lb	61 cm sq x 83.8 cm	22.2 kg
FGFGPT-Model T	N/A	**	Tuscany Planter	N/A	N/A	21" sq x 18" h to 36" sq x 24" h	Varies	53.3 cm sq x 45.7 cm to 91.4 cm sq x 61 cm	Varies

Plastic Liner (PL) **Gel-Coat colors are standard. See pgs 286–291 for other available colors, finishes, and custom labeling options. Call Customer Service for pricing.

Gallería

Inset funnel top or sand top lifts off for easy emptying of rigid plastic liners.

- Recessed base enables ease of cleaning
- Matching planters available; see page 203



FGFGL1824GSU
Parchment

FGFGL2730GSUT
Charcoal

FGFGL2730GT
White

Open-Tops

Two-piece design features lift-off top with vinyl trim that keeps receptacle edges looking new.

- Recessed base prevents scuffing from traffic
- Models with brass or aluminum tops add distinctive look that enhances décor
- Folding retainer bands keep can liners in place



FGFG1829TSA
Satin Aluminum /
Midnight

FGFG2432
Almond

FGFG2438
Black

FGFG2432TSA
Satin Aluminum / Plum

FGFG1630TSB
Satin Brass / Hunter Green

FGFG2032
Warm Gray

FGFG2432
Burgundy Wine

FGFG1630SQT
Terra Cotta

FGFG1829T
Black

FGFG1630T
Tan

WHEN ORDERING PRODUCTS WITH **BOLD** COLOR CODES, PLEASE SPECIFY COLOR CODE AFTER THE PRODUCT NUMBER. SEE THE PRODUCT COLOR GUIDE AT THE BACK OF THE CATALOG.



Check out the items marked with this symbol for our new line of Executive Series™ products.



Cornerstone Series™
 Cornerstone Series™ models shown with concrete Fiberglass Finish. Also available with Dura-Tone™ Fiberglass Finish.



FGFGC2044
Pebble

FGFGC2446WU
Sand

FGFGC1630T
Slate

FGFGC2035T
Pebble

FGFGC1639
Slate

GALLERÍA

No.	Liner	Color	Description	Capacity (Gal)	Capacity (Liters)	U.S. Dimensions	U.S. Ship Wt/Ctn	Metric Dimensions	Metric Ship Wt/Ctn
FGFGL1824GSU	N/A	**	Gallería Sand-Top Um	N/A	N/A	18" dia x 24" h	14.0 lb	45.7 cm dia x 61 cm	6.4 kg
FGFGL2730GSUT	PL*	**	Gallería Sand-Top Ash/Trash	22	83.3	18" dia x 24" h	37.0 lb	45.7 cm dia x 61 cm	16.8 kg
FGFGL2730GT	PL*	**	Gallería Receptacle	22	83.3	27" dia x 30" h	37.0 lb	68.6 cm dia x 76.2 cm	16.8 kg

*Plastic Liner (PL) is standard. For Galvanized Liner or Retainer Bands, call Customer Service.

**Gel-Coat colors are standard. See pgs 286–291 for other available colors, finishes, and labeling options. Call Customer Service for pricing.

OPEN-TOPS

No.	Liner	Color	Description	Capacity (Gal)	Capacity (Liters)	U.S. Dimensions	U.S. Ship Wt/Ctn	Metric Dimensions	Metric Ship Wt/Ctn
FGFG1630T	PL*	**	Open-Top Round	15	56.8	16" dia x 28" h	25.0 lb	40.6 cm dia x 71.1 cm	11.3 kg
FGFG1630SQT	PL*	**	Open-Top Square	20	75.7	16" sq x 30" h	38.0 lb	40.6 cm sq x 76.2 cm	17.2 kg
FGFG1630TSA	PL*	**	Open-Top with Satin Aluminum Top	15	56.8	16" dia x 30" h	22.0 lb	40.6 cm dia x 76.2 cm	10 kg
FGFG1630TSB	PL*	**	Open-Top with Satin Brass Top	15	56.8	16" dia x 30" h	22.0 lb	40.6 cm dia x 76.2 cm	10 kg
FGFG1829T	PL*	**	Open-Top Round	20	75.7	18" dia x 29" h	29.0 lb	45.7 cm dia x 73.7 cm	13.2 kg
FGFG1829TSA	PL*	**	Open-Top with Satin Aluminum Top	20	75.7	18" dia x 29" h	28.0 lb	45.7 cm dia x 73.7 cm	12.7 kg
FGFG1829TSB	PL*	**	Open-Top with Satin Brass Top	20	75.7	18" dia x 29" h	28.0 lb	45.7 cm dia x 73.7 cm	12.7 kg
FGFG2030SQT	PL*	**	Open-Top Square	29	109.8	20" sq x 30" h	33.0 lb	50.8 cm sq x 76.2 cm	15 kg
FGFG2032	PL*	**	Open-Top Round	26	98.4	20" dia x 32" h	27.0 lb	50.8 cm dia x 81.3 cm	12.2 kg
FGFG2432	PL*	**	Open-Top Round	36	121.1	24" dia x 32" h	51.0 lb	61 cm dia x 81.3 cm	23.1 kg
FGFG2432TSA	PL*	**	Open-Top with Satin Aluminum Top	32	121.1	24" dia x 32" h	46.0 lb	61 cm dia x 81.3 cm	20.9 kg
FGFG2432TSB	PL*	**	Open-Top with Satin Brass Top	32	121.1	24" dia x 32" h	46.0 lb	61 cm dia x 81.3 cm	20.9 kg
FGFG2438	PL*	**	Open-Top Round	50	189.3	24" dia x 39" h	53.0 lb	61 cm dia x 99.1 cm	24 kg

*Plastic Liner (PL) is standard. For Galvanized Liner or Retainer Bands, call Customer Service.

**Gel-Coat colors are standard. See pgs 286–291 for other available color, finishes, and labeling options. Call Customer Service for pricing. For replacement liners, see page 204.

CORNERSTONE SERIES™

No.	Liner	Color	Description	Capacity (Gal)	Capacity (Liters)	U.S. Dimensions	U.S. Ship Wt/Ctn	Metric Dimensions	Metric Ship Wt/Ctn
FGFGC1630T	PL*	Concrete***	Cornerstone Series™ Open-Top	15	56.8	16" dia x 30" h	22.0 lb	40.6 cm dia x 76.2 cm	10 kg
FGFGC1639	PL*	Concrete***	Cornerstone Series™ Covered-Top	15	56.8	16" dia x 39" h	26.0 lb	40.6 cm dia x 99.1 cm	11.8 kg
FGFGC2035T	PL*	Concrete***	Cornerstone Series™ Open-Top	23	87.1	20" dia x 36" h	40.0 lb	50.8 cm dia x 91.4 cm	18.1 kg
FGFGC2044	PL*	Concrete***	Cornerstone Series™ Covered-Top	23	87.1	20" dia x 46" h	47.0 lb	50.8 cm dia x 116.8 cm	21.3 kg
FGFGC2437T	PL*	Concrete***	Cornerstone Series™ Open-Top	40	151.4	24" dia x 37" h	65.0 lb	61 cm dia x 94 cm	29.5 kg
FGFGC2446	PL*	Concrete***	Cornerstone Series™ Covered-Top	40	151.4	24" dia x 46" h	75.0 lb	61 cm dia x 116.8 cm	34 kg
FGFGC2446WU	PL*	Concrete***	Cornerstone Series™ Covered-Top w/ Weather Um	40	151.4	24" dia x 49" h	75.0 lb	61 cm dia x 124.5 cm	34 kg

*Plastic Liner (PL) is standard. For Galvanized Liner or Retainer Bands, call Customer Service.

***Concrete Finish is standard. See pgs 295–291 for other available colors, finishes, and labeling options. Call Customer Service for pricing. For replacement liners, see page 204.

Foodcourt

- Keep foodservice areas neat with tray-top receptacles
- Available with single or dual disposal openings, without doors
- Available with doors as a special custom order



ADA COMPLIANT



FGFG2439TR
Tan



FGFG2037SQTR
Hunter Green

FIBERGLASS FOODCOURT

No.	Liner	Color	Description	Capacity (Gal)	Capacity (Liters)	U.S. Dimensions	U.S. Ship Wt/Ctn	Metric Dimensions	Metric Ship Wt/Ctn
FGFG2037SQTR	PL*	**	Foodcourt Covered Tray Top	29	109.8	20" sq x 36" h	53.0 lb	50.8 cm sq x 91.4 cm	24 kg
FGFG2438SQTR	PL*	**	Foodcourt Covered Tray Top	40	151.4	24" sq x 38" h	53.0 lb	61 cm sq x 96.5 cm	24 kg
FGFG2439TR	PL*	**	Foodcourt Covered Tray Top	32	121.1	24" dia x 39" h	50.0 lb	61 cm dia x 99.1 cm	22.7 kg

*Plastic Liner (PL) is standard. For Galvanized Liner or Retainer Bands, call Customer Service.

See pages 286–291 for other available colors, finishes, and labeling options. Call Customer Service for pricing. For replacement liners, see page 204.

***Dura-Tone™ and concrete finishes only.

WHEN ORDERING PRODUCTS WITH **BOLD** COLOR CODES, PLEASE SPECIFY COLOR CODE AFTER THE PRODUCT NUMBER. SEE THE PRODUCT COLOR GUIDE AT THE BACK OF THE CATALOG.



Check out the items marked with this symbol for our new line of Executive Series™ products.

Covered-Tops



FGFG2438SQ
Dark Brown

FGFG2439
Navy

FGFG1639
Ivory

COVERED-TOPS

No.	Liner	Color	Description	Capacity (Gal)	Capacity (Liters)	U.S. Dimensions	U.S. Ship Wt/Ctn	Metric Dimensions	Metric Ship Wt/Ctn
FGFG1639	PL*	**	Covered-Top Round	15	56.8	16" dia x 37" h	24.0 lb	40.6 cm dia x 94 cm	10.9 kg
FGFG1837	PL*	**	Covered-Top Round	20	75.7	18" dia x 37" h	42.0 lb	45.7 cm dia x 94 cm	19.1 kg
FGFG2038SQ	PL*	**	Covered-Top Square	29	109.8	20" sq x 37" h	53.0 lb	50.8 cm sq x 94 cm	24 kg
FGFG2438SQ	PL*	**	Covered-Top Square	40	151.4	24" sq x 38" h	53.0 lb	61 cm sq x 96.5 cm	24 kg
FGFG2439	PL*	**	Covered-Top Round	32	121.1	24" dia x 39" h	50.0 lb	61 cm dia x 99.1 cm	22.7 kg

* Plastic Liner (PL) is standard. For Galvanized Liner or Retainer Bands, call Customer Service.

**Gel-Coat colors are standard. See pgs 286–291 for other available colors, finishes, and labeling options. Call Customer Service for pricing. For replacement liners, see page 204.

***Dura-Tone™ and concrete finishes only.

Ash/Trash

Contemporary dual-purpose ash/trash receptacles save space and help keep areas clean.

- Vinyl trim on all edges prevents chipping
- Urn sand available; see page 191

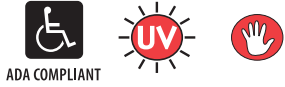

FGFG2432SQSUT
Light Gray



FGFG1227SU
Charcoal



FGFG1630SQSUT
Eggplant



FGFG1837SU
Rose Gran-x™



FGFG1630SUT
Maroon



Half Rounds

- Reduces obstruction in high-traffic areas
- Provides waste control in areas where space is limited
- Removable sand pan for easy maintenance
- Protective vinyl trim on disposal openings and edges
- Optional black or white sand; see page 191



FGFGH2436
Burgundy Wine



FGFGH2436SU
Gray Gran-x™



FGFGH2436SUT
Black

WHEN ORDERING PRODUCTS WITH **BOLD** COLOR CODES, PLEASE SPECIFY COLOR CODE AFTER THE PRODUCT NUMBER. SEE THE PRODUCT COLOR GUIDE AT THE BACK OF THE CATALOG.



Check out the items marked with this symbol for our new line of Executive Series™ products.



One-Piece Lift-Off
One-piece lift-off design speeds maintenance.

- Hides unsightly bag overhang

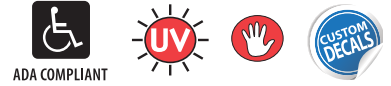

FIBERGLASS ASH/TRASH

No.	Liner	Color	Description	Capacity (Gal)	Capacity (Liters)	U.S. Dimensions	U.S. Ship Wt/Ctn	Metric Dimensions	Metric Ship Wt/Ctn
FGFG1227SU	PL*	**	Fiberglass Ash/Trash Container Sand Top	6.5	24.6	12" dia x 27" h	16.0 lb	30.5 cm dia x 68.6 cm	7.3 kg
FGFG1227FT	PL*	**	Fiberglass Ash/Trash Container Funnel Top	6.5	24.6	12" dia x 27" h	16.0 lb	30.5 cm dia x 68.6 cm	7.3 kg
FGFG1630SUT	PL*	**	Fiberglass Ash/Trash Container Sand Top	15	56.8	16" dia x 28" h	25.0 lb	40.6 cm dia x 71.1 cm	11.3 kg
FGFG1639SU	PL*	**	Fiberglass Ash/Trash Container Covered-Top	15	56.8	16" dia x 37" h	24.0 lb	40.6 cm dia x 94 cm	10.9 kg
FGFG1837SU	PL*	**	Fiberglass Ash/Trash Container Covered-Top	20	75.7	18" dia x 37" h	36.0 lb	45.7 cm dia x 94 cm	16.3 kg
FGFG1630SQSUT	PL*	**	Fiberglass Ash/Trash Container Sand Top	20	75.7	16" sq x 30" h	42.0 lb	40.6 cm sq x 76.2 cm	19.1 kg
FGFG2432SQSUT	PL*	**	Fiberglass Ash/Trash Container Sand Top	40	151.4	24" sq x 32" h	53.0 lb	61 cm sq x 81.3 cm	24 kg

**Gel-Coat colors are standard. See pgs 286–291 for other available colors, finishes, and labeling options. Call Customer Service for pricing. For replacement liners, see page 204.

FIBERGLASS HALF ROUND

No.	Liner	Color	Description	Capacity (Gal)	Capacity (Liters)	U.S. Dimensions	U.S. Ship Wt/Ctn	Metric Dimensions	Metric Ship Wt/Ctn
FGFGH2436	PL*	**	Half Round Open Front	18	68.1	24" dia x 36" h	28.0 lb	61 cm dia x 91.4 cm	12.7 kg
FGFGH2436SU	PL*	**	Fiberglass Ash/Trash Container Half Round Open Front	18	68.1	24" dia x 36" h	28.0 lb	61 cm dia x 91.4 cm	12.7 kg
FGFGH2436SUT	PL*	**	Fiberglass Ash/Trash Container Half Round Open-Top	24	90.8	24" dia x 36" h	30.0 lb	61 cm dia x 91.4 cm	13.6 kg

*Plastic Liner (PL) is standard. For Galvanized Liner or Retainer Bands, call Customer Service.

**Gel-Coat colors are standard. See pgs 286–291 for other available colors, finishes, and labeling options. Call Customer Service for pricing. For replacement liners, see page 204.

FIBERGLASS ONE-PIECE LIFT-OFF

No.	Liner	Color	Description	Capacity (Gal)	Capacity (Liters)	U.S. Dimensions	U.S. Ship Wt/Ctn	Metric Dimensions	Metric Ship Wt/Ctn
FGFG1219LO	PL*	**	Fiberglass One-Piece Lift-Off	6.5	24.6	12" dia x 19" h	11.0 lb	30.5 cm dia x 48.3 cm	5 kg
FGFG1628LO	PL*	**	Fiberglass One-Piece Lift-Off	15	56.8	16" dia x 28" h	22.0 lb	40.6 cm dia x 71.1 cm	10 kg
FGFG1830LO	PL*	**	Fiberglass One-Piece Lift-Off	21	79.5	18" dia x 30" h	27.0 lb	45.7 cm dia x 76.2 cm	12.2 kg

*Plastic Liner (PL) is standard. For Galvanized Liner or Retainer Bands, call Customer Service.

**Gel-Coat colors are standard. See pgs 286–291 for other available colors, finishes, and labeling options. Call Customer Service for pricing. For replacement liners, see page 204.



Fiberglass Recycling Containers

Choose the design that best suits your unique requirements and customize to match your décor.

- All models available in over 31 standard colors and Dura-Tone™ finishes; call your Rubbermaid Commercial Products Sales Representative
- Lift-off tops provide easy access to galvanized steel or leak-proof rigid plastic liners

Recycling Centers

- Centers feature an array of use-specific openings
- Curved top prevents placement of objects on top of receptacles
- Flat-top models and custom disposal openings available

Recycling Singles

- Perfect for individual placement or as a group
- Open-Top trash models available on page 170

RECYCLING CENTERS



RECYCLING SINGLES



ADA COMPLIANT



CUSTOM DECAL OPTIONS AVAILABLE, SEE PAGES 286-291.

FIBERGLASS RECYCLING CONTAINERS

No.	Color	Liner	Description	Capacity (Gal)	Capacity (Liters)	U.S. Dimensions	U.S. Ship Wt/Ctn	Metric Dimensions	Metric Ship Wt/Ctn
FGFG1630C	**	PL*	Fiberglass Recycling Container – Can	15	56.8	16" dia x 28" h	25.0 lb	40.6 cm dia x 71.1 cm	11.3 kg
FGFG1630SQC	**	PL*	Fiberglass Recycling Container – Can	20	75.7	16" sq x 30" h	38.0 lb	40.6 cm sq x 76.2 cm	17.2 kg
FGFG1829C	**	PL*	Fiberglass Recycling Container – Can	20	75.7	18" dia x 29" h	29.0 lb	45.7 cm dia x 73.7 cm	13.2 kg
FGFG1630P	**	PL*	Fiberglass Recycling Container – Paper	15	56.8	16" dia x 28" h	25.0 lb	40.6 cm dia x 71.1 cm	11.3 kg
FGFG1630SQP	**	PL*	Fiberglass Recycling Container – Paper	20	75.7	16" sq x 30" h	38.0 lb	40.6 cm sq x 76.2 cm	17.2 kg
FGFG1829P	**	PL*	Fiberglass Recycling Container – Paper	20	75.7	18" dia x 29" h	29.0 lb	45.7 cm dia x 73.7 cm	13.2 kg

*Plastic Liner (PL) is standard. For Galvanized Liner or Retainer Bands, call Customer Service.

**Gel-Coat colors are standard. See pgs 286–291 for other available colors, finishes, and labeling options. Call Customer Service for pricing. For replacement liners, see page 204.

FIBERGLASS RECYCLING CENTERS

No.	Color	Liner	Description	Capacity (Gal)	Capacity (Liters)	U.S. Dimensions	U.S. Ship Wt/Ctn	Metric Dimensions	Metric Ship Wt/Ctn
FGFR2416TP	**	PL*	Fiberglass 2-Section Recycling Center	(2) 16	(2) 60.6	24" w x 28" h	47.0 lb	61 cm x 71.1 cm	21.3 kg
FGFR3616TPC	**	PL*	Fiberglass 3-Section Recycling Center	(3) 16	(3) 60.8	36" w x 28" h	70.0 lb	91.4 cm x 71.1 cm	31.8 kg
FGFR4816TGPC	**	GL	Fiberglass 4-section Recycling Center	(2) 9, (2) 16	(2) 34, (2) 60.9	48" w x 28" h	78.0 lb	121.9 cm x 71.1 cm	35.4 kg
FGFR3418TC	**	PL	Fiberglass Large-Capacity 2-Section Recycling Center	(2) 23	(2) 87	34" w x 31" h	63.0 lb	86.4 cm x 78.7 cm	28.6 kg
FGFR3418TP	**	PL	Fiberglass Large-Capacity 2-Section Recycling Center	(2) 23	(2) 88	34" w x 31" h	63.0 lb	86.4 cm x 78.7 cm	28.6 kg
FGFR5220	**	PL	Fiberglass Shapes Recycling Center	21, 15, 23	79.5, 56.8, 87	52" w x 37.5" h	70.0 lb	132.1 cm x 95.3 cm	31.8 kg

*Plastic Liner (PL) is standard. For Galvanized Liner or Retainer Bands, call Customer Service.

**Gel-Coat colors are standard. See pgs 286–291 for other available colors, finishes, and labeling options. Call Customer Service for pricing. For replacement liners, see page 204.

WHEN ORDERING PRODUCTS WITH **BOLD** COLOR CODES, PLEASE SPECIFY COLOR CODE AFTER THE PRODUCT NUMBER. SEE THE PRODUCT COLOR GUIDE AT THE BACK OF THE CATALOG.



Check out the items marked with this symbol for our new line of Executive Series™ products.

Collect-A-Cubes™

Receptacles tailored to your specific waste, recycling, and security needs. Customizable: simply select from three base sizes, three lid types, and the type of decal desired.

- Fire-safe steel
- Shipped fully assembled
- Meet federal specification A-A-182 for fire hazard and flammability prevention
- Can be used individually, side by side, or grouped



FGNC24P5

FGNC30C2

FGNC36W4



Paper Only locked top supports HIPAA compliance.

STEP 1

No.	Color	Description	U.S. Dimensions	U.S. Ship Wt/Ctn	Metric Dimensions	Metric Ship Wt/Ctn	Liner	Capacity (Gal)	Capacity (Liters)
FGNC24	BEIGE	Collect-A-Cubes™ Recycling Cube	15.75" sq x 24" h	28.0 lb	40 cm sq x 61 cm	12.7 kg	RB	22.5	85.2
FGNC30	BEIGE	Collect-A-Cubes™ Recycling Cube	15.75" sq x 30" h	32.0 lb	40 cm sq x 76.2 cm	14.5 kg	RB	28.5	107.9
FGNC36	BEIGE	Collect-A-Cubes™ Recycling Cube	15.75" sq x 36" h	36.0 lb	40 cm sq x 91.4 cm	16.3 kg	RB	34.5	130.6
FGNC24L	BEIGE	Collect-A-Cubes™ Recycling Cube w/ Lock	15.75" sq x 24" h	28.0 lb	40 cm sq x 61 cm	12.7 kg	RB	22.5	85.2
FGNC30L	BEIGE	Collect-A-Cubes™ Recycling Cube w/ Lock	15.75" sq x 30" h	32.0 lb	40 cm sq x 76.2 cm	14.5 kg	RB	28.5	107.9
FGNC36L	BEIGE	Collect-A-Cubes™ Recycling Cube w/ Lock	15.75" sq x 36" h	36.0 lb	40 cm sq x 91.4 cm	16.3 kg	RB	34.5	130.6

Retainer Bands Only (RB)

CUSTOM COLORS AND GRAPHICS



For custom ordering and optional decals, contact your Rubbermaid Commercial Products' Sales Representative.

STEP 2 – SELECT A LID

- Powder-coated finish (Beige body with Architectural Bronze top)
- Protective vinyl trim on all disposal openings



CAN LID – MODEL C
Opening 3.5" Dia.



PAPER LID – MODEL P
Opening 2" x 14"



WASTE LID – MODEL W
Opening 8.75" Dia.

STEP 3 – SELECT A DECAL

Each set includes 4 vinyl, self-adhesive decals.

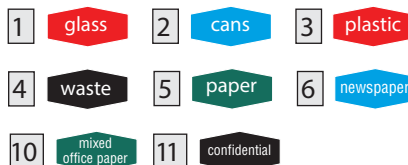

EXAMPLE ORDER NUMBER

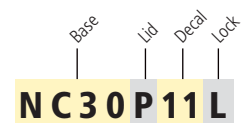

WeatherGard® Series

Architectural heavy-duty steel construction.

- Steel cable mechanism secures lid to container to help prevent theft
- Adjustable feet stabilize the container on uneven surfaces
- Steel construction
- UV-stabilized powder-coat finish
- No assembly required



FG402000

FG402100



Molded-in handles provide easy removal of a BRUTE® Rigid Liner.

Avenue

Steel mesh detailing and wide vertical rails for a sophisticated, high-capacity waste management solution.

- FGMHR36's rectangular design fits flush against walls and occupies minimal space on sidewalks, yet provides a large 36-gallon capacity
- Heavy-gauge, hot-dipped galvanized, fire-safe steel
- C-Channel rails are fabricated from 16-gauge steel
- Weatherproof, Uni-Koat® powder-coated finish
- Retainer bands hold can liners securely out of sight
- Leak-proof rigid plastic liners included
- Round containers feature cable-secured lids; rectangular and square containers feature piano-Hinged-Tops
- Leg levelers provide stability on uneven surfaces
- Anchoring kits available (see page 287); call 800-347-9800 for more information
- No assembly required



FG4024BK

FGMH46BK

FGMHR36BK

FGMH32BK

FGMHSQ18BK



CUSTOM LASER-CUT DECALS

Available with laser-cut custom graphics and in custom colors.



Easy-to-empty Hinged-Top on models FGMHSQ18 and FGMHR36.

WHEN ORDERING PRODUCTS WITH **BOLD** COLOR CODES, PLEASE SPECIFY COLOR CODE AFTER THE PRODUCT NUMBER. SEE THE PRODUCT COLOR GUIDE AT THE BACK OF THE CATALOG.



This symbol, positioned with Decorative Receptacle refuse containers, indicates post-consumer recycled content (30% for steel, 70% for aluminum).



Americana Series™

Rugged steel with multiple layers of powder coating to ensure years of trouble-free outdoor use.

- Extremely heavy to deter theft and withstand harsh weather conditions
- Vandal-resistant, cable-secured funnel and sand tops
- Durable ABS plastic UV-protected lid
- Sealed welds for durability
- Adjustable leg levelers for stability on uneven surfaces
- Optional anchoring kits available; contact your Rubbermaid Commercial Products' Sales Representative
- No assembly required



ADA COMPLIANT



Optional dome lids available for models FGMT22 and FGMT32; see pg 150.

WEATHERGARD®

No.	Color	Liner	Description	Capacity (gal)	Capacity (Liters)	U.S. Dimensions	U.S. Ship Wt/Ctn	Metric Dimensions	Metric Ship Wt/Ctn
FG402000	BLA	PL	WeatherGard® Series Container with 20 U.S. gal (75.7 L) BRUTE® Container Rigid Liner	20	75.7	27.25" dia x 27.5" h	73.7 lb	69.2 cm dia x 69.9 cm	33.4 kg
FG402100	BLA	PL	WeatherGard® Series Container with 32 U.S. gal (121.1 L) BRUTE® Container Rigid Liner	32	121.1	30.13" dia x 32" h	98.9 lb	76.5 cm dia x 81.3 cm	44.9 kg

Black (BLA)

AVENUE

No.	Liner	Color	Description	Capacity (gal)	Capacity (Liters)	U.S. Dimensions	U.S. Ship Wt/Ctn	Metric Dimensions	Metric Ship Wt/Ctn
FGMH24	PL	BK	Avenue Open-Top	23	87.1	20.5" dia x 33.5" h	73.0 lb	52.1 cm dia x 85.1 cm	33.1 kg
FGMH32	PL	BK	Avenue Round Open-Top	32	121.1	22.5" dia x 31" h	73.0 lb	57.2 cm dia x 78.7 cm	33.1 kg
FGMH46	PL	BK	Avenue Open-Top	37	140	24.5" dia x 33.5" h	89.0 lb	62.2 cm dia x 85.1 cm	40.4 kg
FGMHR36	PL	BK	Avenue Open-Top	35	132.5	29.5" l x 16" w x 32.5" h	104.0 lb	74.9 cm x 40.6 cm x 82.6 cm	47.2 kg
FGMHSQ18	PL	BK	Avenue Open-Top	16	60.6	16" l x 16" w x 32.5" h	72.0 lb	40.6 cm x 40.6 cm x 82.6 cm	32.7 kg

Black (BK) Plastic Liner (PL)

Custom colors and other custom options on pgs 286–291. Call Customer Service for pricing. For replacement liners, see page 204.

AMERICANA SERIES™

No.	Liner	Color	Description	Capacity (gal)	Capacity (Liters)	U.S. Dimensions	U.S. Ship Wt/Ctn	Metric Dimensions	Metric Ship Wt/Ctn
FGMT12	GL	ABZ, BK, VSGN	Americana Series™ Urn	N/A	N/A	17" dia x 25.75" h	60.0 lb	43.2 cm dia x 65.4 cm	27.2 kg
FGMT22	PL	ABZ, BK, VSGN	Americana Series™ Open-Top	24	90.8	25.5" dia x 25.5" h	104.0 lb	64.8 cm dia x 64.8 cm	47.2 kg
FGMT32	PL	ABZ, BK, VSGN	Americana Series™ Open-Top	36	136.3	29" dia x 32.5" h	140.0 lb	73.7 cm dia x 82.6 cm	63.5 kg

Architectural Bronze (ABZ), Black (BK), Green (GN), Green (VSGN) Galvanized Liner (GL), Plastic Liner (PL) For replacement liners, see page 204.

Architek®

The forefront of design; the reputation of reliability.

Contoured lines and layered dimensions provide an architectural style suitable for upscale environments.



Leak-Proof Rigid Plastic Liner Included



FGA38SDABZ



FGA38TSDBK

SIDE-DOOR OPTION

An ergonomic system for safe and easy emptying. Available in Drop-In and Canopy Top models.

FGA38BK



FGA17ABZ

FGA17SUBK



FGA38TBK

FGA50SUABZ



FGA51SUBK



■ Top attached with heavy-duty stainless steel hinge.

■ Unique liner design allows can liner edges to fit neatly between the leak-proof rigid liner and receptacle.

■ Durable heavy-gauge, hot-dipped galvanized, fire-safe construction with weather-proof Uni-Koat® powder-coat finish.

Standard Features

- Indoor/outdoor use
- Adjustable leg levelers raise receptacle and provide stability on uneven surfaces
- No assembly required

WHEN ORDERING PRODUCTS WITH **BOLD** COLOR CODES, PLEASE SPECIFY COLOR CODE AFTER THE PRODUCT NUMBER. SEE THE PRODUCT COLOR GUIDE AT THE BACK OF THE CATALOG.



This symbol, positioned with Decorative Receptacle refuse containers, indicates post-consumer recycled content (30% for steel, 70% for aluminum).



Custom colors and logos shown.

**Architek®
Custom Options**

Custom Color Options

Architek® models are available in a variety of powder-coated color combinations to match your specific color scheme.

- Stadiums and arenas
- Corporate parks
- Shopping malls
- Site scapes
- Recreational facilities
- Hotels

Laser-Cut Panels

Prominently display your logo with one or more custom panels.

Other Custom Options

- Vinyl Decals
- Silk-Screening

For more information contact your Rubbermaid Commercial Products' Sales Representative.



FGA38SU—Sand Top Urn



**REQUEST OUR CUSTOM SOLUTIONS
BROCHURE FOR THE COMPLETE LIST
OF CUSTOM OPTIONS.**

No.	Color	Liner	Description	Capacity (gal)	Capacity (Liters)	U.S. Dimensions	U.S. Ship Wt/Ctn	Metric Dimensions	Metric Ship Wt/Ctn
FGA17	ABZ, BK	PL	Architek® Radius Top	17	64.3	18" dia x 34" h	65.0 lb	45.7 cm dia x 86.4 cm	29.5 kg
FGA17SU	ABZ, BK	PL	Architek® Radius Urn Top	17	64.3	18" dia x 34" h	67.0 lb	45.7 cm dia x 86.4 cm	30.4 kg
FGA51SU	ABZ, BK	PL	Architek® Radius Urn Top	5	18.9	12" dia x 24" h	30.0 lb	30.5 cm dia x 61 cm	13.6 kg
FGA38	ABZ, BK	PL	Architek® Canopy Top	38	143.8	24" dia x 43" h	115.0 lb	61 cm dia x 109.2 cm	52.2 kg
FGA38SD	ABZ, BK	PL	Architek® Canopy Top with Side Door	38	143.8	24" dia x 43" h	116.0 lb	61 cm dia x 109.2 cm	52.6 kg
FGA38SU	ABZ, BK	PL	Architek® Canopy Top with Urn	38	143.8	24" dia x 43" h	115.0 lb	61 cm dia x 109.2 cm	52.2 kg
FGA38T	ABZ, BK	PL	Architek® Drop-In Top	38	143.8	24" dia x 35" h	114.0 lb	61 cm dia x 88.9 cm	51.7 kg
FGA38TSD	ABZ, BK	PL	Architek® Drop-In Top with Side Door	38	143.8	24" dia x 35" h	113.0 lb	61 cm dia x 88.9 cm	51.3 kg
FGA50SU	ABZ, BK	N/A	Architek® Urn	N/A	N/A	12" dia x 24" h	30.0 lb	30.5 cm dia x 61 cm	13.6 kg

Architectural Bronze/Sand (ABZ), Black/Anthracite (BK) Plastic Liner (PL)

Custom colors and other custom options on pgs 286–291. Call Customer Service for pricing.

Infinity™ Decorative Receptacle Containers
 Stylish containers with plastic/metal construction for unparalleled durability.

- Highly aesthetic design with automotive paint finish for facility image enhancement
- Available with perforated or solid panels
- Modular components allow easy refurbishing
- Ships knocked down for greater cube efficiency and lower freight
- ABS resin base will not scratch surfaces or leave rust stains
- Custom color options available
- Panels on square containers can be reversed for twice the life
- Can liner strap keeps liner securely attached



32-Gal Round Perforated with Dome Top (FG9W4400 / FG9W5400, Standard Color: Silver)
 35-Gal Square Perforated with Funnel Top (FG9W3700 / FG9W5000, Custom Color: Black)
 50-Gal Square Perforated with Dome Top (FG9W3800 / FG9W5100, Custom Color: Blue Streak)



Above: 35-Gal Square Perforated with Dome Top (FG9W3800 / FG9W5000, Standard Color: Bronze)
 Left: 32-Gal Round Perforated with Dome Top (FG9W4400 / FG9W5400, Standard Color: Dark Green)

WHEN ORDERING PRODUCTS WITH **BOLD** COLOR CODES,
 PLEASE SPECIFY COLOR CODE AFTER THE PRODUCT NUMBER.
 SEE THE PRODUCT COLOR GUIDE AT THE BACK OF THE CATALOG.



Check out the items marked with this symbol for our new line of Executive Series™ products.

AVAILABLE IN:

35-Gallon and 50-Gallon
 Solid and Perforated Panels
 Dome or Funnel Top
 Custom Colors
 Custom Screen-Printing or Vinyl



AVAILABLE IN:

32-Gallon
 Solid and Perforated Panels
 Dome or Funnel Top
 Custom Colors
 Custom Screen-Printing or Vinyl



Square Containers

STEP 1—FRAME KITS – TOP AND BASE

No.	Color	Description	Capacity (Gal)	Capacity (Liters)	U.S. Dimensions	U.S. Ship Wt/Ctn	Metric Dimensions	Metric Ship Wt/Ctn
FG9W3700	BLA	Square Funnel Top Frame	35	132.5	23.5" l x 23.5" w x 33" h	54.5 lb	59.7 cm x 59.7 cm x 83.8 cm	24.7 kg
			50	189.3	23.5" l x 23.5" w x 39" h	54.5 lb	59.7 cm x 59.7 cm x 99 cm	24.7 kg
FG9W3800	BLA	Square Dome Top Frame	35	189.3	23.5" l x 23.5" w x 41" h	63.0 lb	59.7 cm x 59.7 cm x 104.1 cm	28.6 kg
			50	189.3	23.5" l x 23.5" w x 47" h	63.0 lb	59.7 cm X 59.7 cm X 119.3 cm	28.6 kg

STEP 2—PANEL KITS – PANELS AND POSTS

No.	Color	Description	Capacity (Gal)	Capacity (Liters)	U.S. Dimensions	U.S. Ship Wt/Ctn	Metric Dimensions	Metric Ship Wt/Ctn
FG9W5000 ^{PA}	SILV, DGRN, BRNZ	35-Gal Perforated Square Panel Kit	35	132.5 L	29.13" sq x 19.75" w	40.0 lb	74 cm sq x 50.2 cm	18.1 kg
FG9W5100 ^{PA}	SILV, DGRN, BRNZ	50-Gal Perforated Square Panel Kit	50	189.3 L	35.75" sq x 19.1" w	50.0 lb	90.8 cm sq x 48.5 cm	22.7 kg
FG9W5500 ^{PA}	DGRN, BRNZ	35-Gal Solid Square Panel Kit	35	189.3 L	29.13" sq x 19.75" w	40.0 lb	74 cm sq x 50.2 cm	18.1 kg
FG9W5600 ^{PA}	DGRN, BRNZ	50-Gal Solid Square Panel Kit	50	189.3 L	35.75" sq x 19.1" w	50.0 lb	90.8 cm sq x 48.5 cm	22.7 kg

STEP 3—RIGID LINERS (OPTIONAL)

No.	Color	Description	Capacity (Gal)	Capacity (Liters)	U.S. Dimensions	U.S. Ship Wt/Ctn	Metric Dimensions	Metric Ship Wt/Ctn
FG9W6300	BLA	35-Gal Rigid Liner	35	132.5 L	19.5" sq x 29" w	44.0 lb	49.5 cm sq x 73.7 cm	20 kg
FG9W6400	BLA	50-Gal Rigid Liner	50	189.3 L	19.5" sq x 36" w	52.0 lb	49.5 cm sq x 91.4 cm	23.6 kg

Round Containers

STEP 1—FRAME KITS – TOP AND BASE

No.	Color	Description	Capacity (Gal)	Capacity (Liters)	U.S. Dimensions	U.S. Ship Wt/Ctn	Metric Dimensions	Metric Ship Wt/Ctn
FG9W4300	BLA	Round Funnel Top Frame	32	121.13	23.5" dia x 35" h	50.5 lb	59.7 cm dia x 88.9 cm	22.9 kg
FG9W4400	BLA	Round Dome Top Frame	32	121.13	23.5" dia x 41" h	57.0 lb	59.7 cm dia x 104.1 cm	25.9 kg

STEP 2—PANEL KITS – PANELS AND POSTS

No.	Color	Description	Capacity (Gal)	Capacity (Liters)	U.S. Dimensions	U.S. Ship Wt/Ctn	Metric Dimensions	Metric Ship Wt/Ctn
FG9W5400 ^{PA}	SILV, DGRN, BRNZ	32-Gal Perforated Round Panel Kit	32	121.13	23.5" dia x 17" w	41.0 lb	59.7 cm dia x 43.2 cm	18.6 kg
FG9W5900 ^{PA}	DGRN, BRNZ	32-Gal Solid Round Panel Kit	32	121.13	23.5" dia x 17" w	41.0 lb	59.7 cm dia x 43.2 cm	18.6 kg

STEP 3—RIGID LINERS (OPTIONAL)

No.	Color	Description	Capacity (Gal)	Capacity (Liters)	U.S. Dimensions	U.S. Ship Wt/Ctn	Metric Dimensions	Metric Ship Wt/Ctn
FG9W6288 ⁹	BLA	32-Gal Round Liner	26	121.13	18.5" dia x 29" h	37.0 lb	47 cm dia x 73.7 cm	16.8 kg

Black (BLA), Dark Green (DGRN), Bronze (BRNZ), Silver (SILV)
⁹Panel Kit = 4 Panels, 4 Posts (Square); 3 Panels, 3 Posts (Round).
⁴Custom colors and imprinting available; contact Rubbermaid Customer Service.
⁹Pallet Pack = 4 ctn/pallet, 1 liner/ctn.



The Infinity™ Custom Design Program

TO LEARN MORE, CONTACT RUBBERMAID CUSTOMER SERVICE
 OR VISIT US ONLINE AT WWW.RUBBERMAIDINFINITY.COM.



1800 750 900



Classics

Perforated steel designs with a clean, modern appearance.

- Ideal for stadiums, municipalities, hotels, and schools
- Wide center band can be custom laser-cut to display your logo
- Fire-safe, heavy-gauge, hot-dipped galvanized powder-coated or stainless steel
- Adjustable leg levelers raise receptacle and provide stability on uneven surfaces
- Optional anchoring kits available
- No assembly required



Features cable-secured tops and can liner retainer bands.

ADDITIONAL FEATURES AND OPTIONS

Contact your Rubbermaid Commercial Products' Sales Representative for more information.



Optional ABS plastic lid for model S55.

FGABS55



FGOB55

Optional recessed base for model S55.



Optional Weather Shield for protection from the elements.



CLASSICS

Classics Recycling Options

Optional waste stream-specific decals convert Classics Containers to stylish recycling options for your facility. See decals on page 286.



CLASSICS RECYCLING OPTIONS

Shown with optional decals, sold separately (see page 286).

WHEN ORDERING PRODUCTS WITH **BOLD** COLOR CODES, PLEASE SPECIFY COLOR CODE AFTER THE PRODUCT NUMBER. SEE THE PRODUCT COLOR GUIDE AT THE BACK OF THE CATALOG.



This symbol, positioned with Decorative Receptacle refuse containers, indicates post-consumer recycled content (30% for steel, 70% for aluminum).

FGS55ET
Custom color
and laser-cut.



FGS55SST
Custom color and laser-cut.

FGS3ET
Custom color and laser-cut.

Classics Custom Options



Custom Colors

Available in a wide variety of custom colors to match your team or corporate color scheme.

Custom Graphics

Promote your team or corporate logo with long-lasting laser-cut graphics.

Contact your Rubbermaid Commercial Products' Sales Representative.

SAMPLE COLORS AND LINERS



Cobalt Blue
with Red Liner

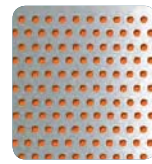

Silver Metallic
with Orange Liner



Red with
Black Liner

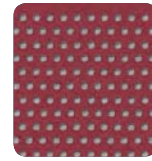

Crimson with
Gray Liner

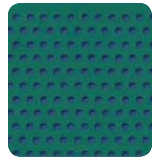

Empire Green
with Blue Liner

POWDER-COATED

No.	Color	Liner	Description	Capacity (gal)	Capacity (Liters)	U.S. Dimensions	U.S. Ship Wt/Ctn	Metric Dimensions	Metric Ship Wt/Ctn
FGS3ET	BK, HBZ, HGR	PL	Classics Drop Top w/ Levelers	25	94.6	18" dia x 35.5" h	49.0 lb	45.7 cm dia x 90.2 cm	22.2 kg
	SM	PL							
FGS55ET	BK	PL	Classics Drop Top w/ Levelers	51	193	24.5" dia x 35.5" h	73.0 lb	62.2 cm dia x 90.2 cm	33.1 kg
	SM	PL							

STAINLESS STEEL WITH BLACK OR STAINLESS STEEL LIDS

No.	Color	Liner	Description	Capacity (gal)	Capacity (Liters)	U.S. Dimensions	U.S. Ship Wt/Ctn	Metric Dimensions	Metric Ship Wt/Ctn
FGS55ETWS	BK	PL	Classics Drop Top w/ Levelers and Weather Shield	51	193	24.5" dia x 47" h	79.0 lb	62.2 cm dia x 119.4 cm	35.8 kg
FGS3SST	BK	PL	Classics Drop Top w/ Levelers	25	94.6	18" dia x 35.5" h	46.0 lb	45.7 cm dia x 90.2 cm	20.9 kg
	SS	PL							
FGS55SST	BK	PL	Classics Drop Top w/ Levelers	51	193	24.5" dia x 35.5" h	70.0 lb	62.2 cm dia x 90.2 cm	31.8 kg
	SS	PL							
FGS55SSTWS	BK	PL	Classics Drop Top w/ Levelers and Weather Shield	51	193	24.5" dia x 47" h	76.0 lb	62.2 cm dia x 119.4 cm	34.5 kg
FGOB55	BK	N/A	Classics Recessed Base Ring	N/A	N/A	21" dia x 2.5" h	7.0 lb	53.3 cm dia x 6.4 cm	3.2 kg

Black (BK), Hammertone Bronze (HBZ), Hammertone Charcoal (HGR), Silver Metallic (SM), Stainless Steel (SS) Plastic Liner (PL)
Custom colors and other custom options on pgs 286–291. Call Customer Service for pricing. For replacement liners, see page 204.

CLASSICS RECYCLING CONTAINERS

No.	Color	Liner	Description	Capacity (gal)	Capacity (Liters)	U.S. Dimensions	U.S. Ship Wt/Ctn	Metric Dimensions	Metric Ship Wt/Ctn
FGS3EG	BK	PL	Classics Recycle Receptacle	25	94.6	18" dia x 35.5" h	49.0 lb	45.7 cm dia x 90.2 cm	22.2 kg
FGS3EP	BK	PL	Classics Recycle Receptacle	25	94.6	18" dia x 35.5" h	49.0 lb	45.7 cm dia x 90.2 cm	22.2 kg
FGS3SSG	BK	PL	Classics Recycle Receptacle	25	94.6	18" dia x 35.5" h	46.0 lb	45.7 cm dia x 90.2 cm	20.9 kg
FGS3SSP	BK	PL	Classics Recycle Receptacle	25	94.6	18" dia x 35.5" h	46.0 lb	45.7 cm dia x 90.2 cm	20.9 kg

Black (BK), Hammertone Bronze (HBZ), Hammertone Charcoal (HGR), Silver Metallic (SM), Stainless Steel (SS) Plastic Liner (PL)
Custom colors and other custom options on pgs 286–291. Call Customer Service for pricing. For replacement liners, see page 204.

**Dimension
500 Series**

Contrasting-color perforated steel creates a layered dimension that complements contemporary environments.

- Heavy-gauge, hot-dipped galvanized fire-safe steel construction with durable Uni-Koat® powder-coat finish
- Weather urns neatly conceal smoker debris and shield contents from the elements
- FGR36, FGR38, and FGR48 models feature adjustable leg levelers for stability on uneven surfaces
- Anchoring kits and factory-installed lid locks available
- No assembly required

**Dimension
Standard Series**

Includes all of the features of the 500 Series in a sleek look and economical price.



No.	Color	Liner	Description	Capacity (gal)	Capacity (Liters)	U.S. Dimensions	U.S. Ship Wt/Ctn	Metric Dimensions	Metric Ship Wt/Ctn
FGR12	SBK	PL	Dimension Series Flat-Top	12	45.4	13.5" sq x 32" h	44 lb	34.3 cm sq x 81.3 cm	20 kg
FGR12SU	500	PL	Dimension Series Ash/Trash	12	45.4	13.5" sq x 32" h	47 lb	34.3 cm sq x 81.3 cm	21.3 kg
FGR12WU	SBK	PL	Dimension Series Ash/Trash w/ Weather Urn	12	45.4	13.5" sq x 35" h	50 lb	34.3 cm sq x 88.9 cm	22.7 kg
FGR18WU	500	PL	Dimension Series Ash/Trash w/ Weather Urn	12	45.4	13.5" sq x 35" h	50 lb	34.3 cm sq x 88.9 cm	22.7 kg
FGR36HT	SBK	PL	Dimension Series Hinged-Top	29	109.8	21" sq x 40" h	90 lb	53.3 cm sq x 101.6 cm	40.8 kg
FGR36HTWU	500	PL	Dimension Series Hinged-Top w/ Weather Urn	29	109.8	21" sq x 46" h	93 lb	53.3 cm sq x 116.8 cm	42.2 kg
FGR38HT	SBK	PL	Dimension Series Hinged-Top	29	109.8	21" sq x 46" h	93 lb	53.3 cm sq x 116.8 cm	42.2 kg
FGR38HTWU	500	PL	Dimension Series Hinged-Top w/ Weather Urn	29	109.8	21" sq x 46" h	93 lb	53.3 cm sq x 116.8 cm	42.2 kg
FGR40	SBK	N/A	Dimension Series Urn	N/A	N/A	10" sq x 24" h	28 lb	25.4 cm sq x 61 cm	12.7 kg
FGR40WU	SBK	N/A	Dimension Series Urn w/ Weather Shield	N/A	N/A	10" sq x 27" h	28 lb	25.4 cm sq x 68.6 cm	12.7 kg
FGR41	500	N/A	Dimension Series Ash/Trash	N/A	N/A	10" sq x 24" h	28 lb	25.4 cm sq x 61 cm	12.7 kg
FGR41WU	SBK	PL	Dimension Series Ash/Trash w/ Weather Shield	2.5	9.5	10" sq x 24" h	28 lb	25.4 cm sq x 61 cm	12.7 kg
FGR48HT	500	PL	Dimension Series Ash/Trash w/ Weather Shield	2.5	9.5	10" sq x 30" h	31 lb	25.4 cm sq x 76.2 cm	14.1 kg
FGR48HTWU	SBK	PL	Dimension Series Hinged-Top	48	181.7	26" sq x 40" h	130 lb	66 cm sq x 101.6 cm	59 kg
FGR48HTWU	500	PL	Dimension Series Hinged-Top w/ Weather Urn	48	181.7	26" sq x 46" h	130.0 lb	66 cm sq x 116.8 cm	59 kg

Black Solid Panels (SBK), Black w/ Anthracite Perforated Steel Panels (500) Plastic Liner (PL)
 Custom colors and other custom options on pgs 286–291. Call Customer Service for pricing. For replacement liners, see page 204.

**WHEN ORDERING PRODUCTS WITH BOLD COLOR CODES,
PLEASE SPECIFY COLOR CODE AFTER THE PRODUCT NUMBER.
SEE THE PRODUCT COLOR GUIDE AT THE BACK OF THE CATALOG.**

 This symbol, positioned with Decorative Receptacle refuse containers, indicates post-consumer recycled content (30% for steel, 70% for aluminum).

Leak-Proof Rigid Plastic Liner Included



Aspen Series

Designed to withstand heavy, constant use and endure severe weather conditions. Shipped fully assembled.

- Heavy-gauge, hot-dipped galvanized, fire-safe steel
- Weatherproof, Uni-Koat® powder-coated finish
- Leak-proof rigid plastic liners included
- Large capacity, one-piece top on all urn models
- FGR36, FGR38, and FGR48 models are equipped with adjustable leg levelers for stability on uneven surfaces
- Stone panels have a Class A fire rating
- Anchoring kits and factory-installed lid locks available
- Custom designs and logos available; contact your Rubbermaid Commercial Products' Representative



FGR122000



FGR126000



FGR12202



OPTIONAL WEATHER URNS CONCEAL SMOKERS' WASTE.

Custom designs and logos available; see pages 286-291.

No.	Color	Liner	Description	Capacity (gal)	Capacity (Liters)	U.S. Dimensions	U.S. Ship Wt/Ctn	Metric Dimensions	Metric Ship Wt/Ctn
FGR12	201, 202, 2000, 6000	PL	Aspen Flat-Top	12	45.4	13.5" sq x 32" h	44.0 lb	34.3 cm sq x 81.3 cm	20 kg
FGR12SU	201, 202, 2000, 6000	PL	Aspen Ash/Trash	12	45.4	13.5" sq x 32" h	47.0 lb	34.3 cm sq x 81.3 cm	21.3 kg
FGR12WU	201, 202, 2000, 6000	PL	Aspen Ash/Trash w/ Weather Urn	12	45.4	13.5" sq x 35" h	50.0 lb	34.3 cm sq x 88.9 cm	22.7 kg
FGR18	201	PL	Aspen Ash/Trash	24	90.8	18" sq x 32" h	66.0 lb	45.7 cm x 81.3 cm	29.9 kg
FGR18SU	201, 202, 2000, 6000	PL	Aspen Ash/Trash	24	90.8	18" sq x 32" h	66.0 lb	45.7 cm sq x 81.3 cm	29.9 kg
FGR18WU	201, 202, 2000, 6000	PL	Aspen Ash/Trash w/ Weather Urn	24	90.8	18" sq x 38" h	77.0 lb	45.7 cm sq x 96.5 cm	34.9 kg
FGR36HT	201, 202, 2000, 6000	PL	Aspen Hinged-Top	29	109.8	21" sq x 40" h	90.0 lb	53.3 cm sq x 101.6 cm	40.8 kg
FGR36HTWU	201, 202, 2000, 6000	PL	Aspen Hinged-Top w/ Weather Urn	29	109.8	21" sq x 46" h	93.0 lb	53.3 cm sq x 116.8 cm	42.2 kg
FGR38HT	201, 202, 2000, 6000	PL	Aspen Hinged-Top	38	143.8	26" sq x 40" h	125.0 lb	66 cm sq x 101.6 cm	56.7 kg
FGR38SD	201	PL	Aspen Side Door w/ Cam Lock	38	143.8	26" sq x 40" h	133.0 lb	66 cm sq x 101.6 cm	60.3 kg
FGR38HTWU	201, 202, 2000, 6000	PL	Aspen Hinged-Top w/ Weather Urn	38	143.8	26" sq x 46" h	128.0 lb	66 cm sq x 116.8 cm	58.1 kg
FGR40	201, 202, 2000, 6000	N/A	Aspen Urn	N/A	N/A	10" sq x 24" h	28.0 lb	25.4 cm sq x 61 cm	12.7 kg
FGR40WU	201, 202, 2000, 6000	N/A	Aspen Urn w/ Weather Shield	N/A	N/A	10" sq x 27" h	28.0 lb	25.4 cm sq x 68.6 cm	12.7 kg
FGR41	201, 202, 2000, 6000	PL	Aspen Ash/Trash	2.5	9.5	10" sq x 24" h	28.0 lb	25.4 cm sq x 61 cm	12.7 kg
FGR41WU	201, 202, 2000, 6000	PL	Aspen Ash/Trash w/ Weather Shield	2.5	9.5	10" sq x 30" h	31.0 lb	25.4 cm sq x 76.2 cm	14.1 kg
FGR48HT	201, 202, 2000, 6000	PL	Aspen Hinged-Top	48	181.7	26" sq x 40" h	130.0 lb	66 cm sq x 101.6 cm	59 kg
FGR48HTWU	201, 202, 2000, 6000	PL	Aspen Hinged-Top w/ Weather Urn	48	181.7	26" sq x 46" h	130.0 lb	66 cm sq x 116.8 cm	59 kg

Brown w/ Desert Brown Stone Panels (201), Empire Green w/ Desert Brown Stone Panels (202), Gray w/ Dove Gray Stone Panels (2000), Architectural Bronze w/ Glacier Gray Stone Panels (6000) Plastic Liner (PL)

Custom colors and other custom options on pgs 286-291. Call Customer Service for pricing. For replacement liners, see page 204.

Landmark Series® Classic Containers

High-volume refuse collection and smoking management for indoor and outdoor areas, including building entrances, lobbies, and malls.

- Choose Dome Top model for outdoor use or Funnel Top model for indoor use
- Tops are hinged and include a stay-open strap for easy access to rigid liner
- Ash/Trash models include metal sand pan and large refuse openings
- Locking Dome Top model (FG397088) provides added security



ADA COMPLIANT



2-STEP ORDERING PROCESS

STEP 1: CHOOSE FRAME SIZE AND STYLE		STEP 2: CHOOSE PANELS (4 PANELS PER UNIT)	
 FUNNEL TOP ASH/TRASH CONTAINER Available in 20 Gal and 35 Gal	 FUNNEL TOP Available in 20 Gal and 35 Gal	 FG400200 Fits 20-Gal Landmark Series® Containers Coral CORL, River Rock ROCK	 FG400300 Fits 35-Gal Landmark Series® Containers Brown Stone BSTON, Coral CORL, River Rock ROCK
 DOME TOP ASH/TRASH CONTAINER Available in 35 Gal and 50 Gal	 DOME TOP Available in 35 Gal and 50 Gal	 FG400400 Fits 50-Gal Landmark Series® Containers Brown Stone BSTON, Coral CORL, River Rock ROCK	 FG400500 Fits 50-Gal Landmark Series® Containers Clear CLR

No.	Color	Description (w/o Panels)	Capacity (Gal)	Capacity (Liters)	U.S. Dimensions	U.S. Ship Wt/Ctn	Metric Dimensions	Metric Ship Wt/Ctn
FG396600	SBLE, DWOOD	Landmark Series® Classic Container, Ash/Trash Frame with FG356900 Rigid Liner	20	75.7	21" sq x 30.5" h	32.8 lb	53.3 cm sq x 77.5 cm	14.9 kg
FG396700	SBLE	Landmark Series® Classic Container, Funnel Top Frame with FG356900 Rigid Liner	20	75.7	21" sq x 30.5" h	33.6 lb	53.3 cm sq x 77.5 cm	15.2 kg
FG397000	SBLE, DWOOD, BLA	Landmark Series® Classic Container, Dome Top Frame with FG395800 Rigid Liner	35	132.5	26" sq x 40" h	49.6 lb	66 cm sq x 101.6 cm	22.5 kg
FG397001	SBLE, DWOOD, BLA	Landmark Series® Classic Container, Dome Top with Ashtray, Frame and FG395800 Rigid Liner	35	132.5	26" sq x 40" h	51.6 lb	66 cm sq x 101.6 cm	23.4 kg
FG397088	BLA	Landmark Series® Classic Container, Dome Top Frame with Lock Option, with FG395800 Rigid Liner	35	132.5	26" sq x 40" h	48.9 lb	66 cm sq x 101.6 cm	22.2 kg
FG397100	SBLE, DWOOD	Landmark Series® Classic Container, Ash/Trash Frame with FG395800 Rigid Liner	35	132.5	26" sq x 30.5" h	43.4 lb	66 cm sq x 77.5 cm	19.7 kg
FG397200	SBLE	Landmark Series® Classic Container, Funnel Top Frame with FG395800 Rigid Liner	35	132.5	26" sq x 30.5" h	43.0 lb	66 cm sq x 77.5 cm	19.5 kg
FG397500	SBLE, DWOOD, BLA	Landmark Series® Classic Container, Dome Top Frame with FG395900 Rigid Liner	50	189.3	26" sq x 46.5" h	55.5 lb	66 cm sq x 118.1 cm	25.2 kg
FG397501	SBLE, DWOOD, BLA	Landmark Series® Classic Container, Dome Top with Ashtray, Frame and FG395900 Rigid Liner	50	189.3	26" sq x 46.5" h	58.2 lb	66 cm sq x 118.1 cm	26.4 kg

LANDMARK SERIES® CLASSIC PANELS (SOLD SEPARATELY)

No.	Color	Description	U.S. Dimensions	U.S. Ship Wt/Ctn	Metric Dimensions	Metric Ship Wt/Ctn
FG400200	ROCK, CORL	Aggregate Panel for FG396600, FG396700 Landmark Series® Classic Containers	27.9" l x 15.7" w x 0.38" h	34.9 lb	70.9 cm x 39.9 cm x 1 cm	15.8 kg
FG400300	ROCK, CORL, BSTON	Aggregate Panel for FG397000, FG397001, FG397088, FG397100, FG397200 Landmark Series® Classic Containers	27.9" l x 15.7" w x 0.38" h	38.7 lb	70.9 cm x 39.9 cm x 1 cm	17.6 kg
FG400400	ROCK, CORL, BSTON	Aggregate Panel for FG397500, FG397501 Landmark Series® Classic Containers	34.3" l x 20.7" w x 0.38" h	49.0 lb	87.1 cm x 52.6 cm x 1 cm	22.2 kg
FG400500	CLR	Panels with Backing for Advertising for FG397500, FG397501 Containers	34.3" l x 20.7" w x 0.38" h	22.0 lb	87.1 cm x 52.6 cm x 1 cm	10 kg

Black (BLA), Brown Stone (BSTON), Clear (CLR), Coral (CORL), Driftwood (DWOOD), River Rock (ROCK), Sable (SBLE)

WHEN ORDERING PRODUCTS WITH **BOLD** COLOR CODES, PLEASE SPECIFY COLOR CODE AFTER THE PRODUCT NUMBER. SEE THE PRODUCT COLOR GUIDE AT THE BACK OF THE CATALOG.

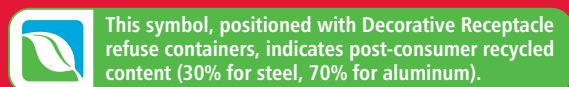

MOUNTING OPTIONS

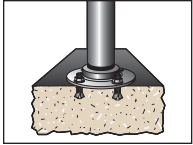
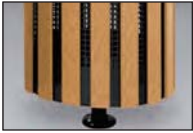

Surface-Mount Pole (FGHPSM)

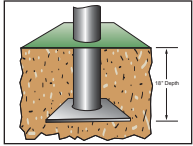

In-Ground Pole (FGHPIG)



FGH12SMC /
FG2030 Top

FGH55C /
FG1855 Top

Shown with optional tops. Call your Rubbermaid Commercial Products' Sales Representative for ordering information.

PLASTIC LUMBER SLATS



FGH55EGN

FGH3BK

FGH9NEGN
Shown with optional
customization.
See pgs 286-287
for options.

FGHPSM (Pole)

FGH1NBK

PERFORATED STEEL



FGH9NBK



Optional funnel top.



Optional bracket kit permits easy removal; security key lock prevents theft.

Towne Series

- Models FGH125C and FGH55C feature durable and attractive slats made from **100% post-consumer recycled polyethylene**
- Heavy-gauge, galvanized fire-safe steel
- See-through design for added security
- Retainer bands hold can liners securely out of sight
- Bottom drain holes help prevent water accumulation
- All pole/wall-mount models include strapping kits for poles up to 12" in diameter
- Optional plastic liners, accessories, and decals available; contact your Rubbermaid Commercial Products' Sales Representative
- Lids sold separately



The round perforated-steel design has all the features listed above and provides a clean, modern appearance.

No.	Color	Description	Capacity (gal)	Capacity (Liters)	U.S. Dimensions	U.S. Ship Wt/Ctn	Metric Dimensions	Metric Ship Wt/Ctn
FGFTH1	BK	Towne Series Funnel Top for use w/ FGH1N	N/A	N/A	12" dia	3.5 lb	30.5 cm dia	1.6 kg
FGFTH3	BK	Towne Series Funnel Top for use w/ FGH3	N/A	N/A	18" dia	6.5 lb	45.7 cm dia	2.9 kg
FGFTH9	BK	Towne Series Funnel Top for use w/ FGH9N	N/A	N/A	15" dia	5.0 lb	38.1 cm dia	2.3 kg
FGH12IG	C	Towne Series Post-Mount w/ Ground Post	34	128.7	18" dia x 35" h	61.0 lb	45.7 cm dia x 88.9 cm	27.7 kg
FGH12SM	C	Towne Series Post-Mount w/ Surface Post	34	128.7	18" dia x 35" h	60.0 lb	45.7 cm dia x 88.9 cm	27.2 kg
FGH1N	BK, EGN	Towne Series Pole/Wall Mount	10	37.9	12" dia x 24" h	15.0 lb	30.5 cm dia x 61 cm	6.8 kg
FGH1NLIDKIT	BK, EGN	Towne Series Lid Kit	N/A	N/A	N/A	N/A	N/A	N/A
FGH3	BK, EGN	Towne Series Free-Standing w/ Security Chain Holes	34	128.7	18" dia x 35" h	31.0 lb	45.7 cm dia x 88.9 cm	14.1 kg
FGH55	C	Towne Series Free-Standing	63	238.5	23" dia x 36" h	70.0 lb	58.4 cm dia x 91.4 cm	31.8 kg
FGH55E	BK, EGN	Towne Series Free-Standing	63	238.5	23" dia x 36" h	51.0 lb	58.4 cm dia x 91.4 cm	23.1 kg
FGH9N	BK, EGN	Towne Series Pole/Wall Mount	22	83.3	15" dia x 30" h	21.0 lb	38.1 cm dia x 76.2 cm	9.5 kg
FGHBRKTKIT	BK	Towne Series Mounting Bracket for FGH1N, FGH9N	N/A	N/A	N/A	4.0 lb	N/A	1.8 kg
FGHPSM		Towne Series Surface-Mount Pole w/ Hardware	N/A	N/A	2" dia x 46" h	13.0 lb	5.1 cm dia x 116.8 cm	5.9 kg
FGHPIG		Towne Series In-Ground Pole w/ Hardware	N/A	N/A	2" dia x 64" h	16.0 lb	5.1 cm dia x 162.6 cm	7.3 kg

Black (BK), Cedar (C), Empire Green (EGN)

Custom options on pgs 286-291. Call Customer Service for pricing. For replacement liners, see page 204.

Regent 50 Series

- Plastic lumber slats are made from **100% post-consumer recycled polyethylene**
- Heavy-gauge, galvanized fire-safe steel
- Indoor or outdoor use
- No assembly required



Cable-secured top on models FGR23SU50 and FGR56SU50.



No.	Liner	Color	Description	Capacity (gal)	Capacity (Liters)	U.S. Dimensions	U.S. Ship Wt/Ctn	Metric Dimensions	Metric Ship Wt/Ctn
FGR1450	PL	EGN	Regent 50 Series Flat-Top	12	45.4	13.5" sq x 32" h	44.0 lb	34.3 cm sq x 81.3 cm	20 kg
FGR14SU50	PL	EGN	Regent 50 Series Ash/Trash	12	45.4	13.5" sq x 32" h	40.0 lb	34.3 cm sq x 81.3 cm	18.1 kg
FGR14WU50	PL	EGN	Regent 50 Series Ash/Trash w/ Weather Urn	12	45.4	13.5" sq x 35" h	47.0 lb	34.3 cm sq x 88.9 cm	21.3 kg
FGR2350	PL	EGN	Regent 50 Series Flat-Top	12	45.4	16" dia x 31" h	41.0 lb	40.6 cm dia x 78.7 cm	18.6 kg
FGR23SU50	PL	EGN	Regent 50 Series Ash/Trash	12	45.4	16" dia x 31" h	41.0 lb	40.6 cm dia x 78.7 cm	18.6 kg
FGR25T50	PL	EGN	Regent 50 Series Round-Top	15	56.8	16" dia x 35.5" h	37.0 lb	40.6 cm dia x 90.2 cm	16.8 kg
	RB	EGN		22	83.3				
FGR34HT50	PL	EGN	Regent 50 Series Hinged-Top	29	109.8	21" sq x 37" h	83.0 lb	53.3 cm sq x 94 cm	37.6 kg
FGR34HTWU50	PL	EGN	Regent 50 Series Hinged-Top w/ Weather Urn	29	109.8	21" sq x 40" h	86.0 lb	53.3 cm sq x 101.6 cm	39 kg
FGR5650	PL	EGN	Regent 50 Series Flat-Top	40	151.4	24.5" dia x 36" h	77.0 lb	62.2 cm dia x 91.4 cm	34.9 kg
FGR56SU50	PL	EGN	Regent 50 Series Ash/Trash	40	151.4	24.5" dia x 36" h	82.0 lb	62.2 cm dia x 91.4 cm	37.2 kg

WHEN ORDERING PRODUCTS WITH **BOLD** COLOR CODES, PLEASE SPECIFY COLOR CODE AFTER THE PRODUCT NUMBER. SEE THE PRODUCT COLOR GUIDE AT THE BACK OF THE CATALOG.



This symbol, positioned with Decorative Receptacle refuse containers, indicates post-consumer recycled content (30% for steel, 70% for aluminum).

Keystone Series™

Extremely durable steel and precast concrete construction endures constant use and harsh weather conditions.

- Tops are heavy-gauge, hot-dipped galvanized, powder-coated, fire-safe steel
- Leak-proof rigid plastic liners included
- Light sandblast finish
- Precast Portland cement (ASTM C150 type 1 or 3) treated with water-repellent sealer
- Air entrainment 4%–6% to prevent cracking
- Reinforcing steel conforms to ASTM 615 and deformations conform to ASTM-M-305
- Custom advertising panels available; contact your Rubbermaid Commercial Products Sales Representative
- No assembly required



ADA COMPLIANT



Easy-to-empty Hinged-Top on FGKSR36 and FGKSR36WU



Cable-secured top on models FGKSM32



Custom advertising panels available.



FGB25 / FGS25

No.	Color	Liner	Description (w/o Panels)	Capacity (Gal)	Capacity (Liters)	U.S. Dimensions	U.S. Ship Wt/Ctn	Metric Dimensions	Metric Ship Wt/Ctn
FGKSB	7000, 8000	N/A	Keystone Series™ Bench	N/A	N/A	72" l x 18" w x 21" h	420.0 lb	182.9 cm x 45.7 cm x 53.3 cm	190.5 kg
FGKSM10	7000, 8000	N/A	Keystone Series™ Urn	N/A	N/A	20" dia x 23" h	215.0 lb	50.8 cm dia x 58.4 cm	97.5 kg
FGKSM32	7000, 8000	PL	Keystone Series™ Open-Top	21	79.5	32" dia x 33" h	640.0 lb	81.3 cm dia x 83.8 cm	290.3 kg
FGKSR12SU	7000, 8000	PL	Keystone Series™ Ash/Trash	12	45.4	16" sq x 32.5" h	260.0 lb	40.6 cm sq x 82.6 cm	117.9 kg
FGKSR36	7000, 8000	PL	Keystone Series™ Hinged-Top Receptacle	29	109.8	22.5" sq	N/A	57.2 cm sq	N/A
FGKSR36WU	7000, 8000	PL	Keystone Series™ Hinged-Top w/ Weather Urn	29	109.8	22.5" sq	N/A	57.2 cm sq	N/A
FGKSR48SD	7000, 8000	PL	Keystone Series™ Front Door	48	181.7	26" sq x 42" h	725.0 lb	66 cm sq x 106.7 cm	328.9 kg
FGKSR48SDWU	7000, 8000	PL	Keystone Series™ Front Door w/ Weather Urn	48	181.7	26" sq	N/A	66 cm sq	N/A

Gray w/ Silverstone Gray Concrete (7000), Architectural Bronze w/ Sierra Brown Concrete (8000), Plastic Liner (PL)
All Keystone Concrete items are Made to Order (MTO) and are non-returnable.

SAND

No.	Color	Description	Capacity (Gal)	Capacity (Liters)	U.S. Dimensions	U.S. Ship Wt/Ctn	Metric Dimensions	Metric Ship Wt/Ctn
FGB25	Black	Sand (5 x 5 lbs)	N/A	N/A	N/A	27.0 lb	N/A	12.2 kg
FGS25	White	White Silica Sand	N/A	N/A	N/A	27.0 lb	N/A	12.2 kg

Ranger®

Ranger® waste containers feature Rubbermaid's famous durability, modern styling, and easy-to-service design.

- High-capacity waste management: 65-Gallon Ranger® is the largest waste container in Rubbermaid's line
- Designed for stadiums, parks, shopping malls, and other high-traffic areas
- Permanently attached hinged lid for easy emptying
- Pedestal base ring on 45-gallon and 65-gallon containers for stability and security (to be filled with sand or water by customer)



ADA COMPLIANT



FG917600

FG917188

FG843088



BETTER LINER RETENTION

Metal retainers keep can liners securely in place and eliminate knot tying.



WEIGHTED BASE OPTION

Optional Weighted Base (FG917700) is secured with screws and is available for 45- and 65-Gallon Ranger® containers for added stability. To be filled with sand or water by customer.

LID OPTIONS

Ranger® 45- and 65-Gallon Containers are available in two styles:

2 HINGED DOORS for waste concealment and odor control.

4 OPENINGS for easier access in high-traffic areas.



ENHANCED DURABILITY

Ranger® lids feature integrated, durable hinges that keep the lid securely attached to the container during emptying.



FG917500

No.	Color	Description	Capacity (Gal)	Capacity (Liters)	U.S. Dimensions	U.S. Ship Wt/Ctn	Metric Dimensions	Metric Ship Wt/Ctn
FG843088 ¹	BRN, BLA, BEIG	35-Gallon Ranger® Container	35	132.5	21.5" sq x 41" h	30.4 lb	54.6 cm sq x 104.1 cm	13.8 kg
FG917188 ¹	BLA, BEIG	45-Gallon Ranger® Container with 2 Doors	45	170.3	24.88" sq x 41.5" h	42.5 lb	63.2 cm sq x 105.4 cm	19.3 kg
FG917388 ^a	BLA, BEIG	45-Gallon Ranger® Container with 4 Openings	45	170.3	24.88" sq x 41.5" h	37.9 lb	63.2 cm sq x 105.4 cm	17.2 kg
FG917500 ¹	BLA, BEIG	65-Gallon Ranger® Container with 2 Doors	65	246.1	24.88" sq x 49.25" h	51.1 lb	63.2 cm sq x 125.1 cm	23.2 kg
FG917600 ^a	BLA, BEIG	65-Gallon Ranger® Container with 4 Openings	65	246.1	24.88" sq x 49.25" h	46.5 lb	63.2 cm sq x 125.1 cm	21.1 kg
FG917700 ¹	BLA, BEIG	Weighted Base Accessory for 45- and 65-Gallon Ranger® Containers	N/A	N/A	24.5" sq x 6" h	8.5 lb	62.2 cm sq x 15.2 cm	3.9 kg
FG395800	GRAY, BEIG	Untouchable® Square Container (liner for FG917188/FG917388)	35	132.5	19.5" sq x 27.63" h	39.4 lb	49.5 cm sq x 70.2 cm	17.9 kg
FG395900	GRAY, BEIG	Untouchable® Square Container (liner for FG917500/FG917600)	50	189.3	19.5" sq x 34.25" h	53.9 lb	49.5 cm sq x 87 cm	24.4 kg
FG356600	GRAY	Rigid Liner for FG843088	24.5	93.4 L	16.25" sq x 28.5" h	33.3 lb	41.3 cm sq x 72.4 cm	15.1 kg

Beige (BEIG), Black (BLA), Brown (BRN), Gray (GRAY) ^a Provides hands-free use.

¹FM-Approved

WHEN ORDERING PRODUCTS WITH **BOLD** COLOR CODES, PLEASE SPECIFY COLOR CODE AFTER THE PRODUCT NUMBER. SEE THE PRODUCT COLOR GUIDE AT THE BACK OF THE CATALOG.



Check out the items marked with this symbol for our new line of Executive Series™ products.



FG9P9000*
The 35-gallon size is ideal for tight spaces.



FG396500*



Plaza®

Contemporary styling with side opening door for "no lift" unloading.

- The 35-gallon size is ideal for tight spaces and ships fully assembled
- Spring-loaded swing doors help contain odors
- Includes bolt-down capability
- Textured top model accommodates up to 15" x 20" (38.1 cm x 50.8 cm) trays
- Models FG396300, FG396400, and FG9P9000 are Factory Mutual (FM) and approved when used with FG395800 and FG356300 Rigid Liners, respectively



ADA COMPLIANT



APPROVED 6921



Rigid Liner Sold Separately

FG396500* and FG9P9100* include a convenient ashtray insert.



FG256B00* / FG256V00 / FG256W00

FG256X00 / FG256B00



FG256V00

Glutton®

Large-capacity containers for indoor/outdoor use.

- Perfect for large crowds and high-traffic areas
- Withstands extreme weather and handling
- Hooded top available with and without doors
- Hold-down base can be filled with sand or water to provide added stability and security



ADA COMPLIANT



PLAZA®

No.	Color	Description	Capacity (Gal)	Capacity (Liters)	U.S. Dimensions	U.S. Ship Wt/Ctn	Metric Dimensions	Metric Ship Wt/Ctn
FG396300 [†]	BLA, BEIG	Plaza® Container with Tray Top	50	189.3	24.75" l x 25.25" w x 43" h	81.0 lb	62.9 cm x 64.1 cm x 109.2 cm	36.7 kg
FG396400 [†]	DGRN, BLA, BEIG	Plaza® Container	50	189.3	24.75" l x 25.25" w x 42.13" h	78.0 lb	62.9 cm x 64.1 cm x 107 cm	35.4 kg
FG396500*	DGRN, BLA, BEIG	Plaza® Container with Ashtray	50	189.3	24.75" l x 25.25" w x 42.13" h	78.0 lb	62.9 cm x 64.1 cm x 107 cm	35.4 kg
FG9P9000 [†]	DGRN, BLA, BEIG	Plaza® Jr. Container	35	132.5	21.4" l x 20.3" w x 41.1" h	51.8 lb	54.4 cm x 51.6 cm x 104.4 cm	23.5 kg
FG9P9100*	DGRN, BLA, BEIG	Plaza® Jr. Container with Ashtray Top	35	132.5	21.4" l x 20.3" w x 41.1" h	53.6 lb	54.4 cm x 51.6 cm x 104.4 cm	24.3 kg
FG356300	BEIG	Rigid Liner for FG9P9000 and FG9P9100 Containers	19	71.9	14.2" sq x 28" h	27.0 lb	36.1 cm sq x 71.1 cm	12.2 kg
FG395800 [†]	GRAY, BEIG	Untouchable® Square Container (liner for FG396500)	50	132.5	19.5" sq x 27.63" h	39.4 lb	49.5 cm sq x 70.2 cm	17.9 kg

Beige (BEIG), Black (BLA), Dark Green (DGRN), Gray (GRAY)

*Custom imprinting available; contact Rubbermaid Customer Service at (800) 347-9800. †Does not include rigid liner. † FM-Approved

GLUTTON®

No.	Color	Description	Capacity (Gal)	Capacity (Liters)	U.S. Dimensions	U.S. Ship Wt/Ctn	Metric Dimensions	Metric Ship Wt/Ctn
FG256B00*	OWHT, BRN	Glutton® Container	56	212	25.5" l x 22.75" w x 31.13" h	67.3 lb	64.8 cm x 57.8 cm x 79.1 cm	30.5 kg
FG256V00	RED, BRN	Glutton® Hooded Top without doors for FG256B00 Containers	N/A	N/A	26.63" l x 23" w x 13" h	14.2 lb	67.6 cm x 58.4 cm x 33 cm	6.4 kg
FG256W00	BLA	Hold Down Base for FG256B00 Containers	N/A	N/A	21.13" l x 18" w x 5" h	6.4 lb	53.7 cm x 45.7 cm x 12.7 cm	2.9 kg
FG256X00	RED, BRN	Glutton® Hooded Top with doors for FG256B00 Containers	N/A	N/A	26.63" l x 23" w x 13" h	19.2 lb	67.6 cm x 58.4 cm x 33 cm	8.7 kg
FG256K00	GRAY	Rigid Liner for Glutton® Container	42 gal	159 L	23.25" l x 20.25" w x 29" h	48.1 lb	59.1 cm x 51.4 cm x 73.7 cm	21.8 kg

Black (BLA), Brown (BRN), Off White (OWHT), Red (RED)

*Custom imprinting available; contact Rubbermaid Customer Service at (800) 347-9800.

Landmark Series® Security Container

The solution for secure, effective, and affordable waste management.

- Complies with Department of Homeland Security Directive SD RAILPAX-04-01
- Provides total visibility of contents for improved security
- Constructed of durable, chemical-resistant, engineered polymer for easy cleaning and long life
- Locking dome top and bolt-down capability for added security
- Can liner retainer band for easy servicing
- No assembly required



ADA COMPLIANT

FG397589 and FG400700 are ideal for security-conscious facilities such as airports, train stations, sports facilities, government and office complexes, and convention centers.



FG397589 / FG400700

Polyliner retainer band for easy servicing.



Quick bag attachment and removal.



Panels are replaceable for extended life.



Street Baskets

Designed to withstand constant use and harsh weather conditions. See-through design is ideal for city streets, parks, beaches, and other high-traffic areas.

- All-weather corrosion-resistant material
- Easy to transport and store
- Drain holes allow rain run-off
- Anchoring kits available to prevent tipping or theft



ADA COMPLIANT



FGSBR52GRN

FGSBR52GALV

FGSBR52BK

FGSBR52COB

FGSBR52RD

Shown with optional drum top FG1855BK.

WHEN ORDERING PRODUCTS WITH **BOLD** COLOR CODES, PLEASE SPECIFY COLOR CODE AFTER THE PRODUCT NUMBER. SEE THE PRODUCT COLOR GUIDE AT THE BACK OF THE CATALOG.



This symbol, positioned with Decorative Receptacle refuse containers, indicates post-consumer recycled content (30% for steel, 70% for aluminum).



FG397500 / FG400500



FGSM1



FGSM7

Landmark Series® Classic Containers

CLEAR PANEL OPTION

- Generate revenue by selling advertising space or promoting products on your containers
- High-impact acrylic panels supported by rigid poly backing for durability and weather resistance
- Tamper-resistant frame discourages vandalism of advertising materials



Street Media Series

Turn trash into cash by selling advertising space to generate revenue.

- Prominently display advertisers' brands and messages in vinyl decals (FGSM7) or easy-to-change message panels (FGSM1) (sold separately)
- Advertisers can target and reach countless defined customers in high-traffic areas or temporary locations during special events



LANDMARK SERIES® SECURITY CONTAINER

No.	Color	Description	Capacity (gal)	Capacity (Liters)	U.S. Dimensions	U.S. Ship Wt/Ctn	Metric Dimensions	Metric Ship Wt/Ctn
FG397589	BLA	Landmark Series® Security Container with Lock and Clear Panels	50	189.3	26" sq x 46.5" h	62.4 lb	66 cm sq x 118.1 cm	28.3 kg
FG400600	CLR	Clear Replacement Panel for FG397000, FG397001, FG397088, FG397100, FG397200 Containers	N/A	N/A	20.5" l x 27.9" w x 2.75" h	14.8 lb	52.1 cm x 70.9 cm x 7 cm	6.7 kg
FG400700	CLR	Clear Replacement Panel for FG397500, FG397501, FG397589 Containers	N/A	N/A	20.5" l x 34" w x 2.75" h	17.7 lb	52.1 cm x 86.4 cm x 7 cm	8 kg

Black (BLA), Clear (CLR)

STREET BASKETS

No.	Color	Description	Capacity (gal)	Capacity (Liters)	U.S. Dimensions	U.S. Ship Wt/Ctn	Metric Dimensions	Metric Ship Wt/Ctn
FGSBR52	GALV, BK, COB, GRN, RD	Street Basket	45	170.3	24" dia x 33" h	41.0 lb	61 cm dia x 83.8 cm	18.6 kg

Black (BK), Cobalt Blue (COB), Galvanized (GALV), Moss Green (GRN), Red (RD)

LANDMARK SERIES® CLASSIC CONTAINERS (WITHOUT PANELS)

No.	Color	Description	Capacity (Gal)	Capacity (Liters)	U.S. Dimensions	U.S. Ship Wt/Ctn	Metric Dimensions	Metric Ship Wt/Ctn
FG397500	SBLE, DWOOD, BLA	Landmark Series® Classic Container, Dome Top Frame with FG395900 Rigid Liner	50	189.3	26" sq x 46.5" h	55.5 lb	66 cm sq x 118.1 cm	25.2 kg
FG397501	SBLE, DWOOD, BLA	Landmark Series® Classic Container, Dome Top with Ashtray, Frame and FG395900 Rigid Liner	50	189.3	26" sq x 46.5" h	58.2 lb	66 cm sq x 118.1 cm	26.4 kg

Black (BLA), Driftwood (DWOOD), Sable (SBLE)

LANDMARK SERIES® CLASSIC PANELS (SOLD SEPARATELY)

No.	Color	Description	U.S. Dimensions	U.S. Ship Wt/Ctn	Metric Dimensions	Metric Ship Wt/Ctn
FG400500	CLR	Panels with Backing for Advertising for FG397500, FG397501 Containers	34.3" l x 20.7" w x 0.38" h	22.0 lb	87.1 cm x 52.6 cm x 1 cm	10 kg

Clear (CLR)

STREET MEDIA SERIES

No.	Color	Description	Capacity (Gal)	Capacity (Liters)	U.S. Dimensions	U.S. Ship Wt/Ctn	Metric Dimensions	Metric Ship Wt/Ctn
FGSM1*	BLA	Street Media 2 Panel, Perforated Sides	51	193	25" dia x 35.5" h	70 lb	63.5 cm dia x 90.2 cm	31.8 kg
FGSM7*	BLA	Street Media Complete Graphic Wrap	25	94.6	18" dia x 35.5" h	45 lb	45.7 cm dia x 90.2 cm	20.4 kg

*Call your Rubbermaid Commercial Products Sales Representative for more information.

Landmark Series® Gas Station/Store Front Containers

Style combined with functionality helps make gas islands and store fronts appealing and efficient.

- Landmark Series® models integrate waste management and window washing
- Insert personal messages and advertising with panel frame models (FG9W0200, FG9W0300)
- Landmark Series® models include rigid liner (FG395800)
- Standard bolt-down base for stability
- FG9W1400 provides an affordable funnel-top container for stadiums, retail, education, and hospitality environments
- FG9W1300 lid also fits 32-gal BRUTE® containers (FG263200)



Display your own custom insert to promote special messages right at the pump.



FG9W0200 / FG9W0400 / FG9W0500



ADA COMPLIANT

PANEL COLORS FOR FG9W0500 (SOLD SEPARATELY).



Sterling Gray



Charcoal Marble



FG9W1400



FG9W0300

FG9W0200

No.	Color	Description (w/o Panels)	Capacity (Gal)	Capacity (Liters)	U.S. Dimensions	U.S. Ship Wt/Ctn	Metric Dimensions	Metric Ship Wt/Ctn
FG9W0000	BLA	Landmark Series® Standard Funnel Top	35	132.5	24" sq x 31" h	28.2 lb	61 cm sq x 78.7 cm	12.8 kg
FG9W0100	BLA	Landmark Series® Standard Dome Top	35	132.5	24" sq x 43" h	31.0 lb	61 cm sq x 109.2 cm	14.1 kg
FG9W0200	BLA	Landmark Series® Funnel Top with Panel Frame and FG395800 Rigid Liner	35	132.5	24" sq x 31" h	30.2 lb	61 cm sq x 78.7 cm	13.7 kg
FG9W0300	BLA	Landmark Series® Dome Top with Panel Frame and FG395800 Rigid Liner	35	132.5	24" sq x 43" h	33.0 lb	61 cm sq x 109.2 cm	15 kg
FG9W1200	BLA	Light Duty Container Base	32	121.1	22" dia x 28" h	45.5 lb	55.9 cm dia x 71.1 cm	20.6 kg
FG9W1300	GRAY, BLA	Light Duty Container Lid for FG9W1200, FG263200 Containers	N/A	N/A	22.25" dia x 2.75" h	10.9 lb	56.5 cm dia x 7 cm	4.9 kg
FG9W1400	BLA	Light Duty Container Combo, Contains (1) FG9W1200 and (1) FG9W1300	32	121.1	22.25" dia x 29.5" h	37.7 lb	56.5 cm dia x 74.9 cm	17.1 kg

Black (BLA), Gray (GRAY)

LANDMARK SERIES® PANELS AND ACCESSORIES (SOLD SEPARATELY)

No.	Color	Description	Capacity (Gal)	Capacity (Liters)	U.S. Dimensions	U.S. Ship Wt/Ctn	Metric Dimensions	Metric Ship Wt/Ctn
FG9W0400	BLA	Window Wash Kit for FG9W0000, FG9W0100, FG9W0200, FG9W0300 Containers	N/A	N/A	6.25" l x 16.25" w x 30" h	8.2 lb	15.9 cm x 41.3 cm x 76.2 cm	3.7 kg
FG9W0500*	CMARB, SGRAY	Decorative Panels for FG9W0200, FG9W0300 Containers	N/A	N/A	20" l x 12" w x 0.1" h	2.9 lb	50.8 cm x 30.5 cm x 0.3 cm	1.3 kg
FG9W0600	BLA	Pole/Wall-Mount Kit for Window Wash Unit	N/A	N/A	N/A	1.7 lb	N/A	0.8 kg

Black (BLA), Deep Charcoal Marble (CMARB), Sterling Gray (SGRAY) *4 Panels per pack.

WHEN ORDERING PRODUCTS WITH **BOLD** COLOR CODES, PLEASE SPECIFY COLOR CODE AFTER THE PRODUCT NUMBER. SEE THE PRODUCT COLOR GUIDE AT THE BACK OF THE CATALOG.



This symbol, positioned with Decorative Receptacle refuse containers, indicates post-consumer recycled content (30% for steel, 70% for aluminum).

Metropolitan Smokers' Station

Introducing Rubbermaid's solution to smoking litter management: Metropolitan is a stylish all-metal, high-capacity smokers' station.



USER-FRIENDLY
Stainless steel snuff plates on both sides of unit.

WEATHERPROOF FINISH
Long-lasting Uni-Koat® powder-coated finish.

AESTHETIC AND DURABLE
All-metal construction in a slim, contemporary design



EASY TO EMPTY
Hinged lid flips open to provide complete access to the 1.6-gal galvanized liner. Simply lift out liner, discard waste, and reinsert.



SECURITY FEATURES
Integrated keyed cam lock secures lid against tampering and helps reduce replacement costs.



WEIGHTED BASE AND BOLT-DOWN CAPABILITY
Base features holes for standard 3/8" lag or concrete bolts (not included) and is weighted for stability.

FGR93400BK

FGR93400SM

No.	Color	Description	Capacity (Gal)	Capacity (Liters)	U.S. Dimensions	U.S. Ship Wt/Ctn	Metric Dimensions	Metric Ship Wt/Ctn
FGR93400	BK, SM	Metropolitan Smokers' Station	1.6 gallons Approx. 1,800 cigarettes	6.06 liters	16.8" dia x 42.8" h	39 lb	42.7 cm dia x 108.7 cm	17.7 kg

Black (BK), Silver Metallic (SM)

Smokers' Pole

Simple, space-saving solution for controlling smokers' waste.

- Easy-to-empty design requires no tools and minimal bending
- Weather-resistant, powder-coated, fire-safe aluminum
- Recessed extinguishing screen



ADA COMPLIANT



FGR1SM



FGR1BK



1. Remove top using quick-release push-button.



2. Detach unit at midpoint, using quick-release push-button.



3. Empty contents.

No.	Color	Description	Capacity (Gal)	Capacity (Liters)	U.S. Dimensions	U.S. Ship Wt/Ctn	Metric Dimensions	Metric Ship Wt/Ctn
FGR1	BK, SM	Smokers' Pole	N/A	N/A	4" dia x 12.75" w x 41" h	24.0 lb	10.2 cm dia x 32.4 cm x 104.1 cm	10.9 kg

Black (BK), Silver Metallic (SM)

WHEN ORDERING PRODUCTS WITH **BOLD** COLOR CODES, PLEASE SPECIFY COLOR CODE AFTER THE PRODUCT NUMBER. SEE THE PRODUCT COLOR GUIDE AT THE BACK OF THE CATALOG.



This symbol, positioned with Decorative Receptacle refuse containers, indicates post-consumer recycled content (30% for steel, 70% for aluminum).

Infinity™ Smoking Management Solutions

Sophisticated styling and all-metal construction for attractive and efficient smoking litter management.

- High-capacity receptacles for heavy traffic areas
- Stainless steel snuff plates
- Weighted bases and bolt-down options for added stability outdoors
- 360° disposal area
- Domed tops for weather resistance
- Integrated padlock tabs provide security against tampering and theft



CSFM



See it in ACTION
www.rubbermaidinfinity.com



Recessed extinguishing screen snuffs small butts and avoids smoldering.



Curved cap prevents items or trash being placed on the top and water from entering the canister.



Integrated padlock tabs provide security against tampering and theft.



Holes to bolt to ground help the container remain stable and add security.



No.	Color	Description	Capacity (Gal)	Capacity (Liters)	Cigarette Count	U.S. Dimensions	U.S. Ship Wt/Ctn	Metric Dimensions	Metric Ship Wt/Ctn
FG9W3100	SSBLA	Infinity™ Base-Mount Smoking Receptacle	1.3	4.9	1,500*	15.5" w x 39.63" h	23.3 lb	39.4 cm x 100.7 cm	10.6 kg
FG9W3200	SSBLA	Infinity™ Wall-Mount Smoking Receptacle	0.6	2.3	700*	11.63" w x 18" h	12.0 lb	29.5 cm x 45.7 cm	5.4 kg
FG9W3300	BLA, ATPWTR, AGBRNZ	Infinity™ Traditional Smoking Receptacle	4.1	15.5	5,000*	13" w x 39" h	23.8 lb	33 cm x 99.1 cm	10.8 kg
FG9W3400	BLA, ATPWTR, AGBRNZ	Infinity™ Ultra-High-Capacity Smoking Receptacle	6.7	25.4	8,000*	15.5" w x 41.5" h	32.5 lb	39.4 cm x 105.4 cm	14.7 kg
FG9W3101	SSSTL	Infinity™ Base-Mount Stainless Replacement Canister	1.33	5.1	1500*	N/A	5.0 lb	N/A	2.3 kg
FG9W3201	SSSTL	Infinity™ Wall-Mount Stainless Replacement Canister	0.6	2.3	700*	N/A	3.0 lb	N/A	1.4 kg
FG9W3301	SILV	Infinity™ Traditional Galvanized Replacement Bucket	4.13	15.7	5,000*	N/A	3.5 lb	N/A	1.6 kg

Aged Bronze (AGBRNZ), Antique Pewter (ATPWTR), Black (BLA), Silver (SILV), Stainless Steel/Black Top (SSBLA), Stainless Steel (SSSTL)

*Based on estimated 1,200 cigarette butts per gallon.

Aladdin Smokers' Station®

Weather-resistant, fire-safe steel construction will not burn.

- Factory Mutual-approved fire-safe/self-extinguishing
- Oxygen-restricting design quickly extinguishes cigarettes
- Nylon base pads prevent damage to surface and base
- Stainless steel latches and nickel-plated brass chain
- Optional anchoring kits available



Stainless steel latches require no tedious, time-consuming alignment to fasten. Forms a tight-fitting seal.

Top and base connected with nickel-plated brass chain to deter theft.

GroundsKeeper® Receptacles

Classic, all-weather solution to an unsightly environmental problem.

- Hygienic, easy-to-service steel canister
- Restricted opening shields waste from view, weather, and flow of oxygen
- Galvanized steel inner canister holds large quantities of cigarette waste
- Steel base plate adds stability and discourages theft
- Optional Weight Ring (FG628400) available for added stability

FG9W3000's Tuscan style combines clean good looks with easy maintenance.

- Design blends with many styles
- Stainless steel snuff plate
- Anchor holes for added security



ALADDIN SMOKERS' STATION®

No.	Color	Description	Capacity (Gal)	Capacity (Liters)	U.S. Dimensions	U.S. Ship Wt/Ctn	Metric Dimensions	Metric Ship Wt/Ctn
FGR1639E	HBZ, HGR	Aladdin Smokers' Station®	41	170	16" dia x 38.75" h	22.0 lb	40.6 cm dia x 98.4 cm	10 kg

Hammertone Bronze (HBZ), Hammertone Charcoal (HGR)

GROUNDKEEPER®

No.	Color	Description	Capacity (Gal)	Capacity (Liters)	U.S. Dimensions	U.S. Ship Wt/Ctn	Metric Dimensions	Metric Ship Wt/Ctn
FG257088*	BRN, BLA, BEIG	GroundsKeeper® Smoking Management Receptacle	N/A	N/A	12.25" sq x 39.4" h	15.5 lb	31.1 cm sq x 100.1 cm	7 kg
FG628400	BLA	Weight Ring — Single for all 36" (91.4 cm) Safety Cones	N/A	N/A	12.5" l x 12.5" w x 1" h	10.0 lb	31.8 cm x 31.8 cm x 2.5 cm	4.5 kg
FG9W2900	0000	Security Kit for GroundsKeeper® Tuscan Receptacle	N/A	N/A	N/A	2.8 lb	N/A	1.3 kg
FG9W3000	BLA, SSTON	GroundsKeeper® Tuscan Receptacle	N/A	N/A	13" sq x 38.38" h	15.4 lb	33 cm sq x 97.5 cm	7 kg

Black (BLA), Beige (BEIG), Brown (BRN), Sandstone (SSTON), No Color (0000)
 *Custom imprinting available; contact Rubbermaid Customer Service at (800) 347-9800.

WHEN ORDERING PRODUCTS WITH **BOLD** COLOR CODES, PLEASE SPECIFY COLOR CODE AFTER THE PRODUCT NUMBER. SEE THE PRODUCT COLOR GUIDE AT THE BACK OF THE CATALOG.



This symbol, positioned with Decorative Receptacle refuse containers, indicates post-consumer recycled content (30% for steel, 70% for aluminum).

Smokers' Station® Wall Mount

Simply snuff out cigarettes on the extinguishing screen and drop into the receptacle.

- Recessed extinguishing screen prevents ashes from falling to the ground
- Heavy-gauge, hot-dipped galvanized, powder-coated, or stainless steel
- Mounting hardware included
- Keyed camlock helps prevent tampering



FGR1012E / FGR1012SS



Easy emptying.



Optional surface mount and in-ground poles accommodate 1 or 2 models. FGSSSM / FGSSIG

Classic Smoking Urns and Accessories

Perfect in lobbies and hallways.

- Available with side opening for Class A refuse collection
- One-piece, wall-mounted smoking urn is easy to empty and clean



FG258600

FG258500



FGU718



FGU650

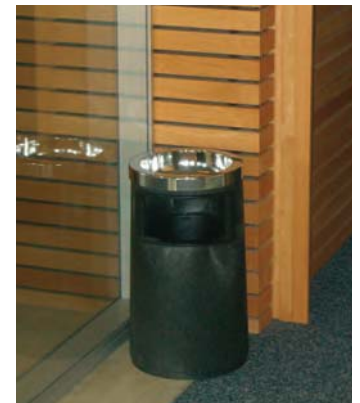

SMOKERS' STATION® WALL MOUNT

No.	Color	Description	Capacity (Gal)	Capacity (Liters)	U.S. Dimensions	U.S. Ship Wt/Ctn	Metric Dimensions	Metric Ship Wt/Ctn
FGR1012	SS	Smokers' Station® Wall-Mount Urn w/ Keyed Cam Lock	N/A	N/A	10" w x 12.5" h	7.0 lb	25.4 cm x 31.8 cm	3.2 kg
FGR1012E	BK	Smokers' Station® Wall-Mount Urn w/ Keyed Cam Lock	N/A	N/A	10" w x 12.5" h	7.0 lb	25.4 cm x 31.8 cm	3.2 kg
FGSSSM		Smokers' Station® Wall-Mount/Surface-Mount Pole w/Hardware for FGR1012	N/A	N/A	2" dia x 51" h	19.0 lb	5.1 cm dia x 129.5 cm	8.6 kg
FGSSIG		Smokers' Station® Wall-Mount In-Ground Pole w/ Hardware for FGR1012	N/A	N/A	2" dia x 69" h	21.0 lb	5.1 cm dia x 175.3 cm	9.5 kg

Black (BK), Stainless Steel (SS)

CLASSIC SMOKING URNS AND ACCESSORIES

No.	Color	Description	Capacity (Gal)	Capacity (Liters)	U.S. Dimensions	U.S. Ship Wt/Ctn	Metric Dimensions	Metric Ship Wt/Ctn
FG258500	BLA	Classic Smoking Urn with Metal Ashtray Top	N/A	N/A	11.5" dia x 19.5" h	8.4 lb	29.2 cm dia x 49.5 cm	3.8 kg
FG258600	BLA	Classic Smoking Urn, Ash/Trash w/ Metal Ashtray Top and Metal Liner	N/A	N/A	12.5" dia x 19.5" h	9.7 lb	31.8 cm dia x 49.5 cm	4.4 kg
FGU650	SA	Smokers' Station® Wall-Mount Urn	N/A	N/A	9.5" w x 8" h	5.0 lb	24.1 cm x 20.3 cm	2.3 kg
FGU718	MC	Smokers' Station® Wall-Mount Urn	N/A	N/A	4.5" dia x 3" h	6.0 lb	11.4 cm dia x 7.6 cm	2.7 kg

Black (BLA), Satin Aluminum (SA), Mirror Chrome (MC)

ASH/TRASH ACCESSORIES

No.	Color	Description	Capacity (Gal)	Capacity (Liters)	U.S. Dimensions	U.S. Ship Wt/Ctn	Metric Dimensions	Metric Ship Wt/Ctn
FG258100	BLA	Classic Smoking Urn Insert Tray, Round for FG258200 Base	N/A	N/A	10.63" dia x 2.25" h	5.4 lb	27 cm dia x 5.7 cm	2.4 kg
FG258200	BLA	Classic Smoking Urn Base, Floor Model	N/A	N/A	10.38" dia x 18" h	10.0 lb	26.4 cm dia x 45.7 cm	4.5 kg
FG258800	CHRM	Classic Metal Ashtray Top, Round for FG258500, FG258600 Bases	N/A	N/A	10.63" dia x 2.25" h	5.8 lb	27 cm dia x 5.7 cm	2.6 kg

Black (BLA), Chrome (CHRM)

Ash/Trash Containers

Combines waste and smoking management for increased efficiency.

CLASSIC CONTAINERS

- Ashtray can be permanently attached or left unattached for easy emptying
- Retainer hardware secures and conceals can liners
- Doors on both sides provide easy access for trash disposal

STEEL CONTAINERS

- Fire-safe construction
- Stainless steel containers are constructed with rust-resistant, heavy-gauge #304 material
- Powder-coated containers are constructed with heavy-gauge galvanized steel
- Protective trim on all openings protects containers and helps reduce potential for injury
- Spun aluminum ashtray



ADA COMPLIANT



Funnel Top



Sand Top



FG1100EBK

ASH/TRASH CLASSIC CONTAINERS

No.	Color	Description	Capacity (Gal)	Capacity (Liters)	U.S. Dimensions	U.S. Ship Wt/Ctn	Metric Dimensions	Metric Ship Wt/Ctn
FG818088	BRN, BEIG	Ash/Trash Classic Container with Doors	25	94.6	18" dia x 42.25" h	27.7 lb	45.7 cm dia x 107.3 cm	12.6 kg
FG818288*	BEIG	Ash/Trash Classic Container without Doors	25	94.6	18" dia x 42.25" h	26.0 lb	45.7 cm dia x 107.3 cm	11.8 kg
FG818488	BEIG	Ash/Trash Classic Container with Doors	15	56.8	15.5" dia x 38" h	21.3 lb	39.4 cm dia x 96.5 cm	9.7 kg
FG818588*	BEIG	Ash/Trash Classic Container without Doors	15	56.8	12.5" dia x 38" h	19.6 lb	31.8 cm dia x 96.5 cm	8.9 kg
FG355000	GRAY	Rigid Liner for FG818088, FG818488, FG818588 Containers	12.1	45.9	12" dia x 27.25" h	16.2 lb	30.5 cm dia x 69.2 cm	7.3 kg
FG355200	GRAY	Rigid Liner with Rim for FG818288 Containers	22	83.3	14.5" dia x 30.13" h	26.9 lb	36.8 cm dia x 76.5 cm	12.2 kg

Beige (BEIG), Brown (BRN), Gray (GRAY) * Provides hands-free use.

ASH/TRASH STEEL CONTAINERS

No.	Color	Description	Capacity (Gal)	Capacity (Liters)	U.S. Dimensions	U.S. Ship Wt/Ctn	Metric Dimensions	Metric Ship Wt/Ctn	Liner
FG1100	SSS	Steel Receptacle Ash/Trash	3.5	13.2	10" dia x 27" h	12.0 lb	25.4 cm dia x 68.6 cm	5.4 kg	PL
FG1100E	BK	Steel Receptacle Ash/Trash	3.5	13.2	10" dia x 27" h	12.0 lb	25.4 cm dia x 68.6 cm	5.4 kg	PL

Galvanized Liner (GL), Plastic Liner (PL) Almond (AL), Black (BK) ¹UL-Listed, FM, CSFM
 Custom options available on pgs 286–291. Call Customer Service for pricing.

WHEN ORDERING PRODUCTS WITH **BOLD** COLOR CODES, PLEASE SPECIFY COLOR CODE AFTER THE PRODUCT NUMBER. SEE THE PRODUCT COLOR GUIDE AT THE BACK OF THE CATALOG.



This symbol, positioned with Decorative Receptacle refuse containers, indicates post-consumer recycled content (30% for steel, 70% for aluminum).

Decorative Planters

For more information, please contact your Rubbermaid Commercial Products' Sales Representative.



Model T

Model K



Model P



Model L

DECORATIVE PLANTERS

No.	Color	Description	U.S. Dimensions	Metric Dimensions
FGFGPL-Model L	**	Galleria Planter	10" dia x 12" h to 42" dia x 35" h	25.4 cm dia x 30.5 cm to 106.7 cm dia x 88.9 cm
FGFGPK-Model K	**	Mediterranean Planter	18" dia x 12" h to 72" dia x 48" h	45.7 cm dia x 30.5 cm to 182.9 cm dia x 121.9 cm
FGFGPM-Model M	**	Round Rimless Planter	7" dia x 5" h to 24" dia x 22" h	17.8 cm dia x 12.7 cm to 60.9 cm dia x 55.9 cm
FGFGPN-Model N	**	Rectangular Planter w/ Return Rim	48" l x 12" w x 12" h to 96" l x 24" w x 33" h	121.9 cm x 30.5 cm x 30.5 cm to 243.8 cm x 61 cm x 83.8 cm
FGFGPO-Model O	**	Square Planter w/ Return Rim	11" dia x 8" h to 96" dia x 42" h	27.9 cm dia x 20.3 cm to 243.8 cm dia x 106.7 cm
FGFGPP-Model P	**	Round Planter w/ Return Rim	16" sq x 12" h to 72" sq x 42" h	40.6 cm sq x 30.5 cm to 182.9 cm sq x 106.7 cm
FGFGPT-Model T	**	Tuscany Planter	21" sq x 18" h to 36" sq x 24" h	53.3 cm sq x 45.7 cm to 91.4 cm sq x 61 cm

** Gel-Coat colors are standard. See pgs 286–291 for other available colors, finishes, and labeling options. Call Customer Service for pricing.

LINERS FOR DECORATIVE REFUSE CONTAINERS

Product	Liner Shape	Plastic Liner	Galvanized Liner	Dimensions (Inches)	Liner Capacity (G)
FG200	Square		GL200	6 x 15 x 27	10.5
FG1100	Round	L1100		9 dia x 14.5	3.5
FG1219	Round	L1227		10 dia x 18	6.5
FG1227	Round	L1227		10 dia x 18	6.5
FG13	Square	L13		9 x 9 x 6.75	2.4
FG135	Rect	L135		8.25 x 5.25 x 6.75	1.3
FG1628LO	Round	FG355000GRAY	GL1536	14 dia x 24.25	15
FG1630	Round	FG355000GRAY	GL1536	14 dia x 24.25	15
FG1630SQ	Square	L140		14.5 x 14.5 x 28	20
FG1639	Round	FG355000GRAY	GL1536	14 dia x 24.25	15
FG1639DR	Round	FG355000GRAY		14 dia x 24.25	15
FG1829	Round	L1824	GL1824	15.38 dia x 25.25	20
FG1830ARLO	Round	L1830		14.5 dia x 28	18
FG1830LO	Round	L1830		14.5 dia x 28	18
FG1830SUT	Round	L1824		15.38 dia x 25.25	20
FG1837	Round	L1824		15.38 dia x 25.25	20
FG2030SQ	Square	L2434	GL2434	17.5 x 17.5 x 25.25	29
FG2032	Round	L2032		17.25 dia x 27.38	26
FG2037SQ	Square	L2434	GL2434	17.5 x 17.5 x 25.25	29
FG2038SQ	Square	L2434	GL2434	17.5 x 17.5 x 25.25	29
FG2432	Round	L2432BR	GL2432	22.5 dia x 27	36
FG2432AR	Round	L2432BR		22.5 dia x 27	36
FG2432SQ	Square	L38	GL38	21.75 x 21.75 x 24.25	38
FG2438	Round	L2438		21.88 dia x 32	50
FG2438SQ	Square	L38	GL38	21.75 x 21.75 x 24.25	38
FG2439	Round	L2432BR	GL2432	22.5 dia x 27	36
FG2439DR	Round	L2432BR		22.5 dia x 27	36
FG2448SQ	Square	L38	GL38	21.75 x 21.75 x 24.25	38
FG2449SQ	Square	L38	GL38	21.75 x 21.75 x 24.25	38
FGA17	Round	LA17		16 dia x 24.5	17
FGA38	Round	LA38		21.75 dia x 33	38
FGA38SD	Round	LA38SD		21.5 dia x 22.5	31
FGA51	Round	LA5		10 dia x 15.75	5
FGAOT15	Round	FG355000GRAY		14 dia x 24.25	15
FGAOT30	Round	LG30		18.5 dia x 31	30
FGAOT35	Round	FG355200GRAY	GL1842	16 dia x 29.25	21
FGAOT62	Round	L45		22.25 dia x 22.25	55
FGAOU20	Round	L1536ST	GL1536ST	13.5 dia x 26.75	15
FGAOU63	Round	LG30		18.5 dia x 31	30
FGATF18	Round	L18		12.5 dia x 26	15
FGATF3020	Round	LG30		18.5 dia x 31	30
FGB1424	Square	L24		12.5 x 12.5 x 27	16
FGB1940	Square	L40		16.25 x 16.25 x 27	29
FGC1630	Round	3FG55000GRAY		14 dia x 24.25	15
FGC2035	Round	L2032		17.25 dia x 27.38	26
FGC2044	Round	L2032		17.25 dia x 27.38	26
FGC2437	Round	L2438		21.88 dia x 32	50
FGC2446	Round	L2438		21.88 dia x 32	50
FGCC16	Round		GL1536	14 dia x 24.25	15
FGDCR24	Square	L40		16.25 x 16.25 x 27	29
FGDRR24	Round	L2032		17.25 dia x 27.38	26
FGH2436	Semi	HP1		10 x 5.25 x 26	18
FGK1824	Round	LH1		10 dia x 20.5	7
FGK2130	Round	L1536ST		13.5 dia x 26.75	15
FGK2433	Round	FG355200GRAY		16 dia x 29.25	21
FGK2736	Round	L2736		18 dia x 34	33
FGK2836	Round	L2836		20 dia x 34	37
FGK2936	Round	L2836		21 dia x 34	37
FGKSM32	Round	FG355200GRAY		16 dia x 29.25	21
FGKSR12	Square	LH12		11.75 x 11.75 x 22.25	12
FGKSR36	Square	L40		16.25 x 16.25 x 27	29
FGKSR48SD	Square	L150		19.38 x 19.38 x 29	40
FGL140MOD	Square	L140		14.5 x 14.5 x 28	20
FGL2030	Round	LG30		18.5 dia x 31	30
FGL2433	Square	L150		19.38 x 19.38 x 29	40
FGLBB2BK	Square	LBB2BK		23 x 23 x 24.5	0

LINERS FOR DECORATIVE REFUSE CONTAINERS

Product	Liner Shape	Plastic Liner	Galvanized Liner	Dimensions (Inches)	Liner Capacity (G)
FGLBB3BK	Rect	LBB3BK		20.25 x 24.5 x 24.5	0
FGMH24	Round	LMH24BK		15.47 dia x 31.5	23
FGMH32	Round	LMH32BK		19.5 dia x 29.38	32
FGMH46	Round	L46		19.70 dia x 31.5	46
FGMHR36	Rect	LR36		12.75 x 27.03 x 27.91	36
FGMHSQ18	Square	LH18		12.75 x 12.75 x 27.91	18
FGR11	Square	L41		8.5 x 8.5 x 12.25	2.5
FGR12	Square	LH12		11.75 x 11.75 x 22.25	12
FGR14	Square	LH12		11.75 x 11.75 x 22.25	12
FGR1530	Round	L1530	GL1530	14 dia x 20.75	12
FGR1536	Round	FG355000GRAY	GL1536	14 dia x 24.25	15
FGR1536ST	Round	L1536ST	GL1536ST	13.5 dia x 26.75	15
FGR18	Square	L36SD		16 x 16 x 22	24
FGR1842	Round	FG355200GRAY	GL1842	16 dia x 29.25	21
FGR23	Round	L1530		14 dia x 20.75	12
FGR2416	Rect	L2416	GL3616 (2)	10.5 x 14.25 x 24	16
FGR25	Round	FG355000GRAY		14 dia x 24.25	15
FGR32	Round	FG355000GRAY	GL1536	14 dia x 24.25	15
FGR3418	Square	L140		14.5 x 14.5 x 28	20
FGR34HT	Square	L2434		17.5 x 17.5 x 25.25	29
FGR3616	Rect	L2416	GL3616 (3)	10.5 x 14.25 x 24	16
FGR36HT	Square	L2434		17.5 x 17.5 x 25.25	29
FGR38HT	Square	L38		21.75 x 21.75 x 24.25	38
FGR38SD	Square	L38SD		21 x 21 x 22.25	38
FGR41	Square	L41		8.5 x 8.5 x 12.25	2.5
FGR4816	Rect	L2416	GL130 (2), DGL130 (2)	10.5 x 14.25 x 24	16
FGR48HT	Square	L48		22.25 x 22.25 x 26.25	48
FGRS220	Rect	HP2		20 x 10 x 30	23
FGRS220	Round	FG355000GRAY		14 dia x 24.25	15
FGRS220	Round	FG355200GRAY		16 dia x 29.25	21
FGRS6	Round	L2432BR		22.5 dia x 27	36
FGS3	Round	L3		16 dia x 33.25	25
FGS55	Round	L51		22 dia x 34.5	51
FGSC10	Square	L10		8.31 x 8.31 x 22.5	6
FGSC14	Square	L24		12.5 x 12.5 x 27	16
FGSC18	Square	L40		16.25 x 16.25 x 27	29
FGSC22	Square	L150		19.38 x 19.38 x 29	40
FGSH12	Semi	L8MOD		17 x 8 x 32	12
FGSIG4120	Square	L41		8.5 x 8.5 x 12.25	2.5
FGSIG4125	Square	L41		8.5 x 8.5 x 12.25	2.5
FGSM1	Round	L51		22 dia x 34.5	51
FGSM3	Round	L51		22 dia x 34.5	51
FGSM4	Square	L38		21.75 x 21.75 x 24.25	38
FGSM5	Square	L38		21.75 x 21.75 x 24.25	38
FGSO12	Semi	L8MOD		17 x 8 x 32	12
FGSO16	Round	L1530	GL1530	14 dia x 20.75	12
FGSO8	Semi	L8		17 x 8 x 20.13	9
FGSR14	Rect	LR14		17.5 x 8 x 27.69	13
FGSR18	Rect	LR18		22.25 x 10.38 x 27.69	22.5
FGST12	Square	L12		10 x 10 x 20.5	12
FGST24	Square	L24		12.5 x 12.5 x 27	16
FGST35	Round	L35	GL35	9.25 dia x 13	3.5
FGST40	Square	L40		16.25 x 16.25 x 27	29
FGST7	Square	L7		10 x 10 x 14.25	7
FGT1424	Square	L24		12.5 x 12.5 x 27	16
FGT1940	Square	L40		16.25 x 16.25 x 27	29
FGR1012	Square		GL1012	2.75 x 10 x 7	1
FGR1639	Round		GL1639	13.5 dia x 9	5.6
FGSIG5210	Round	L52		9 dia x 24.5	6.5
FGSIG5220	Round	L52		9 dia x 24.5	6.5
FGSO17	Round		GL1536	14 dia x 26.5	17.7
FGST5	Round		GL5	9.75 dia x 17.5	5.6

WHEN ORDERING PRODUCTS WITH **BOLD** COLOR CODES,
PLEASE SPECIFY COLOR CODE AFTER THE PRODUCT NUMBER.
SEE THE PRODUCT COLOR GUIDE AT THE BACK OF THE CATALOG.



Check out the items marked with this symbol for
our new line of Executive Series™ products.



PLATFORM TRUCKS

Convertible A-Frame Truck	208
Convertible Platform Trucks	209
Heavy-Duty Platform Trucks	210
Caster Guide	211
Sheet and Panel Trucks and A-Frame Panel Trucks	212
Work-Height Platform Trucks	213
5th Wheel Wagon Trucks	214
Side-Panel Platform Trucks	215
Stanchion Platform Trucks	216
Semi-Live Skids	217
Dunnage Racks	217
StockMate® Restocking Trucks	218
Triple® Trolley	218
Heavy-Duty Dollies	218

WORKSTATIONS

TradeMaster® Mobile Cabinets and Work Centers	219
Trades Carts	220
5-Drawer Mobile Work Center	220
Ladder Cart	221

UTILITY AND SERVICE CARTS

Heavy-Duty Utility and Service Carts	222
Convertible Utility Cart	224
Executive Service Cart	225
Service Carts	226
Xtra™ Carts	227

SHELVING AND AUDIO-VISUAL CARTS

Shelving Systems	228
Media Master® Audio-Visual Carts	228
Cart Accessories	229

BULK TRUCKS

Structural Foam Tilt Trucks	231
Rotomolded Tilt Trucks	232
Heavy-Duty Towable Tilt Trucks	233
Heavy-Duty Forkliftable Tilt Trucks	233
Heavy-Duty Tilt Truck Lids	233
Self-Dumping Hoppers	234
Cube Trucks	235

STORAGE

BRUTE® Totes	236
Stack and Nest Palletote® Boxes	236
Tool Boxes	236
Tack Box with Padded Top	236
ActionPacker® Storage Containers	237

FARM AND GARDEN

Stock Tanks	237
Heavy-Duty Tractor Carts	238
Big Wheel® Carts	238
Heavy-Duty Big Wheel® Cart	239
Contractor-Grade Wheelbarrows	239
Utility Lawn Carts	239



Smart. Rugged. Trusted.

A New Standard of Excellence in Heavy-Duty Platform Trucks and Carts

We've significantly redesigned and expanded our material handling line with new categories, new products, and new innovations that help you work smarter, faster, and safer.



DURAMOLD™ REAL WORLD RUGGED — TESTED TOUGH

Rubbermaid's exclusive Duramold™ technology exceeds the highest performance standards in the industry. We test and retest our products to meet rigorous durability standards, and our new material handling products are no exception. Real-world rugged durability, innovative technology, and best-in-class features combine to create longer-lasting products that carry heavy loads—and make your work easier.

DURAMOLD™
precision engineered resin and steel composite decks
HOLD & TRANSPORT UP TO

2500 lbs.
of weight load capacity



40 buckets of sheetrock compound weigh over 2,400 lbs—that's a load!

WILL NOT WARP, DENT, SPLINTER, RUST, OR ROT

Tough, resilient surface absorbs impact and provides quiet operation. Virtually maintenance-free; resistant to most chemicals, impervious to water damage, and easily cleaned.



Metal—dents and rusts



Wood—splinters and rot

MOVE LOADS SAFELY AND EFFICIENTLY

The variable grip-height handle on our carts and trucks improves maneuverability and reduces muscle strain for most every user, regardless of height.



TRADITIONAL CART HANDLE DESIGN

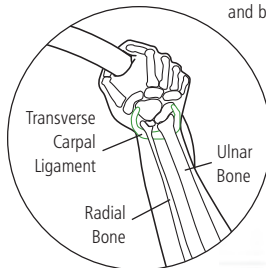

Angled handle helps keep wrist and bones in forearm aligned for optimum leverage while turning.

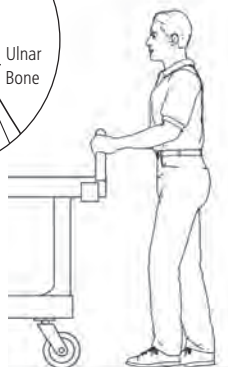

IMPROVED VARIABLE GRIP-HEIGHT HANDLE

DURAMOLD™



Duramold™ decks are formed from a precision-engineered resin and metal composite structure that is lighter than typical steel/wood products without sacrificing strength, which enables weight reduction and improved ergonomics.

PUT YOUR EFFORT INTO MOVING YOUR PAYLOAD, NOT YOUR TRUCK

DURAMOLD™ HAS THE HIGHEST STRENGTH-TO-WEIGHT RATIO

when compared to metal, wood, and solid plastic decks.

35%

lighter weight construction to transport the same payload



Duramold™ resin and metal composite structure is recyclable.

Convertible A-Frame Truck

Our unique design combines the bulk load capacity of standard panel trucks and bar stock trucks with the functionality of a heavy-duty two-shelf cart. Saves time and money by transporting oversized, heavy loads to your work site in one trip.

DURAMOLD

DECK SIZE:

27 1/4" X 56 1/2"

MAX. CAPACITY (lbs)

2000

See it in ACTION

www.rcpmaterialhandling.com

CASTER DESCRIPTIONS See "Caster Guide"



TWO FIXED AND TWO LOCKING SWIVEL CASTERS

Two locking polyolefin casters allow for added stability when loading and unloading.

KEEP TOOLS AND SUPPLIES ORGANIZED

Independent fold-down top shelves hold small items, tools, and supplies; 100-lb capacity per side.

KEEP LOADS SECURE

A-frame configuration holds sheet goods securely in place.

EASY CONVERTIBILITY

Spring-loaded release latches safely allow one or both top shelves to be folded down.

HANDLE OVERSIZED LOADS

Four independent articulating outrigger arms fold down to cradle lumber, pipe, and bar stock; 100 lb capacity per arm.

IMPROVE PRODUCTIVITY

Large deck surface holds up to 12" depth of sheet goods, 6" on either side.

RUGGED CONSTRUCTION

Duramold's™ exclusive, precision-engineered resin and metal composite structure provides maximum load support.



FG446500

MULTIPLE CART & TRUCK CONFIGURATIONS IN ONE PRODUCT!

MULTIPLE CONFIGURATIONS TO HANDLE ANY JOB

No.	Color	Description	U.S. Dimensions	U.S. Capacity	U.S. Ship Wt/Ctn	Metric Dimensions	Metric Capacity	Metric Ship Wt/Ctn	Caster Type	Pack
FG446500	BLA	Convertible A-Frame Truck (24" x 44")	51.125" l x 28.125" w x 17.25" h	2,000 lb	133.0 lb	129.9 cm x 71.4 cm x 43.8 cm	907.2 kg	60.3 kg	8" Polyolefin	1

WHEN ORDERING PRODUCTS WITH **BOLD** COLOR CODES, PLEASE SPECIFY COLOR CODE AFTER THE PRODUCT NUMBER. REFER TO THE PRODUCT COLOR GUIDE AT THE BACK OF THE CATALOG.



Check out the items marked with this symbol for our new line of Executive Series™ products.

Convertible Platform Trucks

Work more efficiently by transporting heavy loads, tools, and supplies with a single product.

- Three-in-one convertible design
- Quickly transforms from a standard platform truck or U-boat configuration into a two-shelf cart

DURAMOLD

DECK SIZE:

CART
24" X 44"
TRUCK
24" X 52"

Max. Capacity: 750 lbs cart;
1000 lbs truck

CAPACITY RANGE (lbs)
750-1000

See it in ACTION

www.rcpmaterialhandling.com

CASTER DESCRIPTIONS
See "Caster Guide"

CART CONFIGURATION

Two-shelf heavy-duty cart holds up to 750 lbs.

QUICK CONVERSION

Push-button release latch makes conversion from heavy-duty cart to platform truck effortless.



FG449700

U-BOAT CONFIGURATION

U-boat configuration helps keep stacked or bulky goods in place; 1,000-lb capacity.



FG449700

RUGGED CONSTRUCTION

Duramold's™ exclusive, precision-engineered resin and metal composite structure provides maximum load support.

BUILT-IN SAFETY FEATURES

Unique slide-locking latches prevent unintended handle removal.

FG449700

PLATFORM TRUCK CONFIGURATION

Removable handle can be repositioned to create a heavy-duty platform truck.



No.	Color	Description	U.S. Dimensions	U.S. Capacity	U.S. Ship Wt/Ctn	Metric Dimensions	Metric Capacity	Metric Ship Wt/Ctn	Caster Type	Pack
FG449600	BLA	Convertible Platform Truck (24" x 52")	61.5" l x 24.25" w x 42.125" h	750 lb as cart, 1,000 lb as platform	106.0 lb	156.2 cm x 61.6 cm x 107.0 cm	340.2 kg as cart, 453.6 kg as platform	48.1 kg	6" TPR	1
FG449700	BLA	Convertible Platform Truck (24" x 52")	61.5" l x 24.25" w x 44.625" h	750 lb as cart, 1,000 lb as platform	121.0 lb	156.2 cm x 61.6 cm x 113.3 cm	340.2 kg as cart, 453.6 kg as platform	54.9 kg	8" Pneumatic	1

Heavy-Duty Platform Trucks

Ideal for moving large, heavy, oversized loads in a variety of environments from retail to construction.

DURAMOLD

DECK SIZES:

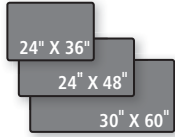

CAPACITY RANGE (lbs)
1000–2500

See it in ACTION
www.rcpmaterialhandling.com

CASTER DESCRIPTIONS
See "Caster Guide"



IMPROVED MANEUVERABILITY
Variable grip-height handle improves control and worker safety.

VIRTUALLY MAINTENANCE-FREE
Powder-coated steel creates a hard finish that is far tougher than conventional paint.



BUILT-IN SAFETY FEATURES
Retainer clips prevent unintended handle removal.

SECURE SMALL ITEMS
Perimeter deck channel retains small items.

KEEP LOADS IN PLACE
Textured deck surface reduces load slippage.

RUGGED CONSTRUCTION
Duramold's™ exclusive, precision-engineered resin and metal composite structure provides maximum load support.



BETTER LOAD RETENTION
Four molded-in tie-down slots for securing loads with tie-down straps or bungees.

No.	Color	Description	U.S. Dimensions	U.S. Capacity	U.S. Ship Wt/Ctn	Metric Dimensions	Metric Capacity	Metric Ship Wt/Ctn	Caster Type	Pack
FG440300	BLA	Heavy-Duty Platform Truck	36" l x 24" w	1,000 lb	50.0 lb	91.4 cm x 61 cm	453.6 kg	22.7 kg	6" TPR	1
FG440600	BLA	Heavy-Duty Platform Truck	36" l x 24" w	2,000 lb	50.0 lb	91.4 cm x 61 cm	907.2 kg	22.7 kg	6" Polyolefin	1
FG443600	BLA	Heavy-Duty Platform Truck	48" l x 24" w	2,000 lb	70.0 lb	121.9 cm x 61 cm	907.2 kg	31.8 kg	8" TPR	1
FG443610	BLA	Heavy-Duty Platform Truck	48" l x 24" w	1,200 lb	75.0 lb	121.9 cm x 61 cm	544.3 kg	34 kg	8" Pneumatic	1
FG444100	BLA	Heavy-Duty Platform Truck	48" l x 24" w	2,500 lb	69.0 lb	121.9 cm x 61 cm	1,134.0 kg	31.3 kg	8" Polyolefin	1
FG446600	BLA	Heavy-Duty Platform Truck	60" l x 30" w	2,000 lb	87.9 lb	152.4 cm x 76.2 cm	907.2 kg	39.9 kg	8" TPR	1
FG446610	BLA	Heavy-Duty Platform Truck	60" l x 30" w	1,200 lb	90.0 lb	152.4 cm x 76.2 cm	544.3 kg	40.8 kg	8" Pneumatic	1
FG447100	BLA	Heavy-Duty Platform Truck	60" l x 30" w	2,500 lb	84.0 lb	152.4 cm x 76.2 cm	1,134.0 kg	38.1 kg	8" Polyolefin	1
FG9T1100	BLA	Heavy-Duty Platform Truck	70" l x 40" w	1,000 lb	126.5 lb	177.8 cm x 101.6 cm	453.6 kg	57.4 kg	6" TPR	1
FG9T1200	BLA	Heavy-Duty Platform Truck	70" l x 40" w	1,000 lb	126.5 lb	177.8 cm x 101.6 cm	453.6 kg	57.4 kg	8" Pneumatic	1
FG9T2100	BLA	Heavy-Duty Platform Truck	70" l x 40" w	2,000 lb	126.5 lb	177.8 cm x 101.6 cm	907.2 kg	57.4 kg	8" Polyolefin	1
FG9T0900	BLA	Side Panel Package, fits FG9T1100, FG9T1200, FG9T2100 (4 sides and 2 end panels)	N/A	N/A	55.9 lb	N/A	N/A	25.4 kg	N/A	1

WHEN ORDERING PRODUCTS WITH **BOLD** COLOR CODES, PLEASE SPECIFY COLOR CODE AFTER THE PRODUCT NUMBER. REFER TO THE PRODUCT COLOR GUIDE AT THE BACK OF THE CATALOG.



Check out the items marked with this symbol for our new line of Executive Series™ products.

CASTERS TO MEET YOUR NEEDS

Rubbermaid's best-in-class heavy-duty casters have been specially chosen for each of our products to meet your most demanding environments.



POLYOLEFIN

Hard-tread polyolefin casters roll easier than soft tread casters. Nonmarking, impact- and chemical-resistant casters won't flat-spot under static loads or pick up metal shavings, nails, and other debris.



PNEUMATIC

Pneumatic casters provide a cushioned and quiet ride for fragile loads, making them ideal for rough and uneven surfaces, inside and out.



THERMOPLASTIC RUBBER (TPR)

TPR casters absorb shock and provide floor surface protection and quiet operation. Chemical- and water-resistant.



Polyolefin



Pneumatic

CASTER PERFORMANCE GUIDE

	CASTER TREAD MATERIAL	MOLD-ON RUBBER (TPR)	POLYOLEFIN	PNEUMATIC
FLOOR SURFACE	ASPHALT	Excellent	Fair	Excellent
	BRICK	Excellent	Fair	Excellent
	CARPET	Excellent	Good	Excellent
	CONCRETE	Excellent	Good	Excellent
	LINOLEUM / COMPOSITION TILE	Excellent	Fair	Excellent
	STEEL – RIBBED	Good	Fair	Excellent
	STEEL – SMOOTH	Good	Good	Excellent
	TERRAZZO	Excellent	Fair	Excellent
	WOOD	Excellent	Good	Excellent
OPERATING CONDITIONS	MILD CHEMICALS	Fair	Good	Good
	HARSH CHEMICALS	Fair	Fair	Good
	METAL SCRAPS – SMALL	Excellent	Good	Good
	METAL SCRAPS – LARGE	Excellent	Fair	Good
	ANIMAL FATS	Good	Good	Good
	OIL AND GREASE	Fair	Good	Fair
	WATER AND STEAM	Good	Excellent	Good
OTHER FACTORS	FLOOR PROTECTION	Excellent	Good	Excellent
	QUIET OPERATION	Excellent	Fair	Excellent
	CUSHION LOAD	Excellent	N/A	Excellent
	IMPACT RESISTANCE	Excellent	Good	Excellent
	ROLLING EASE	Fair	Excellent	Fair
	ABRASION RESISTANCE (NONCHIPPING)	Fair	Good	Fair
	NON-FLAT-SPOTTING (UNDER STATIC LOAD)	Fair	Excellent	N/A

Sheet and Panel Trucks and A-Frame Panel Trucks

Transport large, bulky sheet goods and hard-to-handle loads such as doors, lumber, drywall, tables, and cubicle walls.

DURAMOLD

DECK SIZES:

- 24" X 36"
- 24" X 48"
- 30" X 60"

MAX. CAPACITY (lbs)
2000

CASTER DESCRIPTIONS
See "Caster Guide"



MOVE HARD-TO-HANDLE LOADS

Three removable powder-coated steel vertical frames provide support for bulky loads. Frames can be removed as needed based on load requirements.



FG446800

BUILT-IN SAFETY FEATURES

Retainer clips lock frames securely in place and prevent unintended removal. Four tie-down points, two on each side, help with load retention.

RUGGED CONSTRUCTION

Duramold's™ exclusive, precision-engineered resin and metal composite structure provides maximum load support.

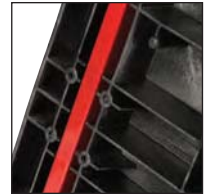

HOLDS SHEET GOODS SECURELY

High-side inclined frame and side rail hold load firmly in place during transit.



FG446300

KEEP LOADS IN PLACE

Textured deck surface reduces load slippage.

See it in ACTION

www.rcpmaterialhandling.com



SHEET AND PANEL TRUCKS

No.	Color	Description	U.S. Dimensions	U.S. Capacity	U.S. Ship Wt/Ctn	Metric Dimensions	Metric Capacity	Metric Ship Wt/Ctn	Caster Type	Pack
FG446700	BLA	Sheet and Panel Truck (24" x 36")	38.75" l x 24.25" w x 38" h	2,000 lb	81.0 lb	98.4 cm x 61.6 cm x 96.5 cm	907.2 kg	36.7 kg	6" Polyolefin	1
FG446800	BLA	Sheet and Panel Truck (24" x 48")	47.9" l x 24.25" w x 39.9" h	2,000 lb	98.0 lb	121.7 cm x 61.6 cm x 101.3 cm	907.2 kg	44.5 kg	8" Polyolefin	1
FG446900	BLA	Sheet and Panel Truck (30" x 60")	59.9" l x 30.25" w x 39.9" h	2,000 lb	117.0 lb	152.1 cm x 76.8 cm x 101.3 cm	907.2 kg	53.1 kg	8" Polyolefin	1

A-FRAME PANEL TRUCKS

No.	Color	Description	U.S. Dimensions	U.S. Capacity	U.S. Ship Wt/Ctn	Metric Dimensions	Metric Capacity	Metric Ship Wt/Ctn	Caster Type	Pack
FG446200	BLA	A-Frame Panel Truck (24" x 36")	35.9" l x 24.25" w x 43" h	2,000 lb	73.0 lb	91.2 cm x 61.6 cm x 109.2 cm	907.2 kg	33.1 kg	6" Polyolefin	1
FG446300	BLA	A-Frame Panel Truck (24" x 48")	47.9" l x 24.25" w x 44.9" h	2,000 lb	87.0 lb	121.7 cm x 61.6 cm x 114 cm	907.2 kg	39.5 kg	8" Polyolefin	1
FG446400	BLA	A-Frame Panel Truck (30" x 60")	59.9" l x 30.25" w x 44.9" h	2,000 lb	106.0 lb	152.1 cm x 76.8 cm x 114 cm	907.2 kg	48.1 kg	8" Polyolefin	1

WHEN ORDERING PRODUCTS WITH **BOLD** COLOR CODES, PLEASE SPECIFY COLOR CODE AFTER THE PRODUCT NUMBER. REFER TO THE PRODUCT COLOR GUIDE AT THE BACK OF THE CATALOG.



Check out the items marked with this symbol for our new line of Executive Series™ products.

Work-Height Platform Trucks

Unique, adjustable design allows platform deck to be placed at one of three work heights.

DURAMOLD

DECK SIZES:

24" X 36"

24" X 48"

30" X 60"

MAX. CAPACITY (lbs)

2000

See it in ACTION

www.rcpmaterialhandling.com

CASTER DESCRIPTIONS
See "Caster Guide"



REDUCE LIFTING AND BENDING

Easily moveable platform adjusts to three work heights, helping to safeguard user well-being and improve productivity.



CHEMICAL- AND WATER-RESISTANT CASTERS

TPR casters absorb shock, and provide floor surface protection and quiet operation.



FG447300

HEIGHT ADJUSTMENT

Adjustable platform deck reduces the strain of bending and lifting. SKUs FG447300 and FG447400 (shown) adjust from 29" to 35" high in 3" increments. SKU FG447200 adjusts from 27" to 33" high in 3" increments.

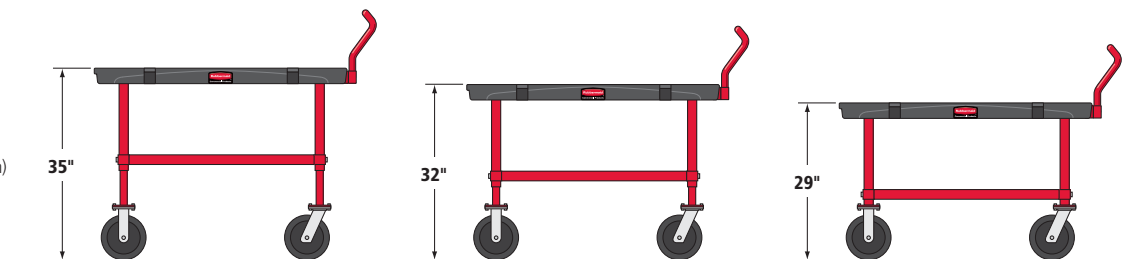

No.	Color	Description	U.S. Dimensions	U.S. Capacity	U.S. Ship Wt/Ctn	Metric Dimensions	Metric Capacity	Metric Ship Wt/Ctn	Caster Type	Pack
FG447200	BLA	Work-Height Platform Truck (24" x 36")	40.1" l x 24.25" w x 38.9" h	2,000 lb	86.0 lb	101.9 cm x 61.6 cm x 98.8 cm	907.2 kg	39 kg	6" TPR	1
FG447300	BLA	Work-Height Platform Truck (24" x 48")	52.1" l x 24.25" w x 40.9" h	2,000 lb	102.0 lb	132.3 cm x 61.6 cm x 103.9 cm	907.2 kg	46.3 kg	8" TPR	1
FG447400	BLA	Work-Height Platform Truck (30" x 60")	64.1" l x 30.25" w x 40.75" h	2,000 lb	115.0 lb	162.8 cm x 76.8 cm x 103.5 cm	907.2 kg	52.2 kg	8" TPR	1

5th Wheel Wagon Trucks

Move heavy loads across rough surfaces, indoors and out.

DURAMOLD

DECK SIZES:

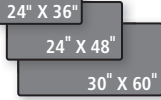

CAPACITY RANGE (lbs)
1200-2000

CASTER DESCRIPTIONS
See "Caster Guide"

WHEEL OPTIONS



MOR wheels absorb shock and provide floor surface protection and quiet operation. Excellent on linoleum, tile, terrazzo, wood, smooth concrete, and carpet.



Pneumatic wheels provide a cushioned and quiet ride for fragile loads, making them ideal for rough and uneven surfaces, inside and out. Excellent on virtually all surfaces from smooth concrete to gravel.



BETTER CONTROL

The pivoting 5th wheel design provides a tight turning radius for maximum maneuverability.

See it in ACTION
www.rcpmaterialhandling.com



MOVE LOADS SAFELY

Turn stop prevents tipping/dumping of load.

EASY TO USE

Vinyl grip handle stays upright when not in use.

KEEP LOADS SECURE

Four tie-down points, two on each side, help with load retention.

RUGGED CONSTRUCTION

Duramold's™ exclusive, precision-engineered resin and metal composite structure provides maximum load support.

TOWABLE AND TRAINABLE

- T-bar is removable for towing by a single truck up to 5 mph
- Tow Hitch Kit available (FG9T1000, sold separately) with pintle-style and clevis pin-mount tow hitches
- Rear tow hitch allows training with other trucks



T-Handle

Pintle



Clevis Pin

Rear Tow Hitch



No.	Color	Description	U.S. Dimensions	U.S. Capacity	U.S. Ship Wt/Ctn	Metric Dimensions	Metric Capacity	Metric Ship Wt/Ctn	Caster Type	Pack
FG447500	BLA	5th Wheel Wagon Truck (24" x 36")	45" l x 24.25" w x 16.75" h	1,200 lb	86.0 lb	114.3 cm x 61.6 cm x 42.5 cm	544.3 kg	39 kg	10" Pneumatic	1
FG447600	BLA	5th Wheel Wagon Truck (24" x 36")	45" l x 24.25" w x 16.5" h	2,000 lb	86.0 lb	114.3 cm x 61.6 cm x 41.9 cm	907.2 kg	39 kg	10" TPR	1
FG447700	BLA	5th Wheel Wagon Truck (24" x 48")	56.25" l x 24.25" w x 17.5" h	2,000 lb	98.0 lb	142.9 cm x 61.6 cm x 44.5 cm	907.2 kg	44.5 kg	12" Pneumatic	1
FG447800	BLA	5th Wheel Wagon Truck (24" x 48")	56.25" l x 24.25" w x 17.5" h	2,000 lb	98.0 lb	142.9 cm x 61.6 cm x 44.5 cm	907.2 kg	44.5 kg	12" TPR	1
FG447900	BLA	5th Wheel Wagon Truck (30" x 60")	70.1" l x 30.25" w x 17.5" h	2,000 lb	117.0 lb	178.1 cm x 76.8 cm x 44.5 cm	907.2 kg	53.1 kg	12" Pneumatic	1
FG448000	BLA	5th Wheel Wagon Truck (30" x 60")	70.1" l x 30.25" w x 17.5" h	2,000 lb	117.0 lb	178.1 cm x 76.8 cm x 44.5 cm	907.2 kg	53.1 kg	12" TPR	1
FG9T0600	BLA	5th Wheel Wagon Truck with 16" (40.6 cm) Pneumatic Wheels	70" l x 40" w	2,000 lb	130.0 lb	177.8 cm x 101.6 cm	907.2 kg	59 kg	16" Pneumatic	1
FG9T0700	BLA	5th Wheel Wagon Truck with 12" (30.5 cm) Pneumatic Wheels	70" l x 40" w	2,000 lb	125.0 lb	177.8 cm x 101.6 cm	907.2 kg	56.7 kg	12" TPR	1
FG9T0900	BLA	Side Panel Package, Converts Truck to Platform Convertible Wagon (4 sides and 2 end panels), fits FG9T0600, FG9T0700	N/A	N/A	55.9 lb	N/A	N/A	25.4 kg	N/A	1
FG9T1000	0000	Tow Package, fits all 5th Wheel Wagon Trucks	N/A	N/A	2.8 lb	N/A	N/A	1.3 kg	N/A	1

WHEN ORDERING PRODUCTS WITH **BOLD** COLOR CODES, PLEASE SPECIFY COLOR CODE AFTER THE PRODUCT NUMBER. REFER TO THE PRODUCT COLOR GUIDE AT THE BACK OF THE CATALOG.



Check out the items marked with this symbol for our new line of Executive Series™ products.

Side Panel Platform Trucks

Ideal for transporting small packages and materials.

DURAMOLD

DECK SIZES:

24" X 36"

24" X 48"

30" X 60"

CAPACITY RANGE (lbs)

1000-2000

See it in ACTION

www.rcpmaterialhandling.com

CASTER DESCRIPTIONS
See "Caster Guide"



CUSTOMIZABLE

Remove one, two, three, or all four side panels to accommodate any size load.

ENHANCE USER COMFORT

Side panel cutouts allow easy access to load.



BUILT-IN SAFETY FEATURES

Retainer clips prevent unintended handle removal.

RUGGED CONSTRUCTION

Duramold's™ exclusive, precision-engineered resin and metal composite structure provides maximum load support.

3" X 3" GRID SIDE PANELS

Heavy-duty wire side panels retain small packages and items.

BETTER LOAD RETENTION

Molded-in tie-down slots increase load security. Textured deck surface reduces load slippage.

No.	Color	Description	U.S. Dimensions	U.S. Capacity	U.S. Ship Wt/Ctn	Metric Dimensions	Metric Capacity	Metric Ship Wt/Ctn	Caster Type	Pack
FG448400	BLA	Side Panel Platform Truck (24" x 36")	44" l x 24.25" w x 39.25" h	1,000 lb	85.0 lb	111.8 cm x 61.6 cm x 99.7 cm	453.6 kg	38.6 kg	6" TPR	1
FG448500	BLA	Side Panel Platform Truck (24" x 36")	44" l x 24.25" w x 41.5" h	1,200 lb	105.0 lb	142.2 cm x 61.6 cm x 105.4 cm	544.3 kg	47.6 kg	8" Pneumatic	1
FG448600	BLA	Side Panel Platform Truck (24" x 48")	56" l x 24.25" w x 41.25" h	2,000 lb	105.0 lb	142.2 cm x 61.6 cm x 104.8 cm	907.2 kg	47.6 kg	8" TPR	1
FG448700	BLA	Side Panel Platform Truck (30" x 60")	68.1" l x 30.25" w x 41.4" h	1,200 lb	126.0 lb	173 cm x 76.8 cm x 105.2 cm	544.3 kg	57.2 kg	8" Pneumatic	1
FG448800	BLA	Side Panel Platform Truck (30" x 60")	68.1" l x 30.25" w x 41.4" h	2,000 lb	126.0 lb	173 cm x 76.8 cm x 105.2 cm	907.2 kg	57.2 kg	8" TPR	1

Stanchion Platform Trucks

Safely transport long, bulky loads such as roll goods, pipe, lumber, carpet, and linoleum.

DURAMOLD

DECK SIZES:

24" X 36"

24" X 48"

30" X 60"

MAX. CAPACITY (lbs)

2500

CASTER DESCRIPTIONS
See "Caster Guide"

See it in ACTION
www.rcpmaterialhandling.com



EASY LOADING AND UNLOADING

Removable heavy-duty steel corner posts allow access to load. Corner post retainer clips prevent unintended removal.

FG448200

PROTECT FLOORS

Hard-tread polyolefin casters roll easier than soft tread casters. Nonmarking, impact and chemical resistant casters won't flat-spot under static loads or pick up metal shavings, nails, and other debris. Excellent on concrete, wood, carpet, and steel surfaces.

KEEP LOADS SECURE

Four molded-in tie-down points provide additional load security.

REDUCE LOAD SLIPPAGE

Textured deck surface reduces load slippage.

RUGGED CONSTRUCTION

Duramold's™ exclusive, precision-engineered resin and metal composite structure provides maximum load support.

No.	Color	Description	U.S. Dimensions	U.S. Capacity	U.S. Ship Wt/Ctn	Metric Dimensions	Metric Capacity	Metric Ship Wt/Ctn	Caster Type	Pack
FG448100	BLA	Stanchion Platform Truck (24" x 36")	35.9" l x 24.25" w x 38.9" h	2,500 lb	67.0 lb	91.2 cm x 61.6 cm x 98.8 cm	1,134 kg	30.4 kg	6" Polyolefin	1
FG448200	BLA	Stanchion Platform Truck (24" x 48")	47.88" l x 24.25" w x 42.5" h	2,500 lb	78.0 lb	121.6 cm x 61.6 cm x 108 cm	1,134 kg	35.4 kg	8" Polyolefin	1
FG448300	BLA	Stanchion Platform Truck (30" x 60")	59.9" l x 30.25" w x 42.5" h	2,500 lb	92.0 lb	152.1 cm x 76.8 cm x 108 cm	1,134 kg	41.7 kg	8" Polyolefin	1

WHEN ORDERING PRODUCTS WITH **BOLD** COLOR CODES, PLEASE SPECIFY COLOR CODE AFTER THE PRODUCT NUMBER. REFER TO THE PRODUCT COLOR GUIDE AT THE BACK OF THE CATALOG.



Check out the items marked with this symbol for our new line of Executive Series™ products.

Semi-Live Skids

Ideal for temporary transport and storage of materials and supplies.

DURAMOLD

DECK SIZES:

24" X 36"

24" X 48"

30" X 60"

CAPACITY RANGE (lbs)

1500-2000

CASTER DESCRIPTIONS
See "Caster Guide"

See it in ACTION

www.rcpmaterialhandling.com

REMOVABLE JACK HANDLE

Provides tight turning radius for easy maneuverability in confined spaces (Jack Handle sold separately).

BETTER LOAD RETENTION

Molded-in tie-down slots increase load security. Textured deck surface reduces load slippage.

RUGGED CONSTRUCTION

Duramold's™ exclusive, precision-engineered resin and metal composite structure provides maximum load support.



FG449400



No.	Color	Description	U.S. Dimensions	U.S. Capacity	U.S. Ship Wt/Ctn	Metric Dimensions	Metric Capacity	Metric Ship Wt/Ctn	Caster Type	Pack
FG449300	BLA	Semi-Live Skid (24" x 36")	35.9" l x 25.25" w x 12.5" h	2,000 lb	42.0 lb	91.2 cm x 64.1 cm x 31.8 cm	907.2 kg	19.1 kg	8" x 2" TPR	1
FG449400	BLA	Semi-Live Skid (24" x 48")	47.9" l x 25.25" w x 12.5" h	2,000 lb	51.0 lb	121.7 cm x 64.1 cm x 31.8 cm	907.2 kg	23.1 kg	8" x 2" TPR	1
FG449500	BLA	Semi-Live Skid (30" x 60")	59.9" l x 30.25" w x 12.5" h	2,000 lb	64.0 lb	152.1 cm x 76.8 cm x 31.8 cm	907.2 kg	29 kg	8" x 2" TPR	1
FG449200	RED	Semi-Live Skid Jack Handle	49.9" l x 11.75" w x 10.25" h	N/A	38.0 lb	126.7 cm x 29.8 cm x 26 cm	N/A	17.2 kg	8" x 2" TPR	1

Dunnage Racks

Perfect for storing frozen, cold, or dry goods off of the floor.

NSF

MEETS NSF FOOD SAFETY GUIDELINES

12" high deck meets food safety guidelines; NSF approved.

FREEZER-SAFE

Withstands temperatures from -20° to 120°F.



HELPS ENSURE PRODUCT QUALITY

Slotted deck allows maximum air circulation for perishable or dry goods.



FG449100

RUGGED CONSTRUCTION

Duramold's™ exclusive, precision-engineered resin and metal composite structure provides maximum load support.



No.	Color	Description	U.S. Dimensions	U.S. Capacity	U.S. Ship Wt/Ctn	Metric Dimensions	Metric Capacity	Metric Ship Wt/Ctn	Pack
FG448900	BLA	Dunnage Rack (24" x 36")	35.9" l x 24.25" w x 12.5" h	1,500 lb	28.0 lb	91.2 cm x 61.6 cm x 31.8 cm	680.4 kg	12.7 kg	1
FG449000	BLA	Dunnage Rack (24" x 48")	47.88" l x 24.25" w x 12.5" h	2,000 lb	35.0 lb	121.6 cm x 61.6 cm x 31.8 cm	907.2 kg	15.9 kg	1
FG449100	BLA	Dunnage Rack (30" x 60")	59.9" l x 30.25" w x 12.5" h	2,000 lb	44.0 lb	152.1 cm x 76.8 cm x 31.8 cm	907.2 kg	20.0 kg	1

StockMate® Restocking Trucks

A complete system to transport cartons, stock shelves, manage cardboard, and address aisle safety.

- Ideal for stocking shelves and picking inventory
- Steel reinforced molded structural foam decks won't rust, dent, or require painting
- BoxMate™ Cardboard Management System helps keep aisles clear
- Dry erase identification placard and work surface available on some models
- Up to 1,800-lb load capacity
- Hinged Deck model (FG9T4500) easily converts from full-size to half-size truck
- Wide range of accessories to enhance productivity and safety
- Optional Refuse Bin (FG335388)



FG9T4500 / FG9T4800 / FG335388



FG9T4800 Wire Shelf

Provides additional surface to help organize and transport smaller cartons.



FG9T4500



FG9T5200 / FG335388



FG9T5600

No.	Color	Description	U.S. Dimensions	U.S. Capacity	U.S. Ship Wt/Ctn	Metric Dimensions	Metric Capacity	Metric Ship Wt/Ctn	Pack
FG9T4500	BLA	StockMate® ES Restocking Truck with Hinged Deck	63" l x 19.25" w x 19.25" h	1,800 lb	75.1 lb	160 cm x 48.9 cm x 48.9 cm	816.5 kg	34.1 kg	1
FG9T5000	BLA	StockMate® Restocking Truck, Standard Deck	63" l x 19.13" w x 33.63" h	1,800 lb	75.1 lb	160 cm x 48.6 cm x 85.4 cm	816.5 kg	34.1 kg	1
FG9T5200	BLA	StockMate® Restocking Truck, Standard Deck with Cardboard Management System, Polyurethane Wheels and Casters	63" l x 18" w x 64.25" h	1,800 lb	84.9 lb	160 cm x 45.7 cm x 163.2 cm	816.5 kg	38.5 kg	1
FG9T5600	BLA	StockMate® Restocking Truck, Utility Deck, Olefin Wheels and Casters	63" l x 18" w x 64.25" h	1,500 lb	84.9 lb	160 cm x 45.7 cm x 163.2 cm	680.4 kg	38.5 kg	1
FG9T4800	BLA	StockMate® Wire Shelf	64" l x 15" w x 3" h	N/A	4.3 lb	162.6 cm x 38.1 cm x 7.6 cm	N/A	2 kg	1

Triple® Trolley

Efficiently transports large, bulky loads, then folds flat for easy storage.

- Sturdy structural foam deck won't rust, dent, chip, or peel
- Nonskid platform surface helps prevent load shifting
- Three-position handle lets users push, pull, or fold flat for use as a dolly
- Casters are nonmarking



Three-position handle provides better mobility and convenient storage.



FG440000

No.	Color	Description	U.S. Dimensions	U.S. Capacity	U.S. Ship Wt/Ctn	Metric Dimensions	Metric Capacity	Metric Ship Wt/Ctn	Pack
FG440000	BLA	Triple® Trolley, Utility-Duty with Straight Handle and 3" (7.6 cm) Casters	32.5" l x 20.5" w	250 lb	20.6 lb	82.6 cm x 52.1 cm	113.4 kg	9.3 kg	1
FG440100	BLA	Triple® Trolley, Standard Duty with User-Friendly Handle and 5" dia x .875" w (12.7 cm x 2.22 cm) Casters	32.5" l x 20.5" w	500 lb	25.4 lb	82.6 cm x 52.1 cm	226.8 kg	11.5 kg	1

Heavy-Duty Dollies

Steel-reinforced, molded dollies perform a wide variety of moving tasks.

- Durable, one-piece molded polyethylene decks are lightweight and easy to clean
- Sturdy plastic construction won't rot, mildew, warp, rust, or splinter
- Easy-rolling, 4" nonmarking swivel casters
- FG9T5500 features 1" thick rubber pads to protect load and minimize slippage



FG9T5500

FG9T5400

No.	Color	Description	U.S. Dimensions	U.S. Capacity	U.S. Ship Wt/Ctn	Metric Dimensions	Metric Capacity	Metric Ship Wt/Ctn	Pack
FG9T5400	RED	Polyethylene Dolly, Flush Deck	30" l x 18" w	1,000 lb	19.7 lb	76.2 cm x 45.7 cm	453.6 kg	8.9 kg	1
FG9T5500	RED	Polyethylene Dolly, Padded Deck	30" l x 18" w	1,000 lb	23.7 lb	76.2 cm x 45.7 cm	453.6 kg	10.8 kg	1

WHEN ORDERING PRODUCTS WITH BOLD COLOR CODES, PLEASE SPECIFY COLOR CODE AFTER THE PRODUCT NUMBER. REFER TO THE PRODUCT COLOR GUIDE AT THE BACK OF THE CATALOG.



Check out the items marked with this symbol for our new line of Executive Series™ products.

TradeMaster® Mobile Cabinets and Work Centers

Easily transport tools and supplies where you need them.

- Features locking cabinet doors and 4" deep drawers for versatile tool and supply storage and organization
- Drawers feature commercial-quality, ball-bearing slides
- Metal-reinforced structural foam shelves engineered for durability
- Arrives 90% assembled



CART ACCESSORIES
See "Cart Accessories"

See it in ACTION

www.rubbermaidtrademaster.com



No.	Color	Description	U.S. Dimensions	U.S. Capacity	U.S. Ship Wt/Ctn	Metric Dimensions	Metric Capacity	Metric Ship Wt/Ctn	Pack
FG451288	BLA	TradeMaster® Cart with 2-Door Cabinet, Small	41.63" l x 18.25" w x 38.38" h	500 lb	57.1 lb	105.7 cm x 46.4 cm x 97.5 cm	226.8 kg	25.9 kg	1
FG451388	BLA	TradeMaster® Cart with 4 Drawers	40.63" l x 18.38" w x 33.38" h	500 lb	86.9 lb	103.2 cm x 46.7 cm x 84.8 cm	226.8 kg	39.4 kg	1
FG453288	BLA	TradeMaster® Cart with 2-Door Cabinet, Large	49" l x 26.25" w x 38.25" h	750 lb	83.8 lb	124.5 cm x 66.7 cm x 97.2 cm	340.2 kg	38 kg	1
FG453388	BLA	TradeMaster® Cart with 4 Drawers and Cabinet, Small	49" l x 26.25" w x 38" h	750 lb	123.0 lb	124.5 cm x 66.7 cm x 96.5 cm	340.2 kg	55.8 kg	1
FG453588	BLA	TradeMaster® Professional Contractors' Cart	52.5" l x 38.63" w x 37.88" h	500 lb	84.7 lb	133.4 cm x 98.1 cm x 96.2 cm	226.8 kg	38.4 kg	1
FG454888	BLA	TradeMaster® Cart with 4 Drawers and Cabinet, Large	58.63" l x 26.38" w x 33.25" h	750 lb	126.5 lb	148.9 cm x 67 cm x 84.5 cm	340.2 kg	57.4 kg	1

Trades Carts

Moves productivity right to the work site—a complete tool storage and mobile workbench system.

- Four compartmentalized boxes for storing assorted parts and hardware
- Fully enclosed, lockable storage compartment helps keep tools and materials secure (FG618088)
- Two storage bins hold essential hand tools and supplies
- Carts move easily over hard surfaces and through elevators and doorways
- Flat surface at user-friendly height provides convenient work area
- Nonmarking, 5" casters for easy mobility
- Optional Refuse Bin (FG335388) and Utility Bin (FG335488)



CART ACCESSORIES
See "Cart Accessories"



FG618000



FG618088



Convenient lockable cabinet.



Four compartment drawers for assorted parts.

No.	Color	Description	U.S. Dimensions	U.S. Capacity	U.S. Ship Wt/Ctn	Metric Dimensions	Metric Capacity	Metric Ship Wt/Ctn	Pack
FG618000	BLA	Trades Cart with 5" (12.7 cm) Casters includes 2 parts boxes and 4 parts bins	38" l x 19.25" w x 33.38" h	180 lb top shelf, 150 lb bottom shelf	50.3 lb	96.5 cm x 48.9 cm x 84.8 cm	81.6 kg top shelf, 68 kg bottom shelf	22.8 kg	1
FG618088	BLA	Trades Cart with Locking Cabinet includes 2 parts boxes and 4 parts bins	38" l x 19.25" w x 33.38" h	180 lb top shelf, 150 lb bottom shelf	68.0 lb	96.5 cm x 48.9 cm x 84.8 cm	81.6 kg top shelf, 68 kg bottom shelf	30.8 kg	1

5-Drawer Mobile Work Center

Heavy-duty work surface supports up to 250 lbs.

- Built-in cord wrap provides neat, convenient storage of power tools and work lights
- Casters allow easy maneuverability and are lockable for safety
- Locking bar provides security and keeps drawers from sliding open during transport
- Pegboard side panels provide convenient tool organization



FG773488



No.	Color	Description	U.S. Dimensions	U.S. Capacity	U.S. Ship Wt/Ctn	Metric Dimensions	Metric Capacity	Metric Ship Wt/Ctn	Pack
FG773488	BLA	5-Drawer Mobile Work Center	32.63" l x 19.9" w x 33.5" h	250 lb	69.0 lb	82.9 cm x 50.5 cm x 85.1 cm	113.4 kg	31.3 kg	1

WHEN ORDERING PRODUCTS WITH **BOLD** COLOR CODES, PLEASE SPECIFY COLOR CODE AFTER THE PRODUCT NUMBER. REFER TO THE PRODUCT COLOR GUIDE AT THE BACK OF THE CATALOG.



Check out the items marked with this symbol for our new line of Executive Series™ products.

Ladder Cart

Provides greater mobility, enhanced access, safe ladder handling, and minimal storage requirements.

- Carries a 6' ladder through standard doorways, down halls, and into elevators
- Commercial-grade hybrid construction of powder-coated steel and structural foam holds up to 500 lbs
- Tall profile for a more comfortable work height
- Easily adaptable to work site requirements, including long-item storage, tool holders, and locking cabinets



See it in ACTION
www.rubbermaidladdercart.com



FASTENER CADDY
 Empty caddy can be flipped over to create a level work surface.



LOCKING STRAP
 Secure ladders with a simple snap.



TOOL HOLDER
 Keeps small tools handy.

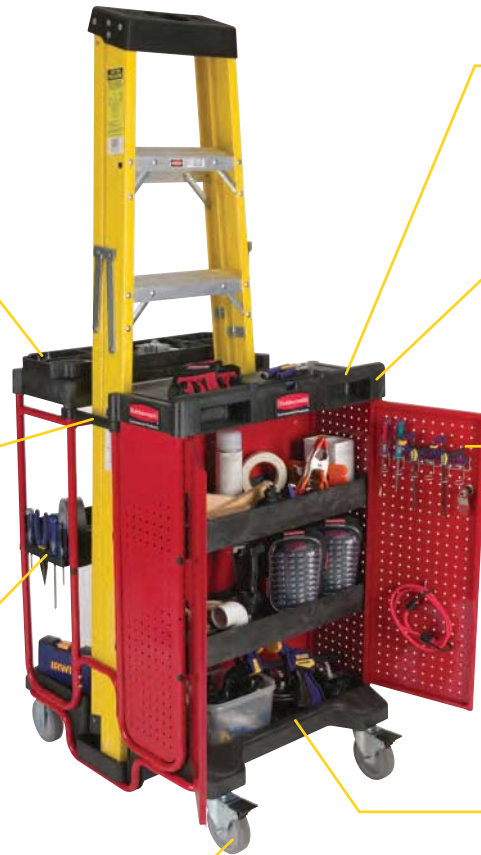

CONDUIT/PIPE HOLDER
 Molded handle holds pipe or conduit for clamping and trimming.

DURABLE STRUCTURAL FOAM CONSTRUCTION

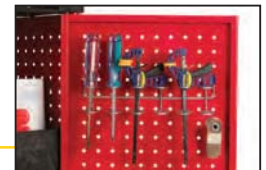

PERFORATED DOOR AND SIDE PANELS
 Accommodate 1/4" tool hooks on 1" centers.



CONVERTIBLE TO TRANSPORT/CHANGE FLUORESCENT LIGHTBULBS

STANDARD 5" LOCKING CASTERS
 Can be fitted with FG459200 Pneumatic Casters (sold separately).



FG9T5700
Ladder Cart



FG9T5800
Ladder Cart with Cabinet

COMPACT AND MANEUVERABLE

Small footprint with unique recessed central ladder storage improves cornering and stability. The 42" working height means less bending down and easier handling. Efficient size for closet storage.



Smaller Turning Radius

No.	Color	Description	U.S. Dimensions	U.S. Capacity	U.S. Ship Wt/Ctn	Metric Dimensions	Metric Capacity	Metric Ship Wt/Ctn	Pack
FG9T5700	BLA	Ladder Cart	31.5" l x 27" w x 42" h	500 lb	69.0 lb	80 cm x 68.6 cm x 106.7 cm	226.8 kg	31.3 kg	1
FG9T5800	BLA	Ladder Cart with Cabinet	31.5" l x 27" w x 42" h	500 lb	99.0 lb	80 cm x 68.6 cm x 106.7 cm	226.8 kg	44.9 kg	1
FG459200	0000	8" (20.3 cm) Pneumatic Caster Kit	56.88" l x 19.2" w x 33.3" h	N/A	25.6 lb	144.5 cm x 48.8 cm x 84.6 cm	N/A	11.6 kg	1

Heavy-Duty Utility Carts

Transport materials, supplies, and heavy loads securely in almost any environment.



- Available in pocket-shelf or flat-shelf models
- Variable grip-height handle improves control and worker safety
- Executive Series™ version features Quiet Casters

Pocket-shelf models feature:

- Integrated V-notch to hold pipe and conduit securely for safe cutting
- Deep pocket shelves to keep loads secure

Flat-shelf models feature:

- Large, flat top shelf for oversize loads and smarter work surface
- Lower pocket shelf to keep loads secure



STAY ORGANIZED

Easy-reach tool/accessory hooks provide additional storage.



WORK MORE EFFICIENTLY

Built-in tool holster and caddy keep items at hand and in place during transport.



CUSTOMIZABLE

Molded-in fittings allow you to add pipe or rods to hold wire spools and other roll-type goods.



CASTER OPTIONS ARE AVAILABLE ON MEDIUM AND LARGE CARTS



Pneumatic casters provide a cushioned and quiet ride for fragile loads, making them ideal for rough and uneven surfaces, inside and out. Excellent on virtually all surfaces from smooth concrete to gravel.



TPR casters absorb shock and provide floor surface protection and quiet operation. Excellent on linoleum, tile, terrazzo, wood, smooth concrete, and carpet.

CART SIZES:

- 17 1/8" X 38 1/2"
- 25 1/4" X 44"
- 25 1/4" X 54"

CAPACITY RANGE (lbs)
500-750

WHEN ORDERING PRODUCTS WITH **BOLD** COLOR CODES, PLEASE SPECIFY COLOR CODE AFTER THE PRODUCT NUMBER. REFER TO THE PRODUCT COLOR GUIDE AT THE BACK OF THE CATALOG.



Check out the items marked with this symbol for our new line of Executive Series™ products.



LIPPED-SHELF CARTS

No.	Color	Description	U.S. Dimensions	U.S. Capacity	U.S. Ship Wt/Ctn	Metric Dimensions	Metric Capacity	Metric Ship Wt/Ctn	Caster Type	Pack
FG450088	BLA, BEIG	Utility Cart	39" l x 17.88" w x 33.25" h	500 lb	30.8 lb	99.1 cm x 45.4 cm x 84.5 cm	226.8 kg	14 kg	5" TPR	1
FG452088	BLA, BEIG	Utility Cart	44" l x 25.25" w x 39" h	500 lb	42.8 lb	111.8 cm x 64.1 cm x 99.1 cm	226.8 kg	19.4 kg	5" TPR	1
1867535	BLACK	Executive Series™ Utility Cart w/ 5" Quiet Casters	36" l x 24" w x 32.25" h	500 lb	42.8 lb	91.4 cm x 61 cm x 81.9 cm	226.8 kg	19.4 kg	5" Quiet	1
FG452010	BLA, BEIG	HD 2-Shelf Utility Cart w/ Lipped Shelf (Med) with Pneumatic Casters	45.25" l x 25.88" w x 37.12" h	500 lb	63.0 lb	114.9 cm x 65.7 cm x 94.3 cm	226.8 kg	28.6 kg	8" Pneumatic	1
FG454600	BLA, BEIG	HD 2-Shelf Utility Cart w/ Lipped Shelf (Large)	55" l x 26" w x 33.25" h	750 lb	52.4 lb	139.7 cm x 66 cm x 84.5 cm	340.2 kg	23.8 kg	5" TPR	1
FG454610	BLA, BEIG	HD 2-Shelf Utility Cart w/ Lipped Shelf (Large) with Pneumatic Casters	55" l x 26" w x 33.25" h	750 lb	71.0 lb	139.7 cm x 66 cm x 84.5 cm	340.2 kg	32.2 kg	8" Pneumatic	1
FG450089	BLA, BEIG	Utility Cart	39" l x 17.88" w x 33.25" h	500 lb	31.1 lb	99.1 cm x 45.4 cm x 84.5 cm	226.8 kg	14.1 kg	5" TPR	1
FG452089	BLA, BEIG	Utility Cart	45.25" l x 25.88" w x 33.25" h	500 lb	44.7 lb	114.9 cm x 65.7 cm x 84.5 cm	226.8 kg	20.3 kg	5" TPR	1
FG9T6600*	BLA	2 Shelf Utility Cart, 5" Casters	40.25" l x 25.63" w x 32.5" h	500 lb	30.8 lb	102.2 cm x 65.1 x 99.1 cm	226.8 kg	14.0 kg	5" (12.7 cm)	12
FG9T6700*	BLA	2 Shelf Utility Cart, 5" Casters	34.25" l x 17.375" w x 31.5" h	500 lb	42.8 lb	80 cm x 68.6 cm x 106.7 cm	226.8 kg	19.4 kg	5" (12.7 cm)	10

*Pallet Pack

FLAT-SHELF CARTS

No.	Color	Description	U.S. Dimensions	U.S. Capacity	U.S. Ship Wt/Ctn	Metric Dimensions	Metric Capacity	Metric Ship Wt/Ctn	Caster Type	Pack
FG450500	BLA, BEIG	HD 2-Shelf Utility Cart Flat Shelf (Small)	37.88" l x 19.2" w x 33.3" h	500 lb	29.5 lb	96.2 cm x 48.8 cm x 84.6 cm	226.8 kg	13.4 kg	5" TPR	1
FG452500	BLA, BEIG	HD 2-Shelf Utility Cart Flat Shelf (Med)	43.88" l x 25.88" w x 33.3" h	500 lb	41.0 lb	111.5 cm x 65.7 cm x 84.6 cm	226.8 kg	18.6 kg	5" TPR	1
FG454500	BLA, BEIG	HD 2-Shelf Utility Cart Flat Shelf (Large)	54" l x 25.25" w x 36" h	750 lb	52.4 lb	137.2 cm x 64.1 cm x 91.4 cm	340.2 kg	23.8 kg	5" TPR	1
FG450589	BLA, BEIG	HD 2-Shelf Utility Cart Flat Shelf (Small)	37.88" l x 19.2" w x 33.3" h	500 lb	29.5 lb	96.2 cm x 48.8 cm x 84.6 cm	226.8 kg	13.4 kg	5" TPR	1
FG452589	BLA, BEIG	HD 2-Shelf Utility Cart Flat Shelf (Med)	43.88" l x 25.88" w x 33.3" h	500 lb	41.0 lb	111.5 cm x 65.7 cm x 84.6 cm	226.8 kg	18.6 kg	5" TPR	1

ACCESSORIZE AND CUSTOMIZE FOR YOUR NEEDS



FG459000 3-OUTLET POWER STRIP



FG335388 8-GALLON REFUSE BIN



FG459300 SINGLE FULL EXTENSION DRAWER (see Cart Accessories)

Convertible Utility Cart

Converts from a utility cart to a platform truck in just seconds.

- Innovative design
- Multifunctional productivity with improved worker well-being—saving you time and money



PUSH BUTTONS

Depress buttons to easily convert from utility cart to platform truck.



LOCKING CASTERS

Rear wheel locks keep cart safely in place while loading and unloading.



FOOT PEDAL

Depress foot pedal to fold cart for storage.



QUICK CONVERSION

Easily converts from a utility cart to a platform truck and then folds flat for storage.

FOLDS FROM 34 3/8" TO 10 7/8" FOR EASY STORAGE



UTILITY CART

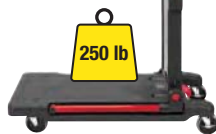

PLATFORM TRUCK



34 3/8" High

10 7/8" High

No.	Color	Description	U.S. Dimensions	U.S. Capacity	U.S. Ship Wt/Ctn	Metric Dimensions	Metric Capacity	Metric Ship Wt/Ctn	Pack
FG430000	BLA	Convertible Utility Cart	45.2" l x 23.8" w x 34.4" h (Utility)	400 lb	52.0 lb	115 cm x 60.5 cm x 87.4 cm (Utility)	181 kg	23.6 kg	1

WHEN ORDERING PRODUCTS WITH **BOLD** COLOR CODES, PLEASE SPECIFY COLOR CODE AFTER THE PRODUCT NUMBER. REFER TO THE PRODUCT COLOR GUIDE AT THE BACK OF THE CATALOG.



Check out the items marked with this symbol for our new line of Executive Series™ products.

Executive Service Cart

The Executive Service Cart is an elegant and versatile solution for back- and front-of-house tasks. With 20% more top-shelf capacity, it's constructed of durable, recyclable polyethylene and it's easy to clean—keeping your business looking smart for years.



ERGONOMIC ROUNDED HANDLES

Improves maneuverability and comfort.

WRAPAROUND END PANELS

Conceals cart contents.

SOLID ROUNDED BUMPER

Gentle on walls and furniture.



300-LB LOAD CAPACITY

Holds 100 lbs per shelf.



FG9T6800



FG9T6800

ATTRACTIVE STYLING

Ideal for front-of-house use.



INCREASED CAPACITY

Accommodates two standard bus boxes on top shelf.

No.	Color	Description	Dimensions	US Capacity	US Ship Wt.	Metric Dimensions	Metric Capacity	Metric Ship Wt/Ctn	Pack
New! ⑤ FG9T6800	BLA, PLAT	Executive Service Cart	39" l x 21" w x 38" h	300 lbs	31.5 lb	99.1 cm x 53.3 cm x 96.5 cm	136 kg	14.3 kg	1

ACCESSORIES

No.	Color	Description	Dimensions	US Capacity	US Ship Wt.	Metric Dimensions	Metric Capacity	Metric Ship Wt/Ctn	Pack
FG335388	BLA	Refuse Bin	12" l x 17" w x 22" h	8 gal	9.0 lb	30.5 cm x 43.2 cm x 55.9 cm	30.3 L	4.1 kg	2
FG335488	BLA	Utility Bin	12.13" l x 17" w x 10.5" h	4 gal	5.4 lb	30.8 cm x 43.2 cm x 26.7 cm	15.1 L	2.4 kg	2
FG334900*	WHT, GRAY	Bus/Utility Box	20" l x 15" w x 5" h	4.625 gal	20.6 lb	50.8 cm x 38.1 cm x 12.7 cm	17.5 L	9.3 kg	12

*Certified to NSF Standard #2 for food contact.

Service Carts

Versatile, durable carts perform a wide variety of tasks.

- Molded shelves won't rust, dent, or require painting
- Plastic construction is easy to clean and minimizes noise
- Convenient handles and compact size enhance maneuverability
- Assists in complying with HACCP guidelines
- Nonmarking swivel casters reduce touch-up cleaning



FG345700 Utility Cart includes lockable doors and sliding drawer.

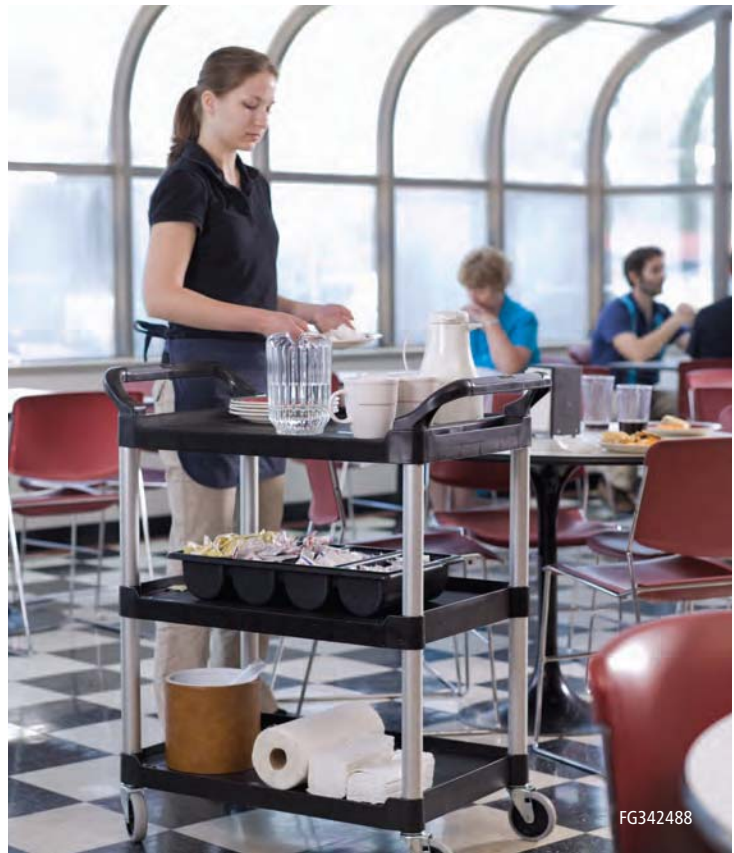

FG342488

Stylish utility cart with metal uprights and large 4" casters holds up to 200 lb (90.7 kg).



FG9T6571



FG342100



FG345700



FG335588

No.	Color	Description	U.S. Dimensions	U.S. Capacity	U.S. Ship Wt/Ctn	Metric Dimensions	Metric Capacity	Metric Ship Wt/Ctn	Pack
FG9T6571 ^a	BEIG	Utility Cart with 3" dia (7.6 cm) Swivel Casters	31.5" l x 16.25" w x 36" h	100 lb	212.0 lb	80 cm x 41.3 cm x 91.4 cm	45.3 kg	96.2 kg	6
FG342100	PLAT, BLA	Utility Cart with 3" dia (7.6 cm) Swivel Casters and End Panels	33.63" l x 18.63" w x 36.63" h	150 lb	34.0 lb	85.4 cm x 47.3 cm x 93 cm	68.0 kg	15.4 kg	1
FG342488	RED, PLAT, OWHT, BLA	Utility Cart with 4" dia (10.2 cm) Swivel Casters	33.63" l x 18.63" w x 37.75" h	200 lb	30.0 lb	85.4 cm x 47.3 cm x 95.9 cm	90.7 kg	13.6 kg	1
FG345700	BLA	Utility Cart with Lockable Doors, Sliding Drawer, and 4" dia (10.2 cm) Swivel Casters	33.63" l x 18.63" w x 37.75" h	200 lb	44.8 lb	85.4 cm x 47.3 cm x 95.9 cm	90.7 kg	20.3 kg	1
FG335588	PLAT	Utility Cart with Enclosed End Panels	31" l x 18" w x 37.5" h	300 lb	37.5 lb	78.7 cm x 45.7 cm x 95.3 cm	136.1 kg	17.0 kg	1

^aPallet Pack

WHEN ORDERING PRODUCTS WITH **BOLD** COLOR CODES, PLEASE SPECIFY COLOR CODE AFTER THE PRODUCT NUMBER. REFER TO THE PRODUCT COLOR GUIDE AT THE BACK OF THE CATALOG.



Check out the items marked with this symbol for our new line of Executive Series™ products.

Xtra™ Carts

Durable and attractive carts storage and transportation for front- and back-of-house applications.

- Metal uprights and molded shelves engineered for durability and appearance
- Nonmarking 4" swivel casters
- Wide shelves hold a variety of equipment and supplies, up to 300 lbs
- Available with locking doors and enclosure panels
- Accessories include refuse and utility bins (see page 229)



CART ACCESSORIES
See "Cart Accessories"



FG409400

Antistatic design for use with sensitive electronics.

Rubbermaid
Medical Solutions

Check out
RubbermaidMedical.com
for other healthcare carts!



FG409100



FG409200



FG409300



FG409400



FG409500



FG409600

No.	Color	Description	U.S. Dimensions	U.S. Capacity	U.S. Ship Wt/Ctn	Metric Dimensions	Metric Capacity	Metric Ship Wt/Ctn	Pack
FG409100	OWHT, GRAY, BLA	Utility Cart, Open-Sided	40.63" l x 20" w x 37.8" h	300 lb	43.4 lb	103.2 cm x 50.8 cm x 96 cm	136.1 kg	19.7 kg	1
FG409200	OWHT	Utility Cart with Enclosed End Panels on 2 Sides	40.63" l x 20" w x 37.8" h	300 lb	45.8 lb	103.2 cm x 50.8 cm x 96 cm	136.1 kg	20.8 kg	1
FG409300	OWHT, BLA	Utility Cart with Enclosed End Panels on 3 Sides	40.63" l x 20" w x 37.8" h	300 lb	51.6 lb	103.2 cm x 50.8 cm x 96 cm	136.1 kg	23.4 kg	1
FG409400	GRAY	Instrument Cart with Lockable Doors and Sliding Drawers	40.63" l x 20" w x 37.8" h	300 lb	52.0 lb	103.2 cm x 50.8 cm x 96 cm	136.1 kg	23.6 kg	1
FG409500	BLA	Equipment Cart	40.63" l x 20.75" w x 37.8" h	300 lb	58.5 lb	103.2 cm x 52.7 cm x 96 cm	136.1 kg	26.5 kg	1
FG409600	BLA	4-Shelf Cart, Open-Sided	40.63" l x 20" w x 51" h	300 lb	52.0 lb	103.2 cm x 50.8 cm x 129.5 cm	136.1 kg	23.6 kg	1

Shelving Systems

Store, organize, and transport in style with these durable and attractive shelving units.



- Stationary shelves feature molded feet for added stability
- Mobile shelf trucks come with 4" swivel nonmarking casters (two with brakes)
- Units are available with four, five, or six shelves and a variety of heights up to 72"
- Cabinet Kit with locking doors is available for several models
- Shelves feature metal uprights and steel-reinforced molded shelves



FG9T3600



FG9T3700



FG9T4300

No.	Color	Description	U.S. Dimensions	U.S. Capacity	U.S. Ship Wt/Ctn	Metric Dimensions	Metric Capacity	Metric Ship Wt/Ctn	Pack
FG9T3600	BLA	Shelving, 4-Shelf Unit	35.13" l x 20" w x 45.88" h	800 lb	53.7 lb	89.2 cm x 50.8 cm x 116.5 cm	362.9 kg	24.4 kg	1
FG9T3700	BLA	Shelving, 5-Shelf Unit	35.13" l x 20" w x 60" h	800 lb	66.8 lb	89.2 cm x 50.8 cm x 152.4 cm	362.9 kg	30.3 kg	1
FG9T3800	BLA	Shelving, 4-Shelf Unit	35.13" l x 20" w x 71.38" h	800 lb	58.7 lb	89.2 cm x 50.8 cm x 181.3 cm	362.9 kg	26.6 kg	1
FG9T3900	BLA	Shelving, 5-Shelf Unit	35.13" l x 20" w x 71.38" h	800 lb	69.1 lb	89.2 cm x 50.8 cm x 181.3 cm	362.9 kg	31.3 kg	1
FG9T4000	BLA	Shelving, 6-Shelf Unit	35.13" l x 20" w x 72.75" h	800 lb	80.8 lb	89.2 cm x 50.8 cm x 184.8 cm	362.9 kg	36.7 kg	1
FG9T4200	BLA	Mobile Shelf Truck, 5-Shelf Mobile Truck with 5" dia (12.7 cm) Casters, 2 with Locks	35.13" l x 20" w x 62.38" h	800 lb	67.0 lb	89.2 cm x 50.8 cm x 158.4 cm	362.9 kg	30.4 kg	1
FG9T4300	BLA	Mobile Shelf Truck, 4-Shelf Mobile Truck with 5" dia (12.7 cm) Casters, 2 with Locks	35.13" l x 20" w x 72.13" h	800 lb	59.2 lb	89.2 cm x 50.8 cm x 183.2 cm	362.9 kg	26.9 kg	1

Media Master® Audio-Visual Carts

Audio-Visual carts in a variety of sizes and configurations to handle any presentation need.



- Available in 33", 42", and 48" heights
- Cord wrap helps organize wires and cords
- User-friendly handle and four swivel casters for easy maneuverability
- Built-in, 3-outlet, surge-suppressing power strip (UL/CSA listed) with 10-ft cord
- Durable and attractive molded shelves and metal uprights
- Optional locking cabinet sliding drawer provides extra security



FG9T3300



FG9T2800



FG9T2900

No.	Color	Description	U.S. Dimensions	U.S. Capacity	U.S. Ship Wt/Ctn	Metric Dimensions	Metric Capacity	Metric Ship Wt/Ctn	Max TV Size	Pack
FG9T2800*	BLA	Audio-Visual Cart, Open Cart with 3 Shelves, 3" dia (7.6 cm) Casters	32.5" l x 18.63" w x 32.13" h	150 lb	30.1 lb	82.6 cm x 47.3 cm x 81.6 cm	68 kg	13.7 kg	24" diagonal 61 cm diagonal	1
FG9T2900*	BLA	Audio-Visual Cart, 3 Shelves with Cabinet, 3" dia (7.6 cm) Casters	32.5" l x 18.63" w x 32.13" h	150 lb	35.9 lb	82.6 cm x 47.3 cm x 81.6 cm	68 kg	16.3 kg	24" diagonal 61 cm diagonal	1
FG9T3000*	BLA	Audio-Visual Cart, Open Cart with 3 Shelves, 4" dia (10.2 cm) Casters	32.5" l x 18.63" w x 42.38" h	200 lb	30.9 lb	82.6 cm x 47.3 cm x 107.6 cm	90.7 kg	14 kg	24" diagonal 61 cm diagonal	1
FG9T3200*	BLA	Audio-Visual Cart, 3 Shelves with Cabinet, 4" dia (10.2 cm) Casters	32.5" l x 18.63" w x 42.38" h	200 lb	36.9 lb	82.6 cm x 47.3 cm x 107.6 cm	90.7 kg	16.7 kg	24" diagonal 61 cm diagonal	1
FG9T3300*	BLA	Audio-Visual Cart, Open Cart with 3 Shelves, 4" dia (10.2 cm) Casters	36.5" l x 20" w x 48.13" h	300 lb	42.6 lb	92.7 cm x 50.8 cm x 122.3 cm	136.1 kg	19.3 kg	32" diagonal 81.3 cm diagonal	1
FG9T3400*	BLA	Audio-Visual Cart, 3 Shelves with Cabinet, 4" dia (10.2 cm) Casters	36.5" l x 20" w x 48" h	300 lb	51.1 lb	92.7 cm x 50.8 cm x 121.9 cm	136.1 kg	23.2 kg	32" diagonal 81.3 cm diagonal	1
FG9T3500*	BLA	Audio-Visual Cart, 4 Shelves with Cabinet, 4" dia (10.2 cm) Casters	36.5" l x 20" w x 48" h	300 lb	61.7 lb	92.7 cm x 50.8 cm x 121.9 cm	136.1 kg	28 kg	32" diagonal 81.3 cm diagonal	1

*UL/CSA-listed.

WHEN ORDERING PRODUCTS WITH BOLD COLOR CODES, PLEASE SPECIFY COLOR CODE AFTER THE PRODUCT NUMBER. REFER TO THE PRODUCT COLOR GUIDE AT THE BACK OF THE CATALOG.



Check out the items marked with this symbol for our new line of Executive Series™ products.

Cart Accessories



Cart No.	FG335388 8-Gal (30.3 L) Refuse Bin Ship Weight: 9 lb/4.1 kg Pack: 2 Color: B/LA U.S. List Price: 98.20 ea	FG335488 4-Gal (15.5 L) Utility Bin Ship Weight: 5.4 lb/2.4 kg Pack: 2 Color: B/LA U.S. List Price: 46.80 ea	FG459000 3-Outlet, Surge-Protected Power Strip with 10' Cord Ship Weight: 3.4 lb/1.5 kg Pack: 1 Color: B/LA U.S. List Price: 67.80 ea	FG459100 Hook Kit (Set of 4) Ship Weight: 3.3 lb/1.5 kg Pack: 1 Color: B/LA U.S. List Price: 61.40 ea	FG459200 8" Pneumatic Caster Kit Ship Weight: 25.6 lb/11.6 kg Pack: 1 Color: 0000 U.S. List Price: 414.00 ea	FG459300 Single Full-Extension Drawer Ship Weight: 13.5 lb/6.1 kg Pack: 1 Color: RED U.S. List Price: 119.50 ea	FG61900 Utility Sliding Drawer Ship Weight: 4.5 lb/2 kg Pack: 1 Color: BRN, B/LA U.S. List Price: 87.80 ea
FG335588	✓	✓					
FG342100	✓	✓					
FG342488	✓	✓					
FG345700							
FG409100	✓	✓					✓
FG409200	✓	✓					✓
FG409300	✓	✓					✓
FG409400	✓	✓					✓
FG409500	✓	✓					✓
FG409600	✓	✓					✓
FG450088	✓	✓	✓	✓	✓		
FG451288	✓	✓	✓	✓	✓		
FG451388	✓	✓	✓	✓	✓		
FG452010	✓	✓	✓	✓	✓		
FG452088	✓	✓	✓	✓	✓	✓	
FG453288	✓	✓	✓	✓	✓		
FG453388	✓	✓	✓	✓	✓		
FG454600	✓	✓	✓	✓	✓	✓	
FG454610	✓	✓	✓	✓	✓	✓	
FG454888	✓	✓	✓	✓	✓		
FG9T2800							
FG9T2900							
FG9T3000							
FG9T3200							
FG9T3300							✓
FG9T3400							✓
FG9T3500							✓
FG9T6600			✓	✓	✓		
FG9T6700			✓	✓	✓		
FG9T6800	✓	✓					



Specifically designed for controlled dumping by one person.



Versatile solutions for any environment.



Rugged construction combined with ergonomic design to get the job done.



Durable construction and large capacities to handle big loads.

WHY STRUCTURAL FOAM?

STRENGTH

Superior strength without the need for a metal frame.

DURABILITY

Seamless structures won't leak, rust, chip, dent, or peel, even under the heaviest use.

EFFICIENCY

Lighter weight means easier to operate.
Structural foam construction minimizes maintenance.



WHEN ORDERING PRODUCTS WITH **BOLD** COLOR CODES,
PLEASE SPECIFY COLOR CODE AFTER THE PRODUCT NUMBER.
REFER TO THE PRODUCT COLOR GUIDE AT THE BACK OF THE CATALOG.



Check out the items marked with this symbol for our new line of Executive Series™ products.

Structural Foam Tilt Trucks

Durable molded trucks handle heavy loads with ease.

- Durability of modern structural foam technology
- Ergonomic "steering wheel" handle for better handling
- Nonmarking casters (FG101100, FG9T1300, FG9T1500 only)
- Frameless design supports USDA Meat and Poultry Equipment Compliance
- Unibody design promotes a more discreet appearance in public areas
- Fits through standard commercial doorways and onto elevators easily
- Optional hinged domed lid available
- Available in 1/2, 3/4, and 1 cu yd sizes
- Capacities up to 2,100 lbs



FG9T1600



The ergonomically designed "steering wheel" handle provides excellent handling and maneuvering.



Inset wheel position prevents damage to surroundings.

FG9T2200 Lid



1/2 CUBIC YARD TILT TRUCKS

No.	Color	Description	U.S. Dimensions	U.S. Size	U.S. Capacity	U.S. Ship Wt/Ctn	Metric Dimensions	Metric Size	Metric Capacity	Metric Ship Wt/Ctn	Pack
FG9T1300	BLA	Structural Foam Tilt Truck, Utility-Duty	57.38" l x 26.88" w x 33.88" h	1/2 cu yd	450 lb	86.9 lb	145.7 cm x 68.3 cm x 86.1 cm	0.4 m ³	204.1 kg	39.4 kg	1
FG9T1400	BLA	Structural Foam Tilt Truck, Standard-Duty	57.38" l x 26.88" w x 33.88" h	1/2 cu yd	850 lb	95.9 lb	145.7 cm x 68.3 cm x 86.1 cm	0.4 m ³	385.6 kg	43.5 kg	1
FG9T2200	BLA	Lid for 1/2 Cubic Yard Tilt Trucks	52" l x 27.88" w x 9" h	N/A	N/A	25.3 lb	132.1 cm x 70.8 cm x 22.9 cm	N/A	N/A	11.5 kg	1

3/4 CUBIC YARD TILT TRUCKS

No.	Color	Description	U.S. Dimensions	U.S. Size	U.S. Capacity	U.S. Ship Wt/Ctn	Metric Dimensions	Metric Size	Metric Capacity	Metric Ship Wt/Ctn	Pack
FG101100	BLA	Structural Foam Tilt Truck, Utility-Duty	64.5" l x 30.25" w x 38" h	3/4 cu yd	600 lb	92.0 lb	163.8 cm x 76.8 cm x 96.5 cm	.6 m ³	272.1 kg	41.7 kg	1
FG101300	BLA	Structural Foam Tilt Truck, Standard-Duty	64.5" l x 30.25" w x 38" h	3/4 cu yd	1,000 lb	101.0 lb	163.8 cm x 76.8 cm x 96.5 cm	.6 m ³	453.6 kg	45.8 kg	1
FG102800	BLA	Domed Lid for 3/4 Cubic Yard Tilt Trucks	61" l x 31.75" w x 8.75" h	N/A	N/A	24.8 lb	154.9 cm x 80.6 cm x 22.2 cm	N/A	N/A	11.2 kg	1

1 CUBIC YARD TILT TRUCKS

No.	Color	Description	U.S. Dimensions	U.S. Size	U.S. Capacity	U.S. Ship Wt/Ctn	Metric Dimensions	Metric Size	Metric Capacity	Metric Ship Wt/Ctn	Pack
FG9T1500	BLA	Structural Foam Tilt Truck, Standard-Duty	70.75" l x 33.5" w x 42.25" h	1 cu yd	1,250 lb	139.1 lb	179.7 cm x 85.1 cm x 107.3 cm	.8 m ³	566.9 kg	63.1 kg	1
FG9T1600	BLA	Structural Foam Tilt Truck, Heavy-Duty	70.75" l x 33.5" w x 42.25" h	1 cu yd	2,100 lb	141.1 lb	179.7 cm x 85.1 cm x 107.3 cm	.8 m ³	952.5 kg	64 kg	1
FG9T2300	BLA	Lid for 1 Cubic Yard Tilt Trucks	66.88" l x 34.5" w x 9" h	N/A	N/A	36.6 lb	169.9 cm x 87.6 cm x 22.9 cm	N/A	N/A	16.6 kg	1

Rotomolded Tilt Trucks

- Manufactured with traditional rotational molding technology
 - Easy to handle and maneuver
- Forkliftable model fully compatible with forklifts and many automated lifters
 Towable/Trainable models with pneumatic wheels for smooth movement over a variety of surfaces (5 mph maximum)
 USDA, FDA-compliant materials
 Recycling tilt truck comes standard with a permanent hot stamp of the universal recycle symbol
 Inset wheels on ½ and 1 cu yd models protect walls, fixtures, and patrons
 Smooth surface is easy to clean and resists pitting and corroding
 Optional hinged domed lid available on most models
 Available in ½, 1, 1½, 2 and 2½ cu yd sizes
 Capacities up to 2,300 lbs



AVAILABLE IN SIZES FROM ½ TO 2½ CUBIC YARDS.



½ CUBIC YARD TILT TRUCKS

No.	Color	Description	U.S. Dimensions	U.S. Size	U.S. Capacity	U.S. Ship Wt/Ctn	Metric Dimensions	Metric Size	Metric Capacity	Metric Ship Wt/Ctn	Pack
FG9T1700	BLA	Tilt Truck (RM)	56.75" l x 28" w x 38.63" h	½ cu yd	300 lb	138.5 lb	144.1 cm x 71.1 cm x 98.1 cm	0.4 m³	136.1 kg	62.8 kg	3
FG130400	BLA	Tilt Truck, Utility-Duty (RM)	56.75" l x 28" w x 38.63" h	½ cu yd	450 lb	62.5 lb	144.1 cm x 71.1 cm x 98.1 cm	0.4 m³	204.1 kg	28.3 kg	1
FG130500	YEL, RED, DBLUE, BLA	Tilt Truck, Standard-Duty (RM)	60.5" l x 28" w x 38.63" h	½ cu yd	850 lb	77.0 lb	153.7 cm x 71.1 cm x 98.1 cm	0.4 m³	385.6 kg	34.9 kg	1
FG130573	BLUE	Recycling Tilt Truck, Standard-Duty (RM)	60.5" l x 28" w x 38.63" h	½ cu yd	850 lb	77.0 lb	153.7 cm x 71.1 cm x 98.1 cm	0.4 m³	385.6 kg	34.9 kg	1
FG130600 ^a	BLA	Tilt Truck, Heavy-Duty (RM)	60.5" l x 28" w x 38.63" h	½ cu yd	1,400 lb	88.0 lb	153.7 cm x 71.1 cm x 98.1 cm	0.4 m³	635 kg	39.9 kg	1
FG130700 ^a	BLA	Lid for ½ Cubic Yard Tilt Trucks	56.5" l x 28.5" w x 9" h	N/A	N/A	22.3 lb	143.5 cm x 72.4 cm x 22.9 cm	N/A	N/A	10.1 kg	1

1 CUBIC YARD TILT TRUCKS

FG9T1800	BLA	Tilt Truck	72.25" l x 33.5" w x 43.75" h	1 cu yd	600 lb	259.5 lb	183.5 cm x 85.1 cm x 111.1 cm	0.8 m³	272.1 kg	117.7 kg	3
FG131400	BLA	Tilt Truck, Utility-Duty (RM)	72.25" l x 33.5" w x 43.75" h	1 cu yd	850 lb	111.0 lb	183.5 cm x 85.1 cm x 111.1 cm	0.8 m³	385.6 kg	50.3 kg	1
FG131500	YEL, RED, DBLUE, BLA	Tilt Truck, Standard-Duty (RM)	72.25" l x 33.5" w x 43.75" h	1 cu yd	1,250 lb	111.0 lb	183.5 cm x 85.1 cm x 111.1 cm	0.8 m³	567.0 kg	50.3 kg	1
FG131600	BLA	Tilt Truck, Heavy-Duty (RM)	72.25" l x 33.5" w x 43.75" h	1 cu yd	2,100 lb	120.0 lb	183.5 cm x 85.1 cm x 111.1 cm	0.8 m³	952.5 kg	54.4 kg	1
FG131700 ^a	BLA	Lid for 1 Cubic Yard Tilt Trucks	69.5" l x 34" w x 8.5" h	N/A	N/A	24.0 lb	176.5 cm x 86.4 cm x 21.6 cm	N/A	N/A	10.9 kg	1

1½ CUBIC YARD TILT TRUCKS

FG102500 ^a	BLA	Tilt Truck, Standard-Duty (RM)	80.5" l x 43" w x 49.5" h	1½ cu yd	1,200 lb	212.0 lb	204.5 cm x 109.2 cm x 125.7 cm	1.1 m³	544.3 kg	96.2 kg	1
FG102600 ^a	BLA	Tilt Truck, Heavy-Duty (RM)	80.5" l x 43" w x 49.5" h	1½ cu yd	2,100 lb	213.0 lb	204.5 cm x 109.2 cm x 125.7 cm	1.1 m³	952.5 kg	96.6 kg	1
FG102700	BLA	Lid for 1½ Cubic Yard Tilt Trucks	82.9" l x 44.5" w x 3" h	N/A	N/A	32.8 lb	210.5 cm x 113 cm x 7.6 cm	N/A	N/A	11.5 kg	1

2 CUBIC YARD TILT TRUCKS

FG103500 ^a	BLA	Tilt Truck, Standard-Duty (RM)	81.25" l x 46.75" w x 50" h	2 cu yd	1,900 lb	215.0 lb	206.4 cm x 118.7 cm x 127 cm	1.5 m³	861.8 kg	97.5 kg	1
FG103600 ^a	BLA	Tilt Truck, Heavy-Duty (RM)	81.25" l x 46.75" w x 50" h	2 cu yd	2,300 lb	238.5 lb	206.4 cm x 118.7 cm x 127 cm	1.5 m³	1043.3 kg	108.2 kg	1

2½ CUBIC YARD TILT TRUCKS

FG104500 ^a	BLA	Tilt Truck, Standard-Duty (RM)	81.5" l x 55.5" w x 50" h	2½ cu yd	1,900 lb	233.5 lb	207 cm x 141 cm x 127 cm	1.9 m³	861.8 kg	105.9 kg	1
FG104600 ^a	BLA	Tilt Truck, Heavy-Duty (RM)	81.5" l x 55.5" w x 50" h	2½ cu yd	2,300 lb	231.4 lb	207 cm x 141 cm x 127 cm	1.9 m³	1043.3 kg	105.0 kg	1

^aRequires up to 3 weeks lead time and is not returnable.

^aCustom colors available; contact Rubbermaid Customer Service for details.

*Pneumatic Wheels RM = Rotational Molded

WHEN ORDERING PRODUCTS WITH **BOLD** COLOR CODES, PLEASE SPECIFY COLOR CODE AFTER THE PRODUCT NUMBER. REFER TO THE PRODUCT COLOR GUIDE AT THE BACK OF THE CATALOG.



Check out the items marked with this symbol for our new line of Executive Series™ products.

Heavy-Duty Tilt Trucks

Towable and trainable tilt trucks for heavy-duty use:

- Heavy-duty tow bar, hitch, and frame for multiple truck towing and training up to 5 mph
- Pneumatic wheels provide smooth movement over rough terrain
- Available in ½, 1, and 1½ cu yd sizes

Forkliftable tilt trucks:

- Heavy-duty welded fork pockets allow easy transportation by forklift
- Suitable for a variety of work environments
- Available in ½, 1, and 1½ cu yd sizes



FG131641
Towable/
Trainable
Tilt Truck



FG131542
Forkliftable
Tilt Truck



½ CUBIC YARD TILT TRUCKS

No.	Color	Description	U.S. Dimensions	U.S. Size	U.S. Capacity	U.S. Ship Wt/Ctn	Metric Dimensions	Metric Size	Metric Capacity	Metric Ship Wt/Ctn	Pack
FG130641*	BLA	Towable Trainable Tilt Truck, Heavy-Duty (RM)	64" l x 29" w x 40" h	½ cu yd	1,400 lb	92.2 lb	162.6 cm x 73.7 cm x 101.6 cm	0.4 m³	635.0 kg	41.8 kg	1
FG130542	BLA	Forkliftable Tilt Truck, Standard-Duty (RM)	60.5" l x 28" w x 38.63" h	½ cu yd	850 lb	77.0 lb	153.7 cm x 71.1 cm x 98.1 cm	0.4 m³	385.6 kg	34.9 kg	1

1 CUBIC YARD TILT TRUCKS

No.	Color	Description	U.S. Dimensions	U.S. Size	U.S. Capacity	U.S. Ship Wt/Ctn	Metric Dimensions	Metric Size	Metric Capacity	Metric Ship Wt/Ctn	Pack
FG131641*	BLA	Towable Trainable Tilt Truck, Heavy-Duty (RM)	72.5" l x 33.5" w x 42.25" h	1 cu yd	2,100 lb	178.0 lb	184.2 cm x 85.1 cm x 107.3 cm	0.8 m³	952.6 kg	80.7 kg	1
FG131542	BLA	Forkliftable Tilt Truck, Standard-Duty (RM)	72.25" l x 33.5" w x 43.75" h	1 cu yd	1,250 lb	124.0 lb	183.5 cm x 85.1 cm x 111.1 cm	0.8 m³	567.0 kg	56.2 kg	1

1½ CUBIC YARD TILT TRUCKS

No.	Color	Description	U.S. Dimensions	U.S. Size	U.S. Capacity	U.S. Ship Wt/Ctn	Metric Dimensions	Metric Size	Metric Capacity	Metric Ship Wt/Ctn	Pack
FG102641*	BLA	Towable Trainable Tilt Truck, Heavy-Duty (RM)	91.25" l x 45" w x 51.75" h	1½ cu yd	2,100 lb	243.8 lb	231.8 cm x 114.3 cm x 131.4 cm	1.1 m³	952.5 kg	110.6 kg	1
FG102542*	BLA	Forkliftable Tilt Truck, Standard-Duty (RM)	80.5" l x 43" w x 49.5" h	1½ cu yd	1,200 lb	212.0 lb	204.5 cm x 109.2 cm x 125.7 cm	1.1 m³	544.3 kg	96.2 kg	1

*Requires 3-week lead time and is not returnable.

*Pneumatic Wheels RM = Rotational Molded

Heavy-Duty Tilt Truck Lids

Domed, hinged lids provide convenient access to contents without reducing overall capacity.



FG102700

HEAVY-DUTY TILT TRUCK LIDS

No.	Color	Description	U.S. Dimensions	U.S. Size	U.S. Capacity	U.S. Ship Wt/Ctn	Metric Dimensions	Metric Size	Metric Capacity	Metric Ship Wt/Ctn	Pack
FG130700	BLA	Lid for ½ Cubic Yard Tilt Trucks	56.5" l x 28.5" w x 9" h	N/A	N/A	22.3 lb	143.5 cm x 72.4 cm x 22.9 cm	N/A	N/A	10.1 kg	1
FG131700	BLA	Lid for 1 Cubic Yard Tilt Trucks	69.5" l x 34" w x 8.5" h	N/A	N/A	24.0 lb	176.5 cm x 86.4 cm x 21.6 cm	N/A	N/A	10.9 kg	1
FG102700	BLA	Lid for 1½ Cubic Yard Tilt Trucks	82.88" l x 44.5" w x 3" h	N/A	N/A	32.8 lb	210.5 cm x 113 cm x 7.6 cm	N/A	N/A	14.9 kg	1

Self-Dumping Hoppers

Large-capacity hoppers store and dump heavy loads with ease.

- Forklift-compatible for elevated dumping
- Tilts a full 30° below horizontal to ensure complete dumping
- Pull-release safety latch prohibits premature dumping
- Rugged, functional plastic body positioned on heavy-duty metal frame
- Resists rusting, denting, and pitting that can affect metal hoppers
- Mobile models use four 6" polyolefin casters
- Optional lid available for FG106400 and FG106443 models



FG106400



FG105443

½ CUBIC YARD HOPPERS

No.	Color	Description	U.S. Dimensions	U.S. Size	U.S. Capacity	U.S. Ship Wt/Ctn	Metric Dimensions	Metric Size	Metric Capacity	Metric Ship Wt/Ctn	Pack
FG105400	BLA	Self-Dumping Hopper	55" l x 26.25" w x 40" h	½ cu yd	750 lb	194.0 lb	139.7 cm x 66.7 cm x 101.6 cm	.4 m ³	340.2 kg	88 kg	1
FG105443	BLA	Self-Dumping Hopper with four 6" dia (15.2 cm) Polyolefin Casters	55" l x 26.25" w x 47.63" h	½ cu yd	750 lb	212.0 lb	139.7 cm x 66.7 cm x 121 cm	.4 m ³	340.2 kg	96.2 kg	1
FG130700	BLA	Lid for ½ Cubic Yard Hoppers	56.5" l x 28.5" w x 9" h	N/A	N/A	22.3 lb	143.5 cm x 72.4 cm x 22.9 cm	N/A	N/A	10.1 kg	1

1 CUBIC YARD HOPPERS

No.	Color	Description	U.S. Dimensions	U.S. Size	U.S. Capacity	U.S. Ship Wt/Ctn	Metric Dimensions	Metric Size	Metric Capacity	Metric Ship Wt/Ctn	Pack
FG105900	BLA	Self-Dumping Hopper	71.5" l x 31.25" w x 44.88" h	1 cu yd	1,000 lb	230.0 lb	181.6 cm x 79.4 cm x 114 cm	.8 m ³	453.6 kg	104.3 kg	1
FG105943	BLA	Self-Dumping Hopper with four 6" dia (15.2 cm) Polyolefin Casters	71.5" l x 31.25" w x 52.5" h	1 cu yd	1,000 lb	247.0 lb	181.6 cm x 79.4 cm x 133.4 cm	.8 m ³	453.6 kg	112 kg	1
FG131700	BLA	Lid for 1 Cubic Yard Hoppers	69.5" l x 34" w x 8.5" h	N/A	N/A	24.0 lb	176.5 cm x 86.4 cm x 21.6 cm	N/A	N/A	10.9 kg	1

1½ CUBIC YARD HOPPERS

No.	Color	Description	U.S. Dimensions	U.S. Size	U.S. Capacity	U.S. Ship Wt/Ctn	Metric Dimensions	Metric Size	Metric Capacity	Metric Ship Wt/Ctn	Pack
FG106400 ^a	BLA	Self-Dumping Hopper	83.63" l x 42.88" w x 49.13" h	1½ cu yd	1,000 lb	307.0 lb	212.4 cm x 108.9 cm x 124.8 cm	1.1 m ³	453.6 kg	139.3 kg	1
FG106443 ^a	BLA	Self-Dumping Hopper with four 6" dia (15.2 cm) Polyolefin Casters	83.63" l x 42.88" w x 56.25" h	1½ cu yd	1,000 lb	360.5 lb	212.4 cm x 108.9 cm x 142.9 cm	1.1 m ³	453.6 kg	163.5 kg	1
FG102700	BLA	Lid for 1½ Cubic Yard Hoppers	82.88" l x 44.5" w x 3" h	N/A	N/A	32.8 lb	210.5 cm x 113 cm x 7.6 cm	N/A	N/A	14.9 kg	1

2 CUBIC YARD HOPPERS

No.	Color	Description	U.S. Dimensions	U.S. Size	U.S. Capacity	U.S. Ship Wt/Ctn	Metric Dimensions	Metric Size	Metric Capacity	Metric Ship Wt/Ctn	Pack
FG106900 ^a	BLA	Self-Dumping Hopper	83.88" l x 46" w x 49.5" h	2 cu yd	1,000 lb	303.2 lb	213.1 cm x 116.8 cm x 125.7 cm	1.5 m ³	453.6 kg	137.5 kg	1
FG106943 ^a	BLA	Self-Dumping Hopper with four 6" dia (15.2 cm) Polyolefin Casters	83.88" l x 46" w x 57.63" h	2 cu yd	1,000 lb	353.0 lb	213.1 cm x 116.8 cm x 146.4 cm	1.5 m ³	453.6 kg	160.1 kg	1

2½ CUBIC YARD TILT TRUCKS

No.	Color	Description	U.S. Dimensions	U.S. Size	U.S. Capacity	U.S. Ship Wt/Ctn	Metric Dimensions	Metric Size	Metric Capacity	Metric Ship Wt/Ctn	Pack
FG107400 ^a	BLA	Self-Dumping Hopper	83.5" l x 55" w x 49.5" h	2½ cu yd	1,000 lb	304.5 lb	212.1 cm x 139.7 cm x 125.7 cm	1.9 m ³	453.6 kg	138.1 kg	1
FG107443 ^a	BLA	Self-Dumping Hopper with four 6" dia (15.2 cm) Polyolefin Casters	83.5" l x 55" w x 56.63" h	2½ cu yd	1,000 lb	376.0 lb	212.1 cm x 139.7 cm x 143.8 cm	1.9 m ³	453.6 kg	170.5 kg	1

^aCustom colors available; contact Rubbermaid Customer Service for details.

^aRequires 3 weeks lead time and are non-returnable.

WHEN ORDERING PRODUCTS WITH **BOLD** COLOR CODES,
PLEASE SPECIFY COLOR CODE AFTER THE PRODUCT NUMBER.
REFER TO THE PRODUCT COLOR GUIDE AT THE BACK OF THE CATALOG.



Check out the items marked with this symbol for our new line of Executive Series™ products.

Cube Trucks

A complete line of trucks for waste collection, material transport, and laundry handling, with the durability of Rotational Molding technology.

- Diamond caster pattern provides superior maneuverability
- Towable trainable model offers corner casters
- Assists in complying with HACCP guidelines
- Spring platform option elevates contents for easier loading and unloading
- Heavy-duty utility models include metal body support band
- Optional hinged domed lid available



8 CUBIC FOOT (6.4 BUSHEL)

No.	Color	Description	U.S. Dimensions	U.S. Bushel (BU)	U.S. Size	U.S. Capacity	U.S. Ship Wt/Ctn	Metric Dimensions	Metric Size	Metric Capacity	Metric Ship Wt/Ctn	Pack
FG460800	WHT, DBLUE, BLA, YEL, RED	Cube Truck	38" l x 26" w x 28.13" h	6.4	8 cu ft	300 lb	36.0 lb	96.5 cm x 66 cm x 71.5 cm	.2 m ³	136.1 kg	16.3 kg	1
FG470800	BLA	Utility Truck, Heavy-Duty with 4" dia (10.2 cm) Casters	38.38" l x 26" w x 28.25" h	6.4	8 cu ft	700 lb	48.0 lb	97.5 cm x 66 cm x 71.8 cm	.2 m ³	317.5 kg	21.8 kg	1
FG460900 ^a	BLA	Lid for 8 ft. ³ Cube Trucks	38.38" l x 25.75" w x 8.5" h				13.5 lb	97.5 cm x 65.4 cm x 21.6 cm			6.1 kg	1

12 CUBIC FOOT (9.6 BUSHEL)

FG461200	WHT, DBLUE, YEL, RED, BLA	Cube Truck	42.75" l x 28" w x 33" h	9.6	12 cu ft	400 lb	40.0 lb	108.6 cm x 71.1 cm x 83.8 cm	.3 m ³	181.4 kg	18.1 kg	1
FG471200	BLA	Utility Truck, Heavy-Duty with 4" dia (10.2 cm) Casters	43.25" l x 28" w x 33.88" h	9.6	12 cu ft	800 lb	62.3 lb	109.9 cm x 71.1 cm x 86.1 cm	.3 m ³	362.9 kg	28.3 kg	1
FG461300 ^a	BLA	Lid for 12 ft. ³ Cube Trucks	43.13" l x 27.5" w x 8.5" h				15.1 lb	109.6 cm x 69.9 cm x 21.6 cm			6.8 kg	1

14 CUBIC FOOT (11.3 BUSHEL)

FG461100	BLA	Spring Platform Truck	44.13" l x 31" w x 32.5" h	11.3	14 cu ft	500 lb	60.0 lb	112.1 cm x 78.7 cm x 82.6 cm	.4 m ³	226.8 kg	27.2 kg	1
FG461400	WHT, BLUE, BLA, YEL, RED	Cube Truck	44.13" l x 31" w x 32.5" h	11.3	14 cu ft	500 lb	47.0 lb	112.1 cm x 78.7 cm x 82.6 cm	.4 m ³	226.8 kg	21.3 kg	1
FG461500 ^a	BLA	Lid for 14 ft. ³ Cube Trucks	44.13" l x 31" w x 8.5" h				17.2 lb	112.1 cm x 78.7 cm x 21.6 cm			7.8 kg	1

16 CUBIC FOOT (12.9 BUSHEL)

FG461600	WHT, DBLUE, BLA, YEL, RED	Cube Truck	43.75" l x 31" w x 37" h	12.9	16 cu ft	500 lb	51.0 lb	111.1 cm x 78.7 cm x 94 cm	.5 m ³	226.8 kg	23.1 kg	1
FG461673	BLUE	Recycling Cube Truck	43.75" l x 31" w x 37" h	12.9	16 cu ft	500 lb	51.0 lb	111.1 cm x 78.7 cm x 94 cm	.5 m ³	226.8 kg	23.1 kg	1
FG471600	BLA	Utility Truck, Heavy-Duty with 5" dia (12.7 cm) Casters	44.38" l x 31" w x 38.25" h	12.9	16 cu ft	1,000 lb	74.3 lb	112.7 cm x 78.7 cm x 97.2 cm	.5 m ³	453.6 kg	33.7 kg	1
FG461500 ^a	BLA	Lid for 16 ft. ³ Cube Trucks	44.13" l x 31" w x 8.5" h				17.2 lb	112.1 cm x 78.7 cm x 21.6 cm			7.8 kg	1

20 CUBIC FOOT (16.1 BUSHEL)

FG461900	BLA, BLUE, YEL, RED	Cube Truck	48" l x 34.1" w x 36.5" h	16.1	20 cu ft	600 lb	60.0 lb	121.9 cm x 86.7 cm x 92.7 cm	.6 m ³	272.2 kg	27.2 kg	1
FG461800	BLA	Spring Platform Truck	48" l x 34.1" w x 36.5" h	16.1	20 cu ft	600 lb	75.0 lb	121.9 cm x 86.7 cm x 92.7 cm	.6 m ³	272.2 kg	34.0 kg	1
FG472000	BLA	Utility Truck, Heavy-Duty with 5" dia (12.7 cm) Casters	48.25" l x 34.1" w x 37.9" h	16.1	20 cu ft	1,200 lb	84.8 lb	122.6 cm x 86.7 cm x 96.2 cm	.6 m ³	544.3 kg	38.5 kg	1
FG461700 ^a	BLA	Lid for 20 ft. ³ Cube Trucks	48.5" l x 34" w x 8.5" h				18.8 lb	123.2 cm x 86.4 cm x 21.6 cm			8.5 kg	1

27 CUBIC FOOT (21.7 BUSHEL)

FG472700	BLA	Utility Truck, Heavy-Duty with 5" dia (12.7 cm) Corner Casters	59" l x 34" w x 42.9" h	21.7	27 cu ft	1,200 lb	105.0 lb	149.9 cm x 86.4 cm x 108.9 cm	.8 m ³	544.3 kg	47.6 kg	1
FG472741*	BLA	Towable Utility Truck, Heavy-Duty	59" l x 34" w x 42.9" h	21.7	27 cu ft	1,200 lb	120.0 lb	149.9 cm x 86.4 cm x 108.9 cm	.8 m ³	544.3 kg	54.4 kg	1
FG472600	BLA	Lid for 27 ft. ³ Cube Trucks	59.88" l x 34.5" w x 5" h				19.9 lb	152.1 cm x 87.6 cm x 12.7 cm			9.0 kg	1

*Requires 2 weeks lead time and are nonreturnable.

^aCustom colors available; contact Customer Service for details.

REPLACEMENT SPRING KIT

No.	Color	Description	U.S. Dimensions	U.S. Ship Wt/Ctn	Metric Ship Wt/Ctn	Pack
FG461000	0000	Spring Kit for FG461100, FG461400 Trucks	34.2" l x 21.2" w x 0.5" h	12.0 lb	5.4 kg	1
FG462500	0000	Spring Kit for FG461800, FG461900 Trucks	37.7" l x 24" w x 0.5" h	15.0 lb	6.8 kg	1

BRUTE® Totes

The ultimate storage and transport container.

- Reinforced ribbed bottom protects container during dragging
- User-friendly grip handles decrease potential for back injury and finger strain
- Lid snaps tight, keeping contents secure



FG9S3000 / FG9S3100



FG9S3000 / FG440000

No.	Color	Description	U.S. Dimensions	U.S. Capacity	U.S. Ship Wt/Ctn	Metric Dimensions	Metric Capacity	Metric Ship Wt/Ctn	Pack
FG9S3000	WHT, GRAY	BRUTE® Tote with Lid	27.88" l x 16.5" w x 10.7" h	14 gal	46.0 lb	70.8 cm x 41.9 cm x 27.2 cm	53 L	20.9 kg	6
FG9S3100	WHT, GRAY	BRUTE® Tote with Lid	27.88" l x 17.38" w x 15.13" h	20 gal	53.0 lb	70.8 cm x 44.1 cm x 38.4 cm	75.7 L	24 kg	6

Stack and Nest Palletote® Boxes

For cost-effective storage and transportation.

- Fits 40" and 48" pallets with no overhang
- Nestable for efficient storage and transport, stackable with and without lids
- All plastic construction won't rust, dent, chip, or peel
- Rounded corners and smooth surfaces are easy to clean
- USDA 3A (Dairy) Sanitary Standards and Meat and Poultry Equipment Group Listed
- Slip-resistant, extended bottom
- Materials are FDA-compliant for food contact and certified to NSF Std. #2



FG172100



FG173200

No.	Color	Description	U.S. Dimensions	U.S. Capacity	U.S. Ship Wt/Ctn	Metric Dimensions	Metric Capacity	Metric Ship Wt/Ctn	Pack
FG172100	GRAY	Palletote® Box	19.5" l x 15.5" w x 10" h	1.3 cu ft	42.6 lb	49.5 cm x 39.4 cm x 25.4 cm	.04 m ³	19.3 kg	10
FG172200	GRAY	Palletote® Box	19.5" l x 15.5" w x 13" h	1.6 cu ft	57.9 lb	49.5 cm x 39.4 cm x 33.0 cm	.05 m ³	26.3 kg	10
FG173100	GRAY	Palletote® Box	23.5" l x 19.5" w x 10" h	2 cu ft	60.6 lb	59.7 cm x 49.5 cm x 25.4 cm	.06 m ³	27.5 kg	10
FG173200	GRAY	Palletote® Box	23.5" l x 19.5" w x 13" h	2.6 cu ft	92.2 lb	59.7 cm x 49.5 cm x 33.0 cm	.07 m ³	41.8 kg	10

LIDS

No.	Color	Description	U.S. Dimensions	U.S. Ship Wt/Ctn	Metric Dimensions	Metric Ship Wt/Ctn	Pack
FG172000	GRAY	Palletote® Lid for FG172100, FG172200	19.63" l x 15.63" w x 1" h	16.1 lb	49.9 cm x 39.7 cm x 2.5 cm	7.3 kg	10
FG173000	GRAY	Palletote® Lid for FG173100, FG173200	23.75" l x 19.75" w x 1" h	22.1 lb	60.3 cm x 50.2 cm x 2.5 cm	10 kg	10

Tool Boxes

Professional-grade tool boxes for commercial/industrial use.

- Made of sturdy structural foam construction that won't rust, dent, chip, or peel
- Removable trays provide added compartmentalized storage area
- Metal latches can be padlocked for security



FG780200



FG780400

Tack Box with Padded Top

Super-tough structural foam construction for durable, all-purpose storage at the work site, in the stable, or on the water.

- Padded 2" cushion for comfortable seating
- Heavy-duty structural foam construction
- Two interior trays provide storage for small items
- Castor kit available (FG772100)
- Lockable for added security
- Molded-in side handles make lifting and transporting of heavy loads easier



FG772000

No.	Color	Description	U.S. Dimensions	U.S. Ship Wt/Ctn	Metric Dimensions	Metric Ship Wt/Ctn	Pack
FG780200	BLA	Tool Box	26" l x 11.5" w x 11.13" h	21.7 lb	66.0 cm x 29.2 cm x 28.3 cm	9.8 kg	2
FG780400	BLA	Tool Box	36" l x 18.5" w x 20.13" h	33.0 lb	91.4 cm x 47 cm x 51.1 cm	15 kg	1
FG772000	BLA	Structural Foam Tack Box	36" l x 18.5" w x 22.375" h	36.2 lb	91.4 cm x 45.7 cm x 61.0 cm	16.4 kg	1

WHEN ORDERING PRODUCTS WITH **BOLD** COLOR CODES, PLEASE SPECIFY COLOR CODE AFTER THE PRODUCT NUMBER. REFER TO THE PRODUCT COLOR GUIDE AT THE BACK OF THE CATALOG.



Check out the items marked with this symbol for our new line of Executive Series™ products.

ActionPacker® Storage Containers

Organized tool storage and transportation for industry professionals.

- Durable, weather-resistant construction
- Tough, lockable latches keep contents secure
- Stackable containers are easily tied down with bungee cords



FG11720438



FG11920138



FG11920138

No.	Color	Description	U.S. Dimensions	U.S. Capacity	U.S. Ship Wt/Ctn	Metric Dimensions	Metric Capacity	Metric Ship Wt/Ctn	Pack
FG11720438	BLA	ActionPacker® Storage Container	26.1" l x 16.9" w x 18.6" h	24 gal	45.4 lb	66.3 cm x 42.9 cm x 47.2 cm	90.8 L	20.6 kg	4
FG11910138	BLA	ActionPacker® Cargo Box	34.5" l x 16.38" w x 18.5" h	35 gal	24.0 lb	87.6 cm x 41.6 cm x 47 cm	132.5 L	10.9 kg	1
FG11920138	BLA	ActionPacker® Cargo Box	43.75" l x 17.2" w x 20.5" h	48 gal	28.9 lb	111.1 cm x 43.7 cm x 52.1 cm	181.6 L	13.1 kg	1

Stock Tanks

Super-tough structural foam construction for superior performance and durability in all kinds of weather.

- Five sizes to fit all your watering needs, from 50 to 300 gallons
- Seamless construction for outstanding durability
- Oversize 1½" drain plug for easy draining and cleaning
- All-plastic anti-siphon float valve provides constant water level

FLOAT VALVE OPTION



FG424806 fits all Rubbermaid® Stock Tanks.

STEPPED SIDEWALLS ■
Resist bowing and provided added stability.

SEAMLESS DESIGN ■
Prevents leaking and cracking.

REINFORCED RIBBING ■
Provides added strength and durability.



FG424288

FG424700

FG424500

FG424400

FG424300

No.	Color	Description	U.S. Dimensions	U.S. Capacity	U.S. Ship Wt/Ctn	Metric Dimensions	Metric Capacity	Metric Ship Wt/Ctn	Pack
FG424288	BLA	100 U.S. gal Stock Tank	53" l x 31" w x 25" h	100 gal	32.4 lb	134.6 cm x 78.7 cm x 63.5 cm	378.5 L	14.7 kg	1
FG424300	BLA	50 U.S. gal Stock Tank	52" l x 31" w x 12" h	50 gal	23.5 lb	132.1 cm x 78.7 cm x 30.5 cm	189.2 L	10.7 kg	1
FG424400	BLA	70 U.S. gal Stock Tank	40.5" l x 32" w x 24" h	70 gal	24.0 lb	102.9 cm x 81.3 cm x 61 cm	265.0 L	10.9 kg	1
FG424500	BLA	150 U.S. gal Stock Tank	58" l x 39" w x 25" h	150 gal	53.0 lb	147.3 cm x 99.1 cm x 63.5 cm	567.8 L	24.0 kg	1
FG424700	BLA	300 U.S. gal Stock Tank	63.25" l x 69" w x 25" h	300 gal	83.0 lb	160.7 cm x 175.3 cm x 63.5 cm	1135.5 L	37.6 kg	1
FG424806	BLA	Stock Tank Float Valve	9" l x 5" w x 6.25" h	N/A	12.0 lb	22.9 cm x 12.7 cm x 15.9 cm	N/A	5.4 kg	6
FG505012		Stock Tank Drain Plug Kit	N/A	N/A	2.5 lb	N/A	N/A	1.1 kg	12

Heavy-Duty Tractor Carts

Versatile carts to carry almost any load.

- Three sizes to suit a variety of uses
- Smooth, seamless interior makes dumping and cleaning easy
- Heavy-duty structural foam construction for durability
- Oversized pneumatic tires easily maneuver through rough terrain
- Hefty carbon-steel axle helps increase load-bearing effectiveness



FG566261



FG566000

No.	Color	Description	U.S. Dimensions	U.S. Load	U.S. Size	U.S. Ship Wt/Ctn	Metric Dimensions	Metric Load	Metric Size	Metric Ship Wt/Ctn	Pack
FG566000	BLA	10 Cu. Ft. Tractor Cart (Assembled)	68" l x 35.5" w x 29.5" h	1,200 lb	10 cu ft	101.7 lb	172.7 cm x 90.2 cm x 74.9 cm	554 kg	.28 m ³	46.1 kg	1
FG566261	BLA	8 Cu. Ft. Tractor Cart (Unassembled)	60" l x 39.25" w x 25" h	750 lb	8 cu ft	62.5 lb	152.4 cm x 99.7 cm x 63.5 cm	340.2 kg	.226 m ³	28.3 kg	1
FG566361	BLA	15 Cu. Ft. Tractor Cart (Unassembled), Black	75.9" l x 39.5" w x 33.25" h	1,500 lb	15 cu ft	111.7 lb	192.8 cm x 100.3 cm x 84.5 cm	680 kg	.424 m ³	50.7 kg	1
51566000		Axle for FG566000, FG566061	N/A	N/A	N/A	N/A	N/A	N/A	N/A	N/A	1
M1566000		Wheel for FG566000, FG566061	N/A	N/A	N/A	N/A	N/A	N/A	N/A	N/A	1
M1566200		Wheel for FG566261	N/A	N/A	N/A	N/A	N/A	N/A	N/A	N/A	1
20566300		Wheel for FG566361	N/A	N/A	N/A	N/A	N/A	N/A	N/A	N/A	1
50566200		Axle for FG566261	N/A	N/A	N/A	N/A	N/A	N/A	N/A	N/A	1
50566300		Axle for FG566361	N/A	N/A	N/A	N/A	N/A	N/A	N/A	N/A	1

Big Wheel® Carts

Designed for heavy-duty, long-lasting use.

- Smooth, all-plastic, one-piece tub construction is easy to dump and clean
- Large pneumatic wheel provides maneuverability (FG564200)
- Large 20" semi-pneumatic wheels roll smoothly over rough surfaces (FG565461)
- FG565461 has a weighted load capacity of 200 lbs and holds up to 3.5 cu ft (.09 m³) level capacity or 4.0 cu ft (.11 m³) heaped capacity
- FG564200 has a weighted load capacity of 300 lbs and holds up to 7.5 cu ft (.2 m³) level capacity or 8.75 cu ft (.25 m³) heaped capacity



FG564200



No.	Color	Description	U.S. Dimensions	U.S. Load	U.S. Size	U.S. Ship Wt/Ctn	Metric Dimensions	Metric Load	Metric Size	Metric Ship Wt/Ctn	Pack
FG564200	BLA	7.5 Cu. Ft. Big Wheel® Cart	58" l x 32.75" w x 28.25" h	300 lb	7.5 cu ft	45.2 lb	147.3 cm x 83.2 cm x 71.8 cm	136 kg	.21 m ³	20.5 kg	1
FG564261	BLA	7.5 Cu. Ft. Big Wheel® Cart (Unassembled)	58" l x 32.75" w x 28.25" h	300 lb	7.5 cu ft	49.3 lb	147.3 cm x 83.2 cm x 71.8 cm	136 kg	.21 m ³	22.4 kg	1
FG565461	BLA	3.5 Cu. Ft. Big Wheel® Cart (Unassembled)	47" l x 27.5" w x 24.75" h	200 lb	3.5 cu ft	38.2 lb	119.4 cm x 69.9 cm x 62.9 cm	90.7 kg	.09 m ³	17.3 kg	1
M1564200		Wheel for FG564200, FG564261	N/A	N/A	N/A	N/A	N/A	N/A	N/A	N/A	1
M1565400		Wheel for FG565461	N/A	N/A	N/A	N/A	N/A	N/A	N/A	N/A	1
22564210		Wheel for FG564210	N/A	N/A	N/A	N/A	N/A	N/A	N/A	N/A	1
50565400		Axle for FG565461	N/A	N/A	N/A	N/A	N/A	N/A	N/A	N/A	1
52564200		Axle for FG564200, FG564261	N/A	N/A	N/A	4.93 lb	N/A	N/A	N/A	N/A	1

WHEN ORDERING PRODUCTS WITH **BOLD** COLOR CODES, PLEASE SPECIFY COLOR CODE AFTER THE PRODUCT NUMBER. REFER TO THE PRODUCT COLOR GUIDE AT THE BACK OF THE CATALOG.



Check out the items marked with this symbol for our new line of Executive Series™ products.

Heavy-Duty Big Wheel® Cart

Suitable for industrial, commercial, and agricultural work.

- Lightweight Low Wheel Cart (FG564000) carries loads up to 300 lbs
- Strong, durable one-piece construction carries up to 700 lbs (FG564210)
- High-flotation, 8" wide wheels provide easy mobility over most surfaces
- Reinforced steel axle for heavy-duty hauling



FG564210



FG564000

No.	Color	Description	U.S. Dimensions	U.S. Load	U.S. Size	U.S. Ship Wt/Ctn	Metric Dimensions	Metric Load	Metric Size	Metric Ship Wt/Ctn	Pack
FG564000	BLA	7.5 Cu. Ft. Low Wheel Cart (Unassembled)	58" l x 33.75" w x 28.25" h	300 lb	7.5 cu ft	45.8 lb	147.3 cm x 85.7 cm x 71.8 cm	136 kg	.21 m ³	20.8 kg	1
FG564210	BLA	7.5 Cu. Ft. Heavy-Duty Big Wheel® Cart	57" l x 41" w x 26" h	700 lb	7.5 cu ft	55.0 lb	144.8 cm x 104.1 cm x 66 cm	317 kg	.21 m ³	24.9 kg	1
22564210		Wheel for FG564210	N/A	N/A	N/A	N/A	N/A	N/A	N/A	N/A	1
20564020		Wheel for FG564000	N/A	N/A	N/A	N/A	N/A	N/A	N/A	N/A	1
50564205		Axle for FG564000	N/A	N/A	N/A	N/A	N/A	N/A	N/A	N/A	1

Contractor-Grade Wheelbarrows

Engineered for tough, durable performance.

- Smooth, one-piece seamless pan prevents leaking
- Long-lasting hardwood handles for added strength and steady handling
- Durable, oversized pneumatic tire maneuvers easily
- Carries up to 200 lbs



FG565861



FG565961

No.	Color	Description	U.S. Dimensions	U.S. Capacity	U.S. Ship Wt/Ctn	Metric Dimensions	Metric Capacity	Metric Ship Wt/Ctn	Pack
FG565861	BLA	6.5 Cu. Ft. Contractor Wheelbarrow (Unassembled)	60" l x 27" w x 27.5" h	6.5 cu ft	50.7 lb	152.4 cm x 68.6 cm x 69.9 cm	.18 m ³	23.0 kg	1
FG565961	BLA	6.5 Cu. Ft. Two-Wheel Contractor Wheelbarrow (Unassembled)	60" l x 27" w x 27.5" h	6.5 cu ft	57.5 lb	152.4 cm x 68.6 cm x 69.9 cm	.18 m ³	26.1 kg	1
53565800		Axle for FG565861	N/A	N/A	N/A	N/A	N/A	N/A	1
70565900		Axle for FG565961	N/A	N/A	N/A	N/A	N/A	N/A	1
925658C1	BLA	Axle Retainer for FG565861	N/A	N/A	N/A	N/A	N/A	N/A	2
925659C1	BLA	Axle Retainer for FG565961	N/A	N/A	N/A	N/A	N/A	N/A	2
M1565800		Wheel for FG565861	N/A	N/A	N/A	N/A	N/A	N/A	1
M1565900		Wheel for FG565961	N/A	N/A	N/A	N/A	N/A	N/A	1
NP565804		Wheelbarrow Handle Kit (2 wood handles), fits FG565861 and FG565961	N/A	N/A	N/A	N/A	N/A	N/A	1

Utility Lawn Carts

Designed to move loads quickly and easily.

- Easy to lift and dump; handle features molded-in tool/beverage holder
- Smooth interior is easy to clean
- FG370712 holds up to 3.25 cu ft (.09 m³) level capacity or 4.5 cu ft (.127 m³) heaped capacity
- FG370612 holds up to 4.5 cu ft (.127 m³) level capacity or 5.75 cu ft (.16 m³) heaped capacity



FG370612



FG370712

No.	Color	Description	U.S. Dimensions	U.S. Load	U.S. Size	U.S. Ship Wt/Ctn	Metric Dimensions	Metric Load	Metric Size	Metric Ship Wt/Ctn	Pack
FG370612	714	4.5 Cu. Ft. Roughneck Lawn Cart Pallet, Green	48" l x 23.5" w x 28" h	200 lb	4.5 cu ft	235.9 lb	121.9 cm x 59.7 cm x 71.1 cm	90.7 kg	.13 m ³	107 kg	12
FG370712	907	3.25 Cu. Ft. Roughneck Lawn Cart Pallet, Platinum	42.5" l x 21" w x 28" h	200 lb	3.25 cu ft	195.6 lb	108 cm x 53.3 cm x 71.1 cm	90.7 kg	.09 m ³	88.7 kg	12



Work Safer, Work Smarter

Rubbermaid Commercial Products' safety systems are designed to work with a wide variety of Rubbermaid® products, including Mobile Barriers, Over-the-Spill® Systems, Cleaning Carts, WaveBrake® Mopping Trolleys, and BRUTE® Rim Caddies, to help make cleaning and waste management more efficient—and safer.





BARRIERS AND SAFETY SIGNS

Stable Safety Signs 242
 Floor Safety Signs 242
 Wooden Safety Signs 243
 Mobile Barrier 243

SAFETY CONES

Cone Barrier System 244
 Pop-Up Safety Cones 244
 Folding Safety Cones 244
 Safety Cones and Accessories 245
 Site Safety Hanging Signs 245

SAFETY SIGNS AND OVER-THE-SPILL® SYSTEM

Hanging Safety Sign 246
 Over-the-Spill® System 247

Stable Safety Signs

Unique “no tip” design and bold graphics quickly capture pedestrian attention.

- Folds for convenient storage and transport on Janitor Cart (FG617388) or Rim Caddy (FG9W8700)
- Large, 13" warning triangle with bold graphics
- Only 1½" thick when closed
- Self-opening feet provide a wide, stable base
- Low center of gravity helps prevent tipping when bumped, kicked, or windblown
- ANSI and OSHA compliant color and graphics**



FG9S0925



No.	Color	Description	U.S. Dimensions	U.S. Ship Wt/Ctn	Metric Dimensions	Metric Ship Wt/Ctn	Pack
FG950900	YEL	Stable Safety Sign with “Caution” Imprint, English, Spanish, French	Open: 26" l x 13" w x 13½" d Closed: 32¼" l x 13" w x 1½" d	9.5 lb	Open: 66 cm x 33 cm x 33.6 cm Closed: 81.9 cm x 33 cm x 3.8 cm	4.3 kg	6
FG950925	YEL	Stable Safety Sign with International Wet Floor Symbol	Open: 26" l x 13" w x 13½" d Closed: 32¼" l x 13" w x 1½" d	9.5 lb	Open: 66 cm x 33 cm x 33.6 cm Closed: 81.9 cm x 33 cm x 3.8 cm	4.3 kg	6

Floor Safety Signs

Lightweight, versatile signs for effective safety communication.

- “Closed” and “Caution” warning messages imprinted in English, French, and Spanish
- Folds for convenient storage and transport on Janitorial Carts or Rim Caddy (FG9W8700)
- Two- and four-sided models available
- ANSI- and OSHA-compliant color* and graphics**



No.	Color	Description	U.S. Dimensions	U.S. Ship Wt/Ctn	Metric Dimensions	Metric Ship Wt/Ctn	Pack
FG611200*	YEL	Floor Sign with Multilingual “Caution” Imprint, 2-Sided	Open: 26" l x 11" w x 25" h Closed: 26" l x 11" w	15.0 lb	Open: 66 cm x 27.9 cm x 63.5 cm Closed: 66 cm x 27.9 cm	6.8 kg	6
New! ES 1867505	BLACK	Executive Series™ Floor Sign with Multilingual “Caution” Imprint, 2-Sided	Open: 26" l x 11" w x 25" h Closed: 26" l x 11" w	15.0 lb	Open: 66 cm x 27.9 cm x 63.5 cm Closed: 66 cm x 27.9 cm	6.8 kg	6
New! ES 1867506	GRAY	Executive Series™ Floor Sign with Multilingual “Caution” Imprint, 2-Sided	Open: 26" l x 11" w x 25" h Closed: 26" l x 11" w	15.0 lb	Open: 66 cm x 27.9 cm x 63.5 cm Closed: 66 cm x 27.9 cm	6.8 kg	6
FG611277	YEL	Floor Sign with “Caution Wet Floor” Imprint, 2-Sided	Open: 26" l x 11" w x 25" h Closed: 26" l x 11" w	15.0 lb	Open: 66 cm x 27.9 cm x 63.5 cm Closed: 66 cm x 27.9 cm	6.8 kg	6
FG611278	YEL	Floor Sign with Multilingual “Closed” Imprint, 2-sided	Open: 26" l x 11" w x 25" h Closed: 26" l x 11" w	15.0 lb	Open: 66 cm x 27.9 cm x 63.5 cm Closed: 66 cm x 27.9 cm	6.8 kg	6
FG611400	YEL	Floor Sign with Multilingual “Caution” Imprint, 4-Sided	Open: 38" l x 12" w x 37" h Closed: 38" l x 12" w	26.9 lb	Open: 96.5 cm x 30.5 cm x 94 cm Closed: 96.5 cm x 30.5 cm	12.2 kg	6
New! ES 1867509	BLACK	Executive Series™ Floor Sign with Multilingual “Caution” Imprint, 4-Sided	Open: 38" l x 12" w x 37" h Closed: 38" l x 12" w	26.9 lb	Open: 96.5 cm x 30.5 cm x 94 cm Closed: 96.5 cm x 30.5 cm	12.2 kg	6
New! ES 1867510	GRAY	Executive Series™ Floor Sign with Multilingual “Caution” Imprint, 4-Sided	Open: 38" l x 12" w x 37" h Closed: 38" l x 12" w	26.9 lb	Open: 96.5 cm x 30.5 cm x 94 cm Closed: 96.5 cm x 30.5 cm	12.2 kg	6
FG611477	YEL	Floor Sign with “Caution Wet Floor” Imprint, 4-Sided	Open: 38" l x 12" w x 37" h Closed: 38" l x 12" w	26.9 lb	Open: 96.5 cm x 30.5 cm x 94 cm Closed: 96.5 cm x 30.5 cm	12.2 kg	6
FG611478	YEL	Floor Sign with Multilingual “Closed” Imprint, 4-Sided	Open: 38" l x 12" w x 37" h Closed: 38" l x 12" w	26.9 lb	Open: 96.5 cm x 30.5 cm x 94 cm Closed: 96.5 cm x 30.5 cm	12.2 kg	6
FG618400	YEL	20' (6.1 m) Barrier Chain for FG611400 and Safety Cones	0.25" dia x 20' l x 0.88" w	5.2 lb	0.6 cm dia x 50.8 cm x 2.2 cm	2.4 kg	4

*Applies to yellow signs only. Executive Series™ gray and black Caution Signs are NOT compliant with OSHA nor ANSI colors or graphics.

*Custom imprinting available; contact Rubbermaid Customer Service for details.

**ANSI Z535.3–2002 Criteria for Safety Symbols; ANSI Z535–Safety Color; OSHA 1910.144–Safety Color; OSHA 1910.145–Specification for Accident Prevention Signage

WHEN ORDERING PRODUCTS WITH BOLD COLOR CODES, PLEASE SPECIFY COLOR CODE AFTER THE PRODUCT NUMBER. REFER TO THE PRODUCT COLOR GUIDE AT THE BACK OF THE CATALOG.



Check out the items marked with this symbol for our new line of Executive Series™ products.

Wooden Safety Signs

2-sided hinged Caution signs.

- Dark hardwood frame for added elegance
- Durable plastic feet help protect wood finish from spills
- Hinged top with integrated carry handle for easy transport and storage
- Available with gold or silver triligual Caution plate



ES 1867507



ES 1867508

No.	Color	Description	U.S. Dimensions	U.S. Ship Wt/Ctn	Metric Dimensions	Metric Ship Wt/Ctn	Pack
New! ES 1867507	GOLD	Executive Series™ Series™ Floor Sign with Multilingual "Caution" Imprint, 2-Sided	Open: 22" l x 15 1/8" w x 20" d Closed: 23 3/4" l x 15 1/8" w x 2 1/4" d	13.5 lb	Open: 55.9 cm x 38.4 cm x 50.8 cm Closed: 60.3 cm x 38.4 cm x 5.7 cm	6.2 kg	1
New! ES 1867508	SILVER	Executive Series™ Series™ Floor Sign with Multilingual "Caution" Imprint, 2-Sided	Open: 22" l x 15 1/8" w x 20" d Closed: 23 3/4" l x 15 1/8" w x 2 1/4" d	TBA	Open: 55.9 cm x 38.4 cm x 50.8 cm Closed: 60.3 cm x 38.4 cm x 5.7 cm	6.2 kg	1

Mobile Barrier

Easy to use, highly visible mobile barrier for use in many situations.

- Flexible panels allow straight, curved, and circular configurations
- Extends to 13' when fully opened; locking straps keep barrier closed when not in use
- Lightweight and compact (2' x 13" footprint when closed)
- ANSI- and OSHA-compliant color and graphics**
- For indoor use; shipped assembled



FG9S1100

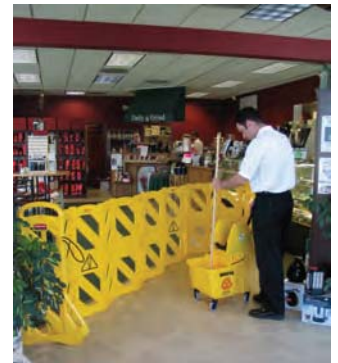

WORK AROUND ELECTRICAL EQUIPMENT?

Excerpt from OSHA reg. 29 CFR 1910.335 (b)(2): "Barricades shall be used...to prevent or limit employee access to work areas...Conductive [metal] barricades may not be used where they might cause an electrical contact hazard."

No.	Color	Description	U.S. Dimensions	U.S. Ship Wt/Ctn	Metric Dimensions	Metric Ship Wt/Ctn	Pack
FG9S1100	YEL	Mobile Barrier	Open: 40" h x 13' l x 1" w Closed: 40" h x 2' l x 13" w	37.0 lb	Open: 101.6 cm x 396 cm x 2.54 cm Closed: 101.6 cm x 61.0 cm x 33.0 cm	16.8 kg	1

**ANSI Z535.3–2002 Criteria for Safety Symbols; ANSI Z535–Safety Color; OSHA 1910.144–Safety Color; OSHA 1910.145–Specification for Accident Prevention Signage

Cone Barrier System

Complete, expandable system for quick deployment.

- FG628700 includes:
 - One 36" four-sided FG627600 Safety Cone
 - One steel double weight ring (27.2 lbs)
 - One belt cassette (7 ft x 3 in)
 - ANSI- and OSHA-compliant color and graphics**
 - Expand the system with additional FG628700 units
 - Stackable and can be used with Square BRUTE® Dolly (FG353000) for easy transport



FG628700 (2 qty.)



No.	Color	Description	U.S. Dimensions	U.S. Ship Wt/Ctn	Metric Dimensions	Metric Ship Wt/Ctn	Pack
FG353000	BLA	BRUTE® Square Dolly for FG352600, FG353600 Containers	17.25" sq x 6.25" h	18.5 lb	43.8 cm sq x 15.9 cm	8.4 kg	2
FG628700	YEL	Cone Barricade System Consists of FG627600, (1) Belt Cassette, and (1) Double Weight Ring	12.25" l x 12.25" w x 39.75" h	27.2 lb	31.1 cm x 31.1 cm x 101 cm	12.3 kg	1

Pop-Up Safety Cones

Collapsible, automatically deployable cone.

- Durable cone material withstands rough handling
- Wall-mounted, shatterproof storage tube provides easy and compact storage
- Storage tube mounting hardware includes tape and screws
- ANSI- and OSHA-compliant color and graphics**



FG9S0000



No.	Color	Description	U.S. Dimensions	U.S. Ship Wt/Ctn	Metric Dimensions	Metric Ship Wt/Ctn	Pack
FG9S0000	YEL	Pop-Up Safety Cone, 20" (50.8 cm) with Multilingual "Caution" Imprint and Wet Floor Symbol	21" dia x 21" w x 20" h	12.7 lb	53.3 cm dia x 53.3 cm x 50.8 cm	5.8 kg	12
FG9S0100	YEL	Pop-Up Safety Cone, 30" (76.2 cm) with Multilingual "Caution" Imprint and Wet Floor Symbol	21" dia x 21" w x 30" h	23.5 lb	53.3 cm dia x 53.3 cm x 76.2 cm	10.7 kg	12

Folding Safety Cones

Large cone folds with a simple twist and slides into compact shell for handy storage.

- Made of spring steel and durable, easy-clean fabric
- Highly visible—30% more surface area than competitive fabric safety cones
- Large when deployed; compact when folded and stored in shell
- Storage shell mounting hardware includes tape, strap, and screws
- ANSI- and OSHA-compliant color and graphics**

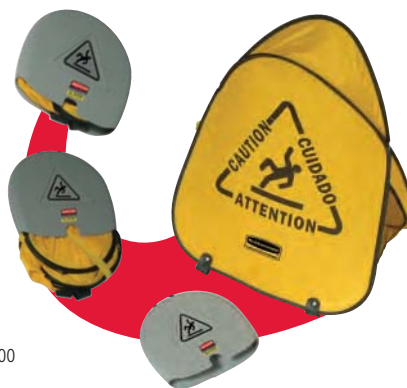

FG9S0700



No.	Color	Description	U.S. Dimensions	U.S. Ship Wt/Ctn	Metric Dimensions	Metric Ship Wt/Ctn	Pack
FG9S0700	YEL	Folding Safety Cone with "Caution" Imprint, English, Spanish, French	Opened: 20" h x 18 1/2" w x 13" d Closed: 8" h x 8" w x 1 1/2" d Shell: 9" h x 8 3/4" w x 1 1/2" d	16.5 lb	Opened: 50.8 cm x 46.6 cm x 33.0 cm Closed: 20.3 cm x 20.3 cm x 3.81 cm Shell: 20.3 cm x 22.2 cm x 4.44 cm	7.5 kg	12
FG9S0725	YEL	Folding Safety Cone with International Wet Floor Symbol	Opened: 20" h x 18 1/2" w x 13" d Closed: 8" h x 8" w x 1 1/2" d Shell: 9" h x 8 3/4" w x 1 1/2" d	16.5 lb	Opened: 50.8 cm x 46.6 cm x 33.0 cm Closed: 20.3 cm x 20.3 cm x 3.81 cm Shell: 20.3 cm x 22.2 cm x 4.44 cm	7.5 kg	12

**ANSI Z535.3—2002 Criteria for Safety Symbols; ANSI Z535—Safety Color; OSHA 1910.144—Safety Color; OSHA 1910.145—Specification for Accident Prevention Signage

WHEN ORDERING PRODUCTS WITH BOLD COLOR CODES, PLEASE SPECIFY COLOR CODE AFTER THE PRODUCT NUMBER. REFER TO THE PRODUCT COLOR GUIDE AT THE BACK OF THE CATALOG.



Check out the items marked with this symbol for our new line of Executive Series™ products.

Safety Cones and Accessories

Highly visible, bright yellow hazard protection system.

- Versatile top design accommodates barricade belt, flashing light, lock-in sign holder, and Audio Guard® accessories
- Four-sided shape for efficient stacking
- Multilingual imprinted warning messages provide effective communication with a broad audience
- Molded-in slots for easy handling
- Can be used with Square BRUTE® Dolly (FG353000) for easy transport
- ANSI- and OSHA-compliant color and graphics**



No.	Color	Description	U.S. Dimensions	U.S. Ship Wt/Ctn	Metric Dimensions	Metric Ship Wt/Ctn	Pack
FG353000	BLA	BRUTE® Square Dolly for FG352600, FG353600 Containers	17.25" sq x 6.25" h	18.5 lb	43.8 cm sq x 15.9 cm	8.4 kg	2
FG618400	YEL	20' (6.1 m) Barrier Chain for FG611400 and Safety Cones	0.25" dia x 20' l x 0.88" w	5.2 lb	0.6 cm dia x 50.8 cm x 2.2 cm	2.4 kg	4
FG627600*	YEL	Safety Cone 36" (91.4 cm) with Multilingual "Caution" Imprint	12.25" l x 12.25" w x 36" h	17.6 lb	31.1 cm x 31.1 cm x 91.4 cm	8 kg	5
FG627677	YEL	Safety Cone 36" (91.4 cm) with Multilingual "Caution Wet Floor" Imprint	12.25" l x 12.25" w x 36" h	17.6 lb	31.1 cm x 31.1 cm x 91.4 cm	8 kg	5
FG627687	YEL	Safety Cone 36" (91.4 cm) with Multilingual "Caution Safety First" Imprint	12.25" l x 12.25" w x 36" h	17.6 lb	31.1 cm x 31.1 cm x 91.4 cm	8 kg	5
FG627700*	YEL	Safety Cone 25.75" (65.4 cm) with Multilingual "Caution" Imprint	10.5" l x 10.5" w x 25.75" h	14.0 lb	26.7 cm x 26.7 cm x 65.4 cm	6.4 kg	6
FG627777	YEL	Safety Cone 25.75" (65.4 cm) with Multilingual "Caution Wet Floor" Imprint	10.5" l x 10.5" w x 25.75" h	14.0 lb	26.7 cm x 26.7 cm x 65.4 cm	6.4 kg	6
FG628400	BLA	Weight Ring – Single for all 36" (91.4 cm) Safety Cones	12.5" l x 12.5" w x 1" h	10.0 lb	31.8 cm x 31.8 cm x 2.5 cm	4.5 kg	1
FG628600	BLA	Lock-In Sign Holder for 25 1/2" (65.4 cm) and 36" (91.4 cm) Safety Cones	6" l x 0.75" w x 1.88" h	2.7 lb	15.2 cm x 1.9 cm x 4.8 cm	1.2 kg	12
FG628700	YEL	Cone Barricade System Consists of FG627600, (1) Belt Cassette, and (1) Double Weight Ring	12.25" l x 12.25" w x 39.75" h	27.2 lb	31.1 cm x 31.1 cm x 101 cm	12.3 kg	1

*Custom imprinting available; contact Rubbermaid Customer Service for details.

Site Safety Hanging Signs

Sign and pole combination for blocking doorways and entrances.

- Twisting action secures pole in doorways up to 50" wide to prohibit entry
- Soft, pliable sign rolls around pole for easy storage
- ANSI- and OSHA-compliant color and graphics**



FG9S1600

No.	Color	Description	U.S. Dimensions	U.S. Ship Wt/Ctn	Metric Dimensions	Metric Ship Wt/Ctn	Pack
FG9S1500	YEL	Site Safety Hanging Sign with "Closed for Cleaning" Imprint – English Only	Closed: 13" h x 28" w x 1" d Open: 13" h x 50 1/2" w x 1" d	5.5 lb	33 cm x 71.12 cm x 2.5 cm 33 cm x 127.6 cm x 2.5 cm	2.5 kg	6
FG9S1600	YEL	Site Safety Hanging Sign with Multilingual "Closed for Cleaning" Imprint	Closed: 13" h x 27 3/4" w x 1" d Open: 13" h x 50" w x 1" d	5.5 lb	33 cm x 70.5 cm x 2.5 cm 33 cm x 127 cm x 2.5 cm	2.5 kg	6

**ANSI Z535.3–2002 Criteria for Safety Symbols; ANSI Z535–Safety Color; OSHA 1910.144–Safety Color; OSHA 1910.145–Specification for Accident Prevention Signage

The Importance of Safety to Businesses

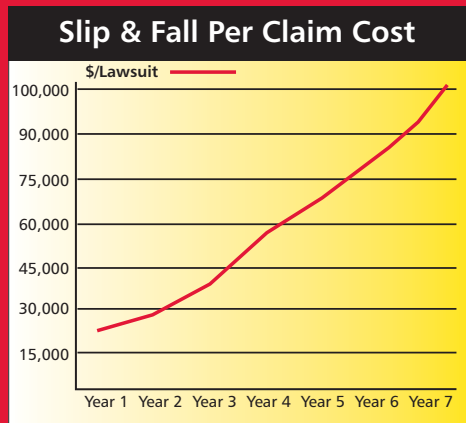

Every year, slip, trip, and fall accidents cost U.S. businesses over \$100,000 per lawsuit.

Source: Nat'l Floor Safety Institute (NFSI)

Hanging Safety Sign

An essential safety sign for use in stairways and doors.

- Flexible locking hanger keeps sign in place
- Two-sided design meets OSHA requirements
- ANSI- and OSHA-compliant color and graphics**



Flexible locking-style hanger helps keep sign in place.



FG611000



No.	Color	Description	U.S. Dimensions	U.S. Ship Wt/Ctn	Metric Dimensions	Metric Ship Wt/Ctn	Pack
FG611000*	YEL	Hanging Safety Sign with Multilingual "Caution" Imprint and Falling Person Symbol	19.5" l x 4.375" w	3.0 lb	49.53 cm x 11.1 cm	1.4 kg	6

*Custom imprinting available; contact Rubbermaid Customer Service for details.

**ANSI Z535.3—2002 Criteria for Safety Symbols; ANSI Z535—Safety Color; OSHA 1910.144—Safety Color; OSHA 1910.145—Specification for Accident Prevention Signage

WHEN ORDERING PRODUCTS WITH BOLD COLOR CODES, PLEASE SPECIFY COLOR CODE AFTER THE PRODUCT NUMBER. REFER TO THE PRODUCT COLOR GUIDE AT THE BACK OF THE CATALOG.



Check out the items marked with this symbol for our new line of Executive Series™ products.

Over-the-Spill® System
Slip-resistant pads quickly cover spills and alert pedestrians.

- Each yellow pad is coded with universal caution symbol and "Caution Wet Floor" message in English and Spanish
- Dispensing station mounts on flat surfaces
- Pads absorb up to 12 oz of liquid for faster clean-up
- ANSI- and OSHA-compliant color and graphics**



FG425100



FG425500



FG425400



FG425400 on FG611200

No.	Color	Description	U.S. Dimensions	U.S. Ship Wt/Ctn	Metric Dimensions	Metric Ship Wt/Ctn	Pack
FG425100	YEL	Over-the-Spill® Station Kit includes Pad Dispenser, 25 Large Pads, and Fasteners	21" l x 17.75" w	14.0 lb	53.3 cm x 45.1 cm	6.4 kg	6
FG425200	YEL	Over-the-Spill® Station Pads, Large; Refill Pads for FG425100, Contains 25 Pads	20" l x 16.5" w	25.0 lb	50.8 cm x 41.9 cm	11.3 kg	12
FG425300	YEL	Over-the-Spill® Station Pads, Medium; Refill Pads for FG425100, Contains 25 Pads	16.5" l x 14" w	17.0 lb	41.9 cm x 35.6 cm	7.7 kg	12
FG425400	YEL	Over-the-Spill® Pad Tablet; Contains 25 Pads	16.5" l x 14" w	20.0 lb	41.9 cm x 35.6 cm	9.1 kg	12
FG425500	YEL	Over-the-Spill® Mini Tablet	17" l x 7" w x 1.25" h	8.7 lb	43.2 cm x 17.8 cm x 3.2 cm	3.9 kg	12



FG425100 / FG425400

**ANSI Z535.3–2002 Criteria for Safety Symbols; ANSI Z535–Safety Color; OSHA 1910.144–Safety Color; OSHA 1910.145–Specification for Accident Prevention Signage



Smarter Foodservice

Our Commitment to You

At Rubbermaid Commercial Products, we're passionate about foodservice. We understand that food freshness and overall quality are the key ingredients you need to create and execute an exceptional experience for your customer. As the industry leader in innovative, solutions-based commercial products, our broader mission is to provide meaningful and smart solutions to meet all of your operational needs. Our commitment to you is to provide an array of innovative solutions to help you succeed in your goal of creating the highest-quality experience for your guests at the lowest overall cost to you.

Our Commitment to Safety

You can depend on Rubbermaid's patent-pending designs and award-winning products to help you meet industry standards for preparing, serving, storing, and transporting food safely.

Our Commitment to Sustainability

Rubbermaid Commercial Products is committed to products, methods, and programs that help people live and work in more environmentally sustainable ways. All RCP products marked with the leaf symbol indicate products specifically designed to support sustainable business practices and/or contain post-consumer recycled content—one more way Rubbermaid Commercial Products helps you Work Smarter every day.

SPECIAL ORDER SMALLWARES

The **SPECIAL ORDER SMALLWARES (S.O.S.)** Program is designed to bring you more flexibility in accessing our foodservice products. For small fees, you have the option of no minimum order, drop ship to your customer, and/or rush order requests. Look for the SOS logo next to qualifying products throughout this catalog.

- **Small Order:** Orders less than \$200 will be charged a \$5 handling fee with freight added
- **Drop Ship:** All orders will have freight added
- **Express:** All rush orders will be charged a \$10 handling fee with freight added, only parcel shipments qualify for Express
- **Standard Orders:** Orders \$4,500 and above qualify for prepaid freight for RCP standard carrier
- **Break Case:** Available on qualifying products, charged \$5 per line item

Please contact your Rubbermaid Foodservice Sales Representative or Customer Service for more information.

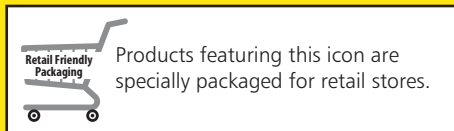

Visit www.rubbermaidcommercial.com for more information.

BPA-Free. Extreme Performance.



The foodservice industry's first-ever BPA-Free commercial product line

Developed in partnership with Eastman Tritan™, the new BPA-free foodservice product line upholds Rubbermaid Commercial's highest durability and quality standards, while also providing customers with sustainable, wellness-oriented solutions.

With a wide range of foodservice solutions, from food pans to storage containers to beverage servers, Rubbermaid Commercial's BPA-free line has everything you need for measuring, storing, and serving.



**Cold and Heavy-Duty
Hot Food Pans**



**Scoops and
Measuring Cups**



Beverage Service

FOOD STORAGE

ProServe® Ingredient Management System –Bins and Lids	250
Racks for Shelf Ingredient Bins.....	251
Dunnage Racks.....	251
ProServe® Ingredient Management System –Containers and Sliding Lids	252
Material and Product Selection Guide	253
ProSave® Dual-Action Food Box Lids	254
Food Box Accessories.....	254
Food Boxes.....	255
Space-Saving Square Containers and Lids	256
Premier Small-Capacity Containers.....	257
Round Storage Containers and Lids	257
Cold Food Pans.....	258
Heavy-Duty Hot Food Pans	258

FOOD PREPARATION

High-Heat Scrapers and Spoons.....	260
Cold Scrapers and Spoons	260
Measuring Cups and Spoons	260
Bouncer® Measuring Cups	261
Bouncer® Portioning Scoops.....	261
Bouncer® Scoops.....	261
BRUTE® GreensKeeper® Containers	262
Cake Keeper	262
BRUTE® "ICE ONLY" Container	262

MONITORING SOLUTIONS

Premium Digital Portion Control Scales	264
Pizza Scale Kit for Premium Digital Scales	264
High-Performance Digital Portion Control Scales.....	264
Compact Digital Portion Control Scales	265
Accessories for Digital Scales	265
Baker's Beam Scales	265
Portion Control Scales, Mechanical	266
Scales, Washable	266
Y-Line Mechanical Portion Control Scales ..	267
Compact Portion Control Scales	267
Hanging Scales	267
Digital Receiving/Utility Scales	268
Briefcase/Utility Mechanical Receiving Scales	268
Platform Receiving Scales	268
Thermocouples	269
Infrared Thermometer.....	270
Digital Thermometers	270
Dial Pocket Thermometer.....	270
Equipment-Monitoring Thermometer	271
Food Preparation Thermometer	271
Timers	271

FOOD TRANSPORT

ProServe® Ice Handling System.....	272
ProServe® Lightweight Insulated Carriers ..	273
ProServe® Professional Delivery Bags.....	274
CaterMax™ Insulated Carriers	274
ProServe® Sheet Pan Rack System.....	275
ProServe® Racks and Carts.....	275
Convertible Utility Cart.....	276
Executive Service Cart.....	277
Service Carts.....	277
Xtra™ Carts.....	278
Heavy-Duty Utility Carts.....	278
Heavy-Duty Platform Truck.....	279
Triple® Trolley.....	279
Stack & Nest Palletote® Boxes	279

BEVERAGE AND TABLE SERVICE

Bus/Tote Boxes.....	280
Cutlery Bin.....	280
Condiment Dispensers	280
Bouncer® Pitchers	281
Covered Pitchers	281
Beverage Dispensers.....	281
Insulated Cold Beverage Dispensers	281

YOUTH SERVICE

Sturdy Chair™ Youth Seats with Microban® Antimicrobial Protection	282
Baby Changing Stations with Antimicrobial Protection.....	283

Foodservice

ProSave® Ingredient Management System

INGREDIENT BINS

Improved productivity through integrated lid and scoop system.

- Integrated lid and measuring scoop allows for quick one-handed access to stored ingredients
- Clear window for fast ingredient identification and inventory management
- Certified to NSF/ANSI/3-A and 2 Standards
- Commercial dishwasher-safe
- Complies with FDA Food code 3-304.12 to increase inspection score

SHELF INGREDIENT BINS (additional features)

The only storage system to access ingredients when stacked.

- One-handed access while stacked improves space efficiency
- FIFO (First In First Out) barrier for proper food rotation improves food quality



Dedicated internal scoop storage meets safety compliance.



Speed up food preparation with one-handed access.



Ensures proper food rotation with FIFO barrier.

55%

PRODUCTIVITY SAVINGS

with one-handed access



SCOOPS INCLUDED WITH BINS!



FG9G6000
40 Cups
13 lbs flour



FG9G5700
100 Cups
25 lbs flour



FG9G5800
200 Cups
50 lbs flour



FG360088
400 Cups
124 lbs flour



FG360288
500 Cups
154 lbs flour



FG360388
600 Cups
188 lbs flour

PROSAVE® INGREDIENT BINS



No.	Color	Description	U.S. Capacity (gal/cu. ft)	U.S. Flour/Sugar Capacity	Dimensions	U.S. Ship Wt/Ctn	Metric Capacity	Metric Flour/Sugar Capacity	Metric Dimensions	Metric Ship Wt/ Ctn	Pack
FG9G6000	WHT	40-Cup Shelf Ingredient Bin with 1/2-Cup Scoop	2.63 gal .33 cu ft	Flour: 13 lb Sugar: 17 lb	15" l x 11.75" w x 8.5" h	3.30 lbs	.12 m ³	Flour: 5.90 kg Sugar: 7.71 kg	38.1 cm x 29.8 cm x 21.6 cm	1.5 kg	1
FG9G5700	WHT	100-Cup Shelf Ingredient Bin with 2-Cup Scoop	6.25 gal .836 cu ft	Flour: 25 lb Sugar: 50 lb	23.5" l x 11.5" w x 16.88" h	13.25 lbs	.08 m ³	Flour: 11.34 kg Sugar: 22.68 kg	59.7 cm x 29.2 cm x 42.9 cm	6.01 kg	1
FG9G5800	WHT	200-Cup Shelf Ingredient Bin with 2-Cup Scoop	12.63 gal 1.67 cu ft	Flour: 50 lb Sugar: 100 lb	23.5" l x 19.2" w x 16.88" h	18.5 lbs	.10 m ³	Flour: 22.68 kg Sugar: 45.36 kg	59.7 cm x 48.8 cm x 42.9 cm	8.39 kg	1
FG360088	WHT	Slant-Front Ingredient Bin with Sliding Lid and 32-oz (0.9-L) Scoop	20.5 gal 2.75 cu ft	Flour: 124 lb Sugar: 158 lb	29.25" l x 13.13" w x 28" h	27.7 lb	.08 m ³	Flour: 56.3 kg Sugar: 72.7 kg	74.3 cm x 33.4 cm x 71.1 cm	12.6 kg	1
FG360100	WHT	Flat-Top Ingredient Bin with Sliding Hinged Lid	28 gal 3.75 cu ft	Flour: 139 lb Sugar: 178 lb	22" l x 22" w x 23" h	29.1 lb	.11 m ³	Flour: 63.1 kg Sugar: 80.8 kg	55.9 cm x 55.9 cm x 58.4 cm	13.2 kg	1
FG360288	WHT	Slant-Front Ingredient Bin with Sliding Lid and 32-oz (0.9-L) Scoop	26.2 gal 3.5 cu ft	Flour: 154 lb Sugar: 197 lb	29.5" l x 15.5" w x 28" h	32.7 lb	.1 m ³	Flour: 69.9 kg Sugar: 89.4 kg	74.9 cm x 39.4 cm x 71.1 cm	14.8 kg	1
FG360388	WHT	Slant-Front Ingredient Bin with Sliding Lid and 32-oz (0.9-L) Scoop	30.8 gal 4.12 cu ft	Flour: 188 lb Sugar: 240 lb	29.75" l x 18" w x 28" h	38.7 lb	.12 m ³	Flour: 85.3 kg Sugar: 108.9 kg	75.6 cm x 45.7 cm x 71.1 cm	17.6 kg	1

PROSAVE® LIDS WITH SCOOPS



No.	Color	Description	U.S. Dimensions	Fits Rubbermaid® Ingredient Bin	U.S. Ship Wt/Ctn	Metric Dimensions	Metric Ship Wt/Ctn	Pack
FG9F7700	CLR	Sliding Lid with 32-oz (0.9-L) Scoop for FG360088 Ingredient Bin	29" l x 12.1" w x 1.9" h	FG360088	5.8 lb	73.7 cm x 30.7 cm x 4.8 cm	2.6 kg	1
FG9F7800	CLR	Sliding Lid with 32-oz (0.9-L) Scoop for FG360288 Ingredient Bin	29" l x 14.5" w x 1.9" h	FG360288	6.5 lb	73.7 cm x 36.8 cm x 4.8 cm	2.9 kg	1
FG9F7900	CLR	Sliding Lid with 32-oz (0.9-L) Scoop for FG360388 Ingredient Bin	29" l x 17.2" w x 1.9" h	FG360388	7.4 lb	73.7 cm x 43.7 cm x 4.8 cm	3.4 kg	1

WHEN ORDERING PRODUCTS WITH **BOLD** COLOR CODES, PLEASE SPECIFY COLOR CODE AFTER THE PRODUCT NUMBER. REFER TO THE PRODUCT COLOR GUIDE AT THE BACK OF THE CATALOG.

Racks for Shelf Ingredient Bins

Store and transport bins efficiently throughout the operation.

- Maximize space for kitchen preparation and storeroom for ingredient storage
- Racks designed to hold and transport 200 lbs. (90.7 kg) per shelf
- 5" nonmarking casters for safe transport
- Locating bar on shelf to secure bins during transport
- Customize your shelf ingredient bins in storage with different configurations

SCOOPS INCLUDED WITH BINS!



FG9G8100
Rack
Wall-Mounted



FG9G5900
Rack
26" Wide



FG9G7900
Rack
38" Wide



FG9G8000
Rack
50" Wide

RACKS FOR PROSAVE® SHELF INGREDIENT BINS

No.	Color	Description	U.S. Depth	U.S. Width	U.S. Height	Case Weight (lbs)	Metric Depth	Metric Width	Metric Height	Case Weight (kg)	Case Pack
FG9G5900	CHRM	Cart for Shelf Ingredient Bins	18"	26"	47.75"	37.5 lbs	45.7 cm	66 cm	121.3 cm	17 kg	1
FG9G7900	CHRM	Mobile Rack for Shelf Ingredient Bins, 38" wide	18"	38"	48.276"	43.8 lbs	35.6 cm	96.5 cm	122.6 cm	19.9 kg	1
FG9G8000	CHRM	Mobile Rack for Shelf Ingredient Bins, 50" wide	18"	50"	67.157"	76 lbs	45.7 cm	127 cm	170.5 cm	34.5 kg	1
FG9G8100	CHRM	Wall-Mounted Rack for Shelf Ingredient Bin (FG9G6000 only)	10.5"	10.63"	7.13"	5.2 lbs	26.7 cm	27 cm	18.1 cm	2.4 kg	2

SCOOPS



No.	Color	Description	Cups (Liters)	U.S. Depth	U.S. Width	U.S. Height	Case Weight (lbs)	Metric Depth	Metric Width	Metric Height	Case Weight (kg)	Case Pack
FG9G8200 ^a	WHT	½ Cup Measuring Scoop for FG9G6000 Shelf Ingredient Bin	½ Cup (0.12 L)	7.38"	3.38"	1.50"	1.05 lbs	18.7 cm	8.6 cm	3.8 cm	.48 kg	12
FG9F7500 ^a	CLR	BOUNCER® Contour Scoop for FG360088, FG360288, FG360388 Ingredient Bins and FG9G7700	32 oz (0.95 L)	10.8"	4.8"	4.7"	4.2 lbs	27.4 cm	12.2 cm	12 cm	1.9 kg	6
FG9F7600 ^a	CLR	BOUNCER® Contour Scoop for FG360088, FG360288, FG360388 Ingredient Bins and FG9G7800	64 oz (1.90 L)	13.44"	5.89"	6.0"	6.2 lbs	34.1 cm	15 cm	15.2 cm	2.8 kg	6
FG9G5100 ^a	CLR	BOUNCER® Portioning Scoop for FG9G5700, FG9G5800 Shelf Ingredient Bins and FG9G7600, FG9G7300	2 Cups (0.47 L)	4.6"	5.1"	5.25"	3.2 lbs	11.7 cm	13 cm	13.3 cm	1.4 kg	12
FG9G5200 ^a	CLR	BOUNCER® Portioning Scoop for FG9G7700, FG9G7400 Sliding Lid	3 Cups (0.71 L)	6"	5.1"	5.70"	4.0 lbs	15.2 cm	13 cm	14.5 cm	1.8 kg	12
FG9G5300 ^a	CLR	BOUNCER® Portioning Scoop for FG9G7800, FG9G7500 Sliding Lid	4 Cups (0.95 L)	6"	5.60"	6.60"	5.0 lbs	15.2 cm	14.2 cm	16.8 cm	2.3 kg	12

^aCertified to NSF Std. 2.

Dunnage Racks

Perfect for storing frozen, cold, or dry goods off of the floor.

- Slotted deck allows maximum air circulation for perishable or dry goods



MEETS NSF FOOD SAFETY GUIDELINES

12" high deck meets food safety guidelines; NSF-approved.

FG449100

FREEZER-SAFE

Withstands temperatures from -20°F to 120°F.

RUGGED CONSTRUCTION

Duramold's™ exclusive, precision-engineered resin and rust-resistant aluminum composite structure provides maximum load support.



No.	Color	Description	U.S. Dimensions	U.S. Capacity	U.S. Ship Wt/Ctn	Metric Dimensions	Metric Capacity	Metric Ship Wt/Ctn	Pack
FG448900	BLA	Dunnage Rack (24" x 36")	35.9" l x 24.25" w x 12.5" h	1500 lb	28.0 lb	91.2 cm x 61.6 cm x 31.8 cm	680 kg	12.7 kg	1
FG449000	BLA	Dunnage Rack (24" x 48")	47.88" l x 24.25" w x 12.5" h	2000 lb	35.0 lb	121.6 cm x 61.6 cm x 31.8 cm	907 kg	15.9 kg	1
FG449100	BLA	Dunnage Rack (30" x 60")	59.9" l x 30.25" w x 12.5" h	2000 lb	44.0 lb	152.1 cm x 76.8 cm x 31.8 cm	907 kg	20 kg	1

ProSave® Ingredient Management System

SLIDING LID FOR BRUTE® INGREDIENT CONTAINERS
 Designed for quick one-handed access to ingredients in a high-production facility.

- Rotating lid allows for one-handed access
- Dedicated internal scoop storage complies with food code for safe access
- Hook options for 32- and 64-oz. Contour Scoop allows for ingredient access flexibility
- Clear windows for fast ingredient identification and inventory management
- Certified to NSF/ANSI/3-A and 2 Standards
- Commercial dishwasher-safe



Improve safety compliance with dedicated internal scoop storage.



Enhance food production efficiency with rotating clear lid.



FG264000
Dolly



**PROSAVE®
FOOD BOX
SYSTEM ON
PAGE 254.**

**SCOOPS
INCLUDED!**



FG9G7600 /
FG9G7700 /
FG9G7800
Sliding Lid



FG9G7300
100 Cups
25 lbs flour



FG9G7400
250 Cups
75 lbs flour



FG9G7500
400 Cups
125 lbs flour

PROSAVE® INGREDIENT CONTAINER LIDS



No.	Color	Description	Depth	Width	Height	Case Weight (lbs to kg)	Case Pack
FG9G7600	WHT	Sliding Lid with 2-Cup Scoop (fits FG261000 BRUTE® Container)	17"	17"	4.75"	3.04 lbs (1.38 kg)	1
FG9G7700	WHT	Sliding Lid with 3-Cup Scoop (fits FG262000 BRUTE® Container)	20.75"	20.75"	5"	4.30 lbs (1.95 kg)	1
FG9G7800	WHT	Sliding Lid with 4-Cup Scoop (fits FG263200 BRUTE® Container)	23.50"	23.50"	5.25"	5.25 lbs (2.38 kg)	1

PROSAVE® INGREDIENT CONTAINER COMBOS



No.	Color	Description	Gallons (Liters)	Cups (Liters)	Cubic ft ³ (Meters m ³)	Flour lbs (kg)	Sugar lbs (kg)	Depth	Width	Height	Case Weight (lbs to kg)	Case Pack
FG9G7300	WHT	Sliding Lid w/ 2-Cup Scoop and FG261000 BRUTE® Container COMBO	6.70 (25.36)	100 (23.66)	.90 (15)	33 (15)	46 (21)	16.90"	16.90"	18.90"	7.92 lbs (3.59 kg)	1
FG9G7400	WHT	Sliding Lid w/ 3-Cup Scoop and FG262000 BRUTE® Container COMBO	15.60 (59.05)	250 (59.15)	2.09 (0.06)	78 (35)	109 (49)	20.90"	20.90"	24.80"	10.65 lbs (4.83 kg)	1
FG9G7500	WHT	Sliding Lid w/ 4-Cup Scoop and FG263200 BRUTE® Container COMBO	25.60 (96.90)	400 (94.64)	3.42 (0.10)	128 (58)	178 (81)	23.40"	23.40"	29.30"	14.05 lbs (6.37 kg)	1

PROSAVE® INGREDIENT CONTAINERS



No.	Color	Description	Gallons (Liters)	Cups (Liters)	Cubic ft ³ (Meters m ³)	Flour lbs (kg)	Sugar lbs (kg)	Depth	Width	Height	Case Weight (lbs to kg)	Case Pack
FG261000	WHT	BRUTE® Container without Lid	10 (37.85)	150 (35.49)	1.33 (0.04)	47 (21)	65 (29)	15.63"	15.63"	17.13"	19 lbs (8.62 kg)	6
FG262000	WHT	BRUTE® Container without Lid	20 (75.70)	300 (70.98)	2.66 (0.08)	94 (43)	130 (59)	19.50"	19.50"	22.88"	35 lbs (15.88 kg)	6
FG263200	WHT	BRUTE® Container without Lid	32 (121.12)	500 (118.29)	4.28 (0.12)	156 (71)	217 (98)	22"	22"	27.25"	49.5 lbs (22.45 kg)	6
FG264000	BLA	BRUTE® Dolly for FG9G7400, FG9G7500, FG262000, and FG263200						18.25"	18.25"	6.63"	13.1 lbs (5.94 kg)	2

WHEN ORDERING PRODUCTS WITH BOLD COLOR CODES, PLEASE SPECIFY COLOR CODE AFTER THE PRODUCT NUMBER. REFER TO THE PRODUCT COLOR GUIDE AT THE BACK OF THE CATALOG.



MATERIAL AND PRODUCT SELECTION GUIDE

Rubbermaid, the leader in food storage, understands the complexity of your business and the multitude of challenges you face on a daily basis managing food costs, time, and labor issues. We offer a wide selection of storage containers in different materials to allow you to choose the right storage container for your operational needs.



PROSAVE® INGREDIENT BINS

Dry Bulk Food Storage

- Sliding lids and integrated scoops allow for ease of access to ingredients for preparation efficiency
- Promotes food safety compliance



PROSAVE® FOOD BOX SYSTEM

Dry or Refrigerated Bulk Food Storage

- Efficiently stores and transports bulk foods
- Clarity allows for product identification for easier inventory control and ordering
- Also available in polyethylene



SPACE-SAVING SQUARE CONTAINERS

Prepared Food Storage

- 25% more space-efficient than round containers
- Containers have color-imprinted measurements for preparation and inventory management
- Available in clear and polypropylene



ROUND CONTAINERS

Prepared Food Storage

- Economical, durable, and easy to use
- Round design for improved air circulation during storage
- Available in polypropylene and polyethylene



COLD & HEAVY-DUTY HOT FOOD PANS

Full-Service Containers

- Streamlines operation for storage, preparation, cooking, and serving
- Four lid options available to meet process needs
- Available in high heat (Amber) and clear material



PREMIER® CONTAINERS

Small-Capacity Storage

- Secure space-efficient storage for small ingredients and spices
- Stores from 2 to 14 cups

MATERIAL SELECTION GUIDE

	High-Heat Material	Crystal-Clear Material	Polyethylene	Clarified Polypropylene
Temperature	■ Temperature Rated: -40°F to 375°F (-40°C to 190°C)	■ Temperature Rated: -40°F to 212°F (-40°C to 100°C)	■ Temperature Rated: -20°F to 150°F (-29°C to 66°C)	■ Temperature Rated: -20°F to 150°F (-29°C to 66°C)
Washing	■ Commercial dishwasher-safe ■ Approved for use in continuous motion pot-washing systems	■ Commercial dishwasher-safe	■ Commercial dishwasher-safe	■ Commercial dishwasher-safe
Cooking	■ Microwave-safe ■ Steam table well-safe ■ Oven safe up to 375°F (190°C) ■ Not for use with open flame	■ Not for use in steam table wells	Not rated	Not rated
Cooling	■ Cooling and heating rate comparable to stainless steel ■ Cooler to the touch than metal	■ Cooling rate comparable to stainless steel	Not rated	Not rated
Surface	■ Smooth surfaces are easy to clean ■ Stain-, odor-, and break-resistant ■ Nonstick surface for better food release	■ Smooth surfaces are easy to clean ■ Stain-, odor-, and break-resistant ■ Nonstick surface for better food release	■ Smooth surfaces are easy to clean ■ White, transparent ■ Strong, impact resistance	■ Smooth surfaces are easy to clean ■ Contact clear, translucent ■ Good impact resistance
Certification	■ FDA food grade materials ■ NSF-Certified ■ EU-Certified	■ FDA food grade materials ■ NSF-Certified ■ EU-Certified	■ FDA food grade materials ■ NSF-Certified ■ EU-Certified	■ FDA food grade materials ■ NSF-Certified ■ EU-Certified

ProSave® Dual-Action Food Box Lids

Designed with you in mind, the Prosave® Dual-Action Food Box lid helps provide an integrated solution that not only fits all clear food boxes, but slides back or flips up for proper food storage and freshness, saving you time and money.

- Access food contents without having to remove the lid
- Universal lid fits competitive clear food boxes
- Door slides back or flips up for flexible access
- Reinforced lid corners for durability
- Simple disassembly for commercial dishwashing



Food Box Accessories

Improve productivity and space efficiency.

DRAIN TRAYS

- Domed design allows for improved drainage to keep food fresh longer
- Improves airflow circulation
- 2 sizes to fit both 12" x 18" and 18" x 26" food boxes



COLANDERS

- Easy lift handles (8" only)
- Promotes liquid drainage
- Available in 5" or 8" depth for 18" x 26" clear food boxes



65%

PRODUCTIVITY SAVINGS

with one-handed access



FG330500 / FG331100



FG331400 / FG331800



FG330300

PROSAVE® DUAL-ACTION LIDS



No.	Color	Description	U.S. Dimensions	U.S. Ship Wt/Ctn	Metric Dimensions	Metric Ship Wt/Ctn	Case Pack
FG330500	CLR	Prosave® Dual-Action Lid*	18" l x 12" w	4.06 lbs	45.7 cm l x 30.5 cm w	1.84 kg	3
FG331100	CLR	Prosave® Dual-Action Lid*	26" l x 18" w	8.13 lbs	66 cm l x 45.7 cm w	3.69 kg	3

*Fits clear food boxes

DRAIN TRAYS



No.	Color	Description	U.S. Dimensions	U.S. Ship Wt/Ctn	Metric Dimensions	Metric Ship Wt/Ctn	Case Pack
FG331400	CLR	Drain Tray	18" l x 12" w	3.5 lbs	45.7 cm l x 30.5 cm w	1.59 kg	6
FG331800	CLR	Drain Tray	26" l x 18" w	2.9 lbs	66 cm l x 45.7 cm w	1.32 kg	6

COLANDERS



No.	Color	Description	U.S. Dimensions	U.S. Ship Wt/Ctn	Metric Dimensions	Metric Ship Wt/Ctn	Case Pack
FG330300	CLR	Colander for Tote Boxes 6" deep or greater	26" l x 18" w x 5" d	26.7 lbs	66 cm l x 45.7 cm w x 12.7 cm d	12.21 kg	6

WHEN ORDERING PRODUCTS WITH **BOLD** COLOR CODES, PLEASE SPECIFY COLOR CODE AFTER THE PRODUCT NUMBER. REFER TO THE PRODUCT COLOR GUIDE AT THE BACK OF THE CATALOG.

Food Boxes

Durable storage solution for food as it flows throughout your facility.

- Crystal-clear material is stain- and odor-resistant and allows for visibility of food contents and quality
- White polypropylene containers provide durable and practical solution
- Texturing on corners and base reduces scratching
- Labeling window visible on bases and lids for date and information coding
- Available in standard sizes of 18" x 12" and 26" x 18"

SOLID FLAT LIDS

- Durable lids snap tightly into place during transport and keep foods fresh
- Use lid as a tray when displayed upside down
- Available in crystal-clear material or white polyethylene



FG330000 and F330200



FG330600
FG330800
FG330000
FG332800
FG330100



FG350400
FG350800
FG350000
FG352800
FG350100

CRYSTAL-CLEAR FOOD BOXES AND LIDS



No.	Color	Description	U.S. Capacity	U.S. Dimensions	U.S. Ship Wt/Ctn	Metric Capacity	Metric Dimensions	Metric Ship Wt/Ctn	Case Pack
FG330600	CLR	Food/Tote Box	5 gal	26" l x 18" w x 3.5" d	21.5 lbs	18.9 L	66 cm x 45.7 cm x 8.9 cm	9.8 kg	6
FG330800	CLR	Food/Tote Box	8½ gal	26" l x 18" w x 6" d	30.0 lbs	32.2 L	66 cm x 45.7 cm x 15.2 cm	13.6 kg	6
FG330000	CLR	Food/Tote Box	12½ gal	26" l x 18" w x 9" d	42.9 lbs	47.3 L	66 cm x 45.7 cm x 22.9 cm	19.5 kg	6
FG332800	CLR	Food/Tote Box	16½ gal	26" l x 18" w x 12" d	54.9 lbs	62.9 L	66 cm x 45.7 cm x 30.5 cm	24.9 kg	6
FG330100	CLR	Food/Tote Box	21½ gal	26" l x 18" w x 15" d	66.9 lbs	81.4 L	66 cm x 45.7 cm x 38.1 cm	30.3 kg	6
FG330200	CLR	Lid for FG330000, FG330100, FG330600, FG330800, FG332800 Food/Tote Boxes	N/A	26" l x 18" w	16.9 lbs	N/A	66 cm x 45.7 cm	7.7 kg	6
FG330700	CLR	Food/Tote Box	2 gal	18" l x 12" w x 3.5" d	10.4 lbs	7.6 L	45.7 cm x 30.5 cm x 8.9 cm	4.7 kg	6
FG330900	CLR	Food/Tote Box	3½ gal	18" l x 12" w x 6" d	18.0 lbs	13.2 L	45.7 cm x 30.5 cm x 15.2 cm	8.2 kg	6
FG330400	CLR	Food/Tote Box	5 gal	18" l x 12" w x 9" d	22.1 lbs	18.9 L	45.7 cm x 30.5 cm x 22.9 cm	10 kg	6
FG331000	CLR	Lid for FG330400, FG330700, FG330900 Food/Tote Boxes	N/A	18" l x 12" w	7.6 lbs	N/A	45.7 cm x 30.5 cm	3.4 kg	6

POLYETHYLENE FOOD BOXES* AND LIDS



No.	Color	Description	U.S. Capacity	U.S. Dimensions	U.S. Ship Wt/Ctn	Metric Capacity	Metric Dimensions	Metric Ship Wt/Ctn	Case Pack
FG350600	WHT	Food/Tote Box	5 gal	26" l x 18" w x 3.5" d	18.1 lbs	18.9 L	66 cm x 45.7 cm x 8.9 cm	8.2 kg	6
FG350800	WHT	Food/Tote Box	8½ gal	26" l x 18" w x 6" d	23.3 lbs	32.2 L	66 cm x 45.7 cm x 15.2 cm	10.5 kg	6
FG350000	WHT	Food/Tote Box	12½ gal	26" l x 18" w x 9" d	31.7 lbs	47.3 L	66 cm x 45.7 cm x 22.9 cm	14.4 kg	6
FG352800	WHT	Food/Tote Box	16½ gal	26" l x 18" w x 12" d	41.8 lbs	62.9 L	66 cm x 45.7 cm x 30.5 cm	19 kg	6
FG350100	WHT	Food/Tote Box	21½ gal	26" l x 18" w x 15" d	52.9 lbs	81.4 L	66 cm x 45.7 cm x 38.1 cm	24 kg	6
FG350200	WHT	Lid for FG350000, FG350100, FG350600, FG350800, FG352800 Food/Tote Boxes	N/A	26" l x 18" w	14.8 lbs	N/A	66 cm x 45.7 cm	6.7 kg	6
FG350700	WHT	Food/Tote Box	2 gal	18" l x 12" w x 3.5" d	8.2 lbs	7.6 L	45.7 cm x 30.5 cm x 8.9 cm	3.7 kg	6
FG350900	WHT	Food/Tote Box	3½ gal	18" l x 12" w x 6" d	14.0 lbs	13.2 L	45.7 cm x 30.5 cm x 15.2 cm	6.4 kg	6
FG350400	WHT	Food/Tote Box	5 gal	18" l x 12" w x 9" d	17.2 lbs	18.9 L	45.7 cm x 30.5 cm x 22.9 cm	7.8 kg	6
FG351000	WHT	Lid for FG350400, FG350700, FG350900 Food/Tote Boxes	N/A	18" l x 12" w	7.1 lbs	N/A	45.7 cm x 30.5 cm	3.2 kg	6

*Does not work with ProSave® Dual-Action Lids.

Space-Saving Square Containers

Stackable containers store more in less space.

- Square containers store a minimum of 25% more on a shelf than round containers
- Available in break-resistant, crystal-clear material for visibility or durable white polyethylene
- Manage food inventory with easy-to-read measurement graduations—red for quarts and blue for liters
- Durable handles for easy transport and drain holes for proper washing and drying
- Temperature range for clear containers: -40°F to 212°F (-40°C to 100°C)
- Temperature range for white containers: -20°F to 150°F (-29°C to 66°C)
- Assists in complying with HACCP guidelines
- NSF 3-A Meat and Poultry Equipment and NSF 2-certified
- Commercial dishwasher-safe

Lids

- Snap-tight fit reduces leakage, helps prevent spoilage, and limits cross-contamination
- Corner pull tab for easy lid removal
- Lids available in two sizes to fit all containers, eliminating the need for multiple lids
- Leak-resistant, secure lids



Polycarbonate Square Storage Containers



FG650900 / FG630200

FG650900 / FG630400

FG650900 / FG630600

FG650900 / FG630800

FG652300 / FG631200

FG652300 / FG631800

FG652300 / FG632200

CRYSTAL-CLEAR SQUARE STORAGE CONTAINERS



No.	Color	Description	U.S. Capacity	U.S. Dimensions	U.S. Ship Wt/Ctn	Metric Capacity	Metric Dimensions	Metric Ship Wt/Ctn	Case Pack
FG630200	CLR	Space-Saving Square Container	2 qt	8.75" l x 8.8" w x 2.69" h	7.03 lbs	1.9 L	22.2 cm x 22.4 cm x 6.8 cm	3.2 kg	12
FG630400	CLR	Space-Saving Square Container	4 qt	8.75" l x 8.8" w x 4.75" h	10.44 lbs	3.8 L	22.2 cm x 22.4 cm x 12.1 cm	4.7 kg	12
FG630600	CLR	Space-Saving Square Container	6 qt	8.75" l x 8.8" w x 6.94" h	14.06 lbs	5.7 L	22.2 cm x 22.4 cm x 17.6 cm	6.4 kg	12
FG630800	CLR	Space-Saving Square Container	8 qt	8.75" l x 8.8" w x 8.75" h	9.415 lbs	7.6 L	22.2 cm x 22.4 cm x 22.2 cm	4.3 kg	6
FG631200	CLR	Space-Saving Square Container	12 qt	11.31" l x 10.5" w x 7.75" h	10.97 lbs	11.4 L	28.7 cm x 26.7 cm x 19.7 cm	5 kg	6
FG631800	CLR	Space-Saving Square Container	18 qt	11.31" l x 10.5" w x 11.94" h	17.22 lbs	17 L	28.7 cm x 26.7 cm x 30.3 cm	7.8 kg	6
FG632200	CLR	Space-Saving Square Container	22 qt	11.31" l x 10.5" w x 14.44" h	22.96 lbs	20.8 L	28.7 cm x 26.7 cm x 36.7 cm	10.4 kg	6

POLYETHYLENE SQUARE STORAGE CONTAINERS



No.	Color	Description	U.S. Capacity	U.S. Dimensions	U.S. Ship Wt/Ctn	Metric Capacity	Metric Dimensions	Metric Ship Wt/Ctn	Case Pack
FG9F0300	WHT	Space-Saving Square Container	2 qt	8.75" l x 8.8" w x 2.69" h	5.8 lbs	1.89 L	22.2 cm x 22.4 cm x 6.8 cm	2.6 kg	12
FG9F0400	WHT	Space-Saving Square Container	4 qt	8.75" l x 8.8" w x 4.75" h	8.2 lbs	3.79 L	22.2 cm x 22.4 cm x 12.1 cm	3.7 kg	12
FG9F0500	WHT	Space-Saving Square Container	6 qt	8.75" l x 8.8" w x 6.94" h	11.0 lbs	5.68 L	22.2 cm x 22.4 cm x 17.6 cm	5.0 kg	12
FG9F0600	WHT	Space-Saving Square Container	8 qt	8.75" l x 8.8" w x 8.75" h	7.2 lbs	7.57 L	22.2 cm x 22.4 cm x 22.2 cm	3.3 kg	6
FG9F0700	WHT	Space-Saving Square Container	12 qt	11.31" l x 10.5" w x 7.75" h	8.6 lbs	11.3 L	28.7 cm x 26.7 cm x 19.7 cm	3.9 kg	6
FG9F0800	WHT	Space-Saving Square Container	18 qt	11.31" l x 10.5" w x 11.94" h	14.6 lbs	17 L	28.7 cm x 26.7 cm x 30.3 cm	6.6 kg	6
FG9F0900	WHT	Space-Saving Square Container	22 qt	11.31" l x 10.5" w x 14.44" h	18.8 lbs	20.8 L	28.7 cm x 26.7 cm x 36.7 cm	8.5 kg	6

SQUARE STORAGE CONTAINER LIDS



No.	Color	Description	U.S. Dimensions	U.S. Ship Wt/Ctn	Metric Dimensions	Metric Ship Wt/Ctn	Case Pack
FG650900	WHT	Lid for FG630200, FG630400, FG630600, FG630800, FG9F0300, FG9F0400, FG9F0500, FG9F0600 Space-Saving Containers	8.75" l x 8.31" w	2.99 lbs	22.2 cm x 21.1 cm	1.4 kg	12
FG652300	WHT	Lid for FG631200, FG631800, FG632200, FG9F0700, FG9F0800, FG9F0900 Space-Saving Containers	11.31" l x 10.5" w	2.45 lbs	28.7 cm x 26.7 cm	1.1 kg	6

WHEN ORDERING PRODUCTS WITH BOLD COLOR CODES, PLEASE SPECIFY COLOR CODE AFTER THE PRODUCT NUMBER. REFER TO THE PRODUCT COLOR GUIDE AT THE BACK OF THE CATALOG.

Premier Small-Capacity Containers

Space-efficient storage for small ingredients and spices.

- Resists stains, odors, and breakage
- Lids snap to base and to their lids for easy storage (lid is included)
- NSF-certified* and commercial dishwasher-safe



PREMIER SMALL-CAPACITY STORAGE



No.	Color	Description	U.S. Capacity	U.S. Dimensions	U.S. Ship Wt/Ctn	Metric Capacity	Metric Dimensions	Metric Ship Wt/Ctn	Case Pack
FG7H75TR*	CHILI	Premier Small-Capacity Storage w/ Lid	2 cup	5.06" sq x 3.38" h	3.51 lbs	.47 L	12.9 cm sq x 8.6 cm	1.59 kg	8
FG7H76TR*	CHILI	Premier Small-Capacity Storage w/ Lid	3 cup	7.13" sq x 2.5" h	2.93 lbs	.71 L	18.1 cm sq x 6.4 cm	1.34 kg	6
FG7H77TR*	CHILI	Premier Small-Capacity Storage w/ Lid	5 cup	7.13" sq x 3.56" h	3.37 lbs	1.18 L	18.1 cm sq x 9 cm	1.53 kg	6
FG7H78TR*	CHILI	Premier Small-Capacity Storage w/ Lid	9 cup	9.44" sq x 3.31" h	3.57 lbs	2.13 L	24 cm sq x 8.4 cm	1.62 kg	4
FG7H79TR*	CHILI	Premier Small-Capacity Storage w/ Lid	14 cup	9.44" sq x 4.88" h	4.37 lbs	3.31 L	24 cm sq x 12.4 cm	1.98 kg	4

*NSF restrictions for lid pertaining to some fatty food types. Visit www.nfs.org for more information.

Round Storage Containers

Store food safely and efficiently.

- Stackable handled containers available in white polyethylene or semi-clear polypropylene for better visibility
- Temperature range: 35°F to 150°F (2°C to 66°C)
- NSF 3-A and NSF 2-certified
- Dishwasher-safe



FG572200 / FG572024

FG572200 / FG572100

FG572500 / FG572324

FG572500 / FG572400

FG573000 / FG572824

FG573000 / FG572900

Lids

- Positive-lock lids (double wall seal) with corner pull tabs for keeping foods fresh
- Lids available in three sizes to fit all containers, eliminating the need for multiple lids
- Leak-resistant, secure lids

SEMI-CLEAR POLYPROPYLENE ROUND STORAGE CONTAINERS



No.	Color	Description	U.S. Capacity	U.S. Dimensions	U.S. Ship Wt/Ctn	Metric Capacity	Metric Dimensions	Metric Ship Wt/Ctn	Case Pack
FG572024	CLR	Round Storage Container	2 qt	8.5" dia x 4" h	4.3 lbs	1.9 L	21.6 cm dia x 10.2 cm	2 kg	12
FG572124	CLR	Round Storage Container	4 qt	8.5" dia x 7.75" h	7.4 lbs	3.8 L	21.6 cm dia x 19.7 cm	3.4 kg	12
FG572324	CLR	Round Storage Container	6 qt	10" dia x 7.63" h	8.7 lbs	5.7 L	25.4 cm dia x 19.4 cm	3.9 kg	12
FG572424	CLR	Round Storage Container	8 qt	10" dia x 10.63" h	11.9 lbs	7.6 L	25.4 cm dia x 27 cm	5.4 kg	12
FG572624	CLR	Round Storage Container	12 qt	13.13" dia x 8.13" h	8.5 lbs	11.4 L	33.3 cm dia x 20.6 cm	3.9 kg	6
FG572724	CLR	Round Storage Container	18 qt	13.13" dia x 11.88" h	11.6 lbs	17 L	33.3 cm dia x 30.2 cm	5.3 kg	6
FG572824	CLR	Round Storage Container	22 qt	13.13" dia x 14" h	14.8 lbs	20.8 L	33.3 cm dia x 35.6 cm	6.7 kg	6
FG572924	CLR	Round Storage Container with Bail	22 qt	13.13" dia x 14" h	15.9 lbs	20.8 L	33.3 cm dia x 35.6 cm	7.2 kg	6

POLYETHYLENE ROUND STORAGE CONTAINERS



No.	Color	Description	U.S. Capacity	U.S. Dimensions	U.S. Ship Wt/Ctn	Metric Capacity	Metric Dimensions	Metric Ship Wt/Ctn	Case Pack
FG572000	WHT	Round Storage Container	2 qt	8.5" dia x 4" h	4.3 lbs	1.9 L	21.6 cm dia x 10.2 cm	2 kg	12
FG572100	WHT	Round Storage Container	4 qt	8.5" dia x 7.75" h	7.4 lbs	3.8 L	21.6 cm dia x 19.7 cm	3.4 kg	12
FG572300	WHT	Round Storage Container	6 qt	10" dia x 7.63" h	8.7 lbs	5.7 L	25.4 cm dia x 19.4 cm	3.9 kg	12
FG572400	WHT	Round Storage Container	8 qt	10" dia x 10.63" h	11.9 lbs	7.6 L	25.4 cm dia x 27 cm	5.4 kg	12
FG572600	WHT	Round Storage Container	12 qt	13.13" dia x 8.13" h	8.5 lbs	11.4 L	33.3 cm dia x 20.6 cm	3.9 kg	6
FG572700	WHT	Round Storage Container	18 qt	13.13" dia x 11.88" h	11.6 lbs	17 L	33.3 cm dia x 30.2 cm	5.3 kg	6
FG572800	WHT	Round Storage Container	22 qt	13.13" dia x 14" h	15.2 lbs	20.8 L	33.3 cm dia x 35.6 cm	6.9 kg	6
FG572900	GRAY, WHT	Round Storage Container with Bail	22 qt	13.13" dia x 14" h	16.6 lbs	20.8 L	33.3 cm dia x 35.6 cm	7.5 kg	6

ROUND STORAGE CONTAINER LIDS



No.	Color	Description	U.S. Dimensions	U.S. Ship Wt/Ctn	Metric Dimensions	Metric Ship Wt/Ctn	Case Pack
FG572200	YEL, NAT	Lid for FG572000, FG572024, FG572100, FG572124 Round Storage Containers	8.75" dia x 0.88" h	2.6 lbs	22.2 cm dia x 2.2 cm	1.2 kg	12
FG572500	YEL, NAT	Lid for FG572300, FG572324, FG572400, FG572424 Round Storage Containers	10.25" dia x 1" h	3.6 lbs	26 cm dia x 2.5 cm	1.6 kg	12
FG573000	YEL, NAT	Lid for FG572600, FG572624, FG572700, FG572724, FG572800, FG572824, FG572900, FG572924 Round Storage Containers	13" dia x 2.75" h	3.7 lbs	34.3 cm dia x 7 cm	1.7 kg	6

Cold and Heavy-Duty Hot Food Pans

Streamline your operations for storage, preparation, cooking, and serving.

- Break-resistant – won't rust, dent, or bend
- Odor-resistant
- Stain-resistant
- Nonstick surfaces for easy food release and cleaning
- FDA-approved for food contact
- NSF/ANSI/3-A and 2-Certified
- EU-Certified
- Designed to EN 631-1 C.E.N. Standard*
- Soft-sealing and secure sealing lids are temperature rated from -20°F to 150°F (-29°C to 66°C)
- Dishwasher-safe



Cold Food Pans

- Temperature Rated: -40°F to 212°F (-40°C to 100°C)
- Not for use in steam table wells

Heavy-Duty Hot Food Pans

- Temperature Rated: -40°F to 375°F (-40°C to 191°C)
- Steam table well-, oven-** and microwave-safe
- Not for use with open flame
- Cooler to the touch than metal
- Approved for use in continuous motion pot-washing systems



Hot pans are cool to the touch.



Nonstick surfaces for easy food release and cleaning.

LIDS FOR EVERY NEED

1 SECURE-SEALING LID

Two-seal system makes this lid the most airtight of all the Rubbermaid options and is ideal for longer-term storage or air-sensitive foods. Easy-grip tab allows for easy removal of the lid from the pan.

2 PEG HOLE COVER WITH HANDLE

Peg hole allows pan to be hung and dry faster, helping to prevent health risks from standing water. Rubbermaid's peg hole solution is the only NSF-certified hanging solution on the market.

3 NOTCHED COVER WITH HANDLE

NSF-certified notch allows spoon to be easily available while food remains covered. Notch keeps spoon handle out of food, complying with FDA Food Code.

4 SOFT-SEALING LID

Seals on insert pan help reduce airflow to food, therefore maintaining food quality. No overlap on food pans allows easy use in transport.

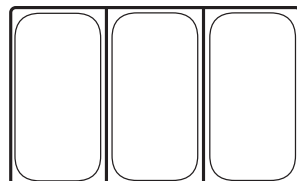

**Oven-safe up to 375°F (191°C).

***DESIGNED TO EN 631-1 C.E.N. STANDARD**
 Developed by the European Committee for Standardization and based on a gastronorm modular system, ensures compatibility of the pans with other kitchen equipment.



FG117P00 Clear



FG217P00 Amber



FG217P00 Black



FOOD PANS

COLD PANS

HOT PANS

U.S. Size	U.S. Pan Depth/Description	U.S. Capacity	U.S. Ship Wt/Ctn	Metric Size	Metric Pan Depth	Metric Capacity	Metric Ship Wt/Ctn	Case Pack	Item Number	Color	Item Number	Color
Full Size 20 1/4" l x 12 1/4" w 	2 1/2"	9 qt	12.8 lbs	Full Size	65 mm	8.5 L	5.8 kg	6	FG130P00	CLR	FG230P00	BLA, AMBER
	4"	13 3/4 qt	17.87 lbs	530 mm x 325 mm	100 mm	13 L	3.6 kg	6	FG131P00	CLR	FG231P00	BLA, AMBER
	6"	20 3/4 qt	20.30 lbs	N/A	150 mm	19.5 L	9.2 kg	6	FG132P00	CLR	FG232P00	AMBER
	8"	27 1/2 qt	24.52 lbs	N/A	200 mm	25.7 L	11.1 kg	6	FG133P00	CLR	N/A	N/A
	Handled Cover	N/A	10.21 lbs	N/A	N/A	N/A	4.6 kg	6	FG134P00	CLR	FG234P00	AMBER
	Handled Notched Cover	N/A	9.37 lbs	N/A	N/A	N/A	4.3 kg	6	FG134P86	CLR	FG234P86	AMBER
	Secure-Sealing Lid	N/A	14.5 lbs	N/A	N/A	N/A	6.6 kg	12	FG135P29	GRAY	N/A	N/A
Soft-Sealing Lid	N/A	12.13 lbs	N/A	N/A	N/A	5.5 kg	12	FG147P00	WHT	N/A	N/A	
1/2 Size LONG 20 1/4" l x 6 3/8" w 	2 1/2"	3 3/4 qt	8.33 lbs	1/2 Size LONG	65 mm	3.4 L	3.8 kg	6	FG139P00	CLR	FG239P00	BLA, AMBER
	4"	5 1/2 qt	9.40 lbs	530 mm x 162 mm	100 mm	5.2 L	4.3 kg	6	FG140P00	CLR	FG241P00	AMBER
	Handled Cover	N/A	4.77 lbs	N/A	N/A	N/A	2.2 kg	6	FG141P00	CLR	N/A	N/A
1/2 Size 12 1/4" l x 10 3/8" w 	2 1/2"	4 qt	6.30 lbs	1/2 Size	65 mm	3.8 L	2.9 kg	6	FG123P00	CLR	FG223P00	BLA, AMBER
	4"	6 3/4 qt	7.65 lbs	325 mm x 265 mm	100 mm	6 L	3.5 kg	6	FG124P00	CLR	FG224P00	BLA, AMBER
	6"	9 1/2 qt	9.90 lbs	N/A	150 mm	8.8 L	4.5 kg	6	FG125P00	CLR	FG225P00	BLA, AMBER
	8"	11 3/4 qt	13.47 lbs	N/A	200 mm	10.8 L	6.1 kg	6	FG126P00	CLR	N/A	N/A
	Drain Tray	N/A	2.0 lbs	N/A	N/A	N/A	0.9 kg	6	FG127P24 ⁴	CLR	FG127P00	AMBER
	Handled Cover w/ Peg Hole	N/A	4.3 lbs	N/A	N/A	N/A	2 kg	6	FG128P23	CLR	FG228P23	AMBER
	Handled Notched Cover	N/A	4.3 lbs	N/A	N/A	N/A	2 kg	6	FG128P86	CLR	FG228P86	AMBER
Secure-Sealing Lid	N/A	7.1 lbs	N/A	N/A	N/A	3.2 kg	12	FG129P29	GRAY	N/A	N/A	
Soft-Sealing Lid	N/A	6.75 lbs	N/A	N/A	N/A	3.1 kg	12	FG146P00	WHT	N/A	N/A	
1/2 Size 20 1/4" l x 6 3/8" w 	2 1/2"	2 3/4 qt	4.40 lbs	1/2 Size	65 mm	2.5 L	2 kg	6	FG116P00	CLR	FG216P00	BLA, AMBER
	4"	4 qt	5.50 lbs	325 mm x 176 mm	100 mm	3.8 L	2.5 kg	6	FG117P00	CLR	FG217P00	BLA, AMBER
	6"	5 3/4 qt	7.30 lbs	N/A	150 mm	5.1 L	3.3 kg	6	FG118P00	CLR	FG218P00	BLA, AMBER
	8"	7 3/4 qt	9.60 lbs	N/A	200 mm	7 L	4.4 kg	6	FG119P00	CLR	FG219P00	BLA, AMBER
	Drain Tray	N/A	1.50 lbs	N/A	N/A	N/A	0.7 kg	6	FG120P24 ⁴	CLR	N/A	N/A
	Handled Cover w/ Peg Hole	N/A	2.77 lbs	N/A	N/A	N/A	1.3 kg	6	FG121P23	CLR	FG120P00	AMBER
	Handled Notched Cover w/ Peg Hole	N/A	3.10 lbs	N/A	N/A	N/A	1.4 kg	6	FG121P86	CLR	FG221P23	AMBER
Secure-Sealing Lid	N/A	4.5 lbs	N/A	N/A	N/A	2.0 kg	12	FG122P29	GRAY	FG221P86	AMBER	
Soft-Sealing Lid	N/A	3.75 lbs	N/A	N/A	N/A	1.7 kg	12	FG145P00	WHT	N/A	N/A	
1/4 Size 10 3/8" l x 6 3/8" w 	2 1/2"	1 3/4 qt	3.4 lbs	1/4 Size	65 mm	1.6 L	1.5 kg	6	FG110P00	CLR	FG210P00	BLA, AMBER
	4"	2 1/2 qt	4.4 lbs	265 mm x 162 mm	100 mm	2.4 L	2 kg	6	FG111P00	CLR	FG211P00	BLA, AMBER
	6"	4 qt	5.6 lbs	N/A	150 mm	3.8 L	2.5 kg	6	FG112P00	CLR	FG212P00	BLA, AMBER
	Drain Tray	N/A	0.9 lbs	N/A	N/A	N/A	0.4 kg	6	FG113P24	CLR	FG113P00	AMBER
	Handled Cover	N/A	2.1 lbs	N/A	N/A	N/A	1 kg	6	FG114P00	CLR	FG214P00	AMBER
	Handled Notched Cover	N/A	2.1 lbs	N/A	N/A	N/A	1 kg	6	FG114P86	CLR	FG214P86	AMBER
	Secure-Sealing Lid	N/A	3 lbs	N/A	N/A	N/A	1.3 kg	12	FG115P29	GRAY	N/A	N/A
Soft-Sealing Lid	N/A	2.54 lbs	N/A	N/A	N/A	1.2 kg	12	FG144P00	WHT	N/A	N/A	
1/6 Size 6 3/8" l x 6 3/8" w 	2 1/2"	1 1/4 qt	2.57 lbs	1/6 Size	65 mm	1.1 L	1.2 kg	6	FG104P00	CLR	FG204P00	BLA, AMBER
	4"	1 3/4 qt	3.0 lbs	176 mm x 162 mm	100 mm	1.6 L	1.4 kg	6	FG105P00	CLR	FG205P00	BLA, AMBER
	6"	2 1/2 qt	3.9 lbs	N/A	150 mm	2.4 L	1.8 kg	6	FG106P00	CLR	FG206P00	BLA, AMBER
	Drain Tray	N/A	N/A	N/A	N/A	N/A	N/A	N/A	N/A	N/A	FG345600	AMBER
	Handled Cover w/ Peg Hole	N/A	1.47 lbs	N/A	N/A	N/A	0.7 kg	6	FG108P23	CLR	FG208P23	AMBER
	Handled Notched Cover w/ Peg Hole	N/A	1.5 lbs	N/A	N/A	N/A	0.7 kg	6	FG108P86	CLR	FG208P86	AMBER
	Secure-Sealing Lid	N/A	2.1 lbs	N/A	N/A	N/A	0.9 kg	12	FG109P29	GRAY	N/A	N/A
Soft-Sealing Lid	N/A	3 lbs	N/A	N/A	N/A	1.4 kg	12	FG143P00	WHT	N/A	N/A	
1/6 Size 6 3/8" l x 4 3/8" w 	2 1/2"	3/4 qt	2 lbs	1/6 Size	65 mm	.6 L	0.9 kg	6	FG100P00	CLR	FG200P00	AMBER
	4"	3/4 qt	2.19 lbs	176 mm x 108 mm	100 mm	.8 L	1 kg	6	FG101P00	CLR	FG201P00	BLA, AMBER
	Cover w/ Peg Hole	N/A	0.87 lbs	N/A	N/A	N/A	0.4 kg	6	FG102P23	CLR	FG202P23	AMBER
	Notched Cover	N/A	0.90 lbs	N/A	N/A	N/A	0.4 kg	6	FG102P86	CLR	N/A	N/A
	Secure-Sealing Lid	N/A	1.5 lbs	N/A	N/A	N/A	0.7 kg	12	FG103P29	GRAY	N/A	N/A
	Soft-Sealing Lid	N/A	1.2 lbs	N/A	N/A	N/A	0.5 kg	12	FG142P00	WHT	N/A	N/A

⁴FG127P24 fits all but FG126P00 ⁴FG120P24 fits all but FG119P00

High-Heat Scrapers and Spoons

All-purpose scrapers and spatulas are a necessity in every kitchen.

- Silicone blade and nylon handle resist temperatures to 500°F/260°C and help prevent burns
- Clean-Rest™ feature keeps blade off countertops, reducing cross-contamination
- Notched scraper blade cleanly scrapes sides of pans
- Blades are stain-resistant and will not scratch pans
- NSF-certified and commercial dishwasher-safe



■ Clean-Rest™ reduces risk of cross-contamination.



Scraper

Spoon



No.	Color	Description	U.S. Dimensions	U.S. Ship Wt/Ctn	Metric Dimensions	Metric Ship Wt/Ctn	Case Pack
FG196200	0000	High-Heat Scraper	9.5" l	4.09 lbs	24.1 cm	1.9 kg	24
FG196300	0000	High-Heat Scraper	13.5" l	5.77 lbs	34.3 cm	2.6 kg	24
FG196400	0000	High-Heat Scraper	16.5" l	7.03 lbs	41.9 cm	3.2 kg	24
FG196600	RED	High-Heat Spoon Scraper	9.5" l	3.31 lbs	24.1 cm	1.5 kg	24
FG196700	RED	High-Heat Spoon Scraper	13.5" l	6.58 lbs	34.3 cm	3 kg	24
FG196800	RED	High-Heat Spoon Scraper	16.5" l	7.11 lbs	41.9 cm	3.2 kg	24

Cold Scrapers and Spoons

Spoon, scrape, and spread with one easy tool.

- Blades are molded into handles for seamless construction that reduces buildup of dirt and bacteria
- Clean-Rest™ feature keeps blade off countertops, reducing cross-contamination
- NSF-certified and commercial dishwasher-safe



■ Clean-Rest™ reduces risk of cross-contamination.



Scraper

Scraper-Icing

Spoon



No.	Color	Description	U.S. Dimensions	U.S. Ship Wt/Ctn	Metric Dimensions	Metric Ship Wt/Ctn	Case Pack
FG190100	0000	Scraper	9.5" l	4 lbs	24.1 cm	1.8 kg	36
FG190500	0000	Scraper	13.5" l	8 lbs	34.3 cm	3.6 kg	36
FG190600	0000	Scraper	16.5" l	12 lbs	41.9 cm	5.4 kg	36
FG191300	0000	Scraper-Icing Blade	9.5" l	4 lbs	24.1 cm	1.8 kg	36
FG193300	WHT	Spoon-Shaped Spatula	9.5" l	4.61 lbs	24.1 cm	2.1 kg	36
FG193400	WHT	Spoon-Shaped Spatula	13.5" l	9.22 lbs	34.3 cm	4.2 kg	36
FG193800	WHT	Spoon-Shaped Spatula	16.5" l	11.1 lbs	41.9 cm	5.0 kg	36

Measuring Cups and Spoons

- Made of FDA-compliant materials
- Capacities clearly engraved for easy identification
- Spoons are secured with detachable ring
- Accurate ingredient portioning to manage food costs
- Commercial dishwasher-safe



FG8316AS



FG8315AS



FG9G8200



No.	Color	Description	U.S. Capacity	U.S. Ship Wt/Ctn	Metric Ship Wt/Ctn	Case Pack
FG8315AS	WHT	Measuring Cup Set	Set includes: ¼, ½, 1, and 2 cups	2.15 lbs	0.45 kg	12
FG8316AS	WHT	Measuring Spoon Set	Set includes: ¼ tsp, ½ tsp, 1 tsp, 1 ½ tsp, and 2 tsp	1 lb	0.45 kg	12
FG9G8200	WHT	Measuring Scoop	½ cup	1.05 lbs	0.45 kg	12

WHEN ORDERING PRODUCTS WITH **BOLD** COLOR CODES, PLEASE SPECIFY COLOR CODE AFTER THE PRODUCT NUMBER. REFER TO THE PRODUCT COLOR GUIDE AT THE BACK OF THE CATALOG.

Bouncer® Measuring Cups

Manage costly ingredients.

- Accurately measure liquid or dry ingredients to help save on food costs
- Break-resistant, crystal-clear material is durable
- Temperature range: -40°F to 212°F (-40°C to 100°C)
- Metric measurements marked in blue and cup measurements marked in red for easy-to-read measurements
- NSF-certified and commercial dishwasher-safe



No.	Color	Description	U.S. Capacity	U.S. Ship Wt/Ctn	Metric Capacity	Metric Ship Wt/Ctn	Case Pack
FG321000	CLR	Bouncer® Measuring Cup	1 cup	2.0 lbs	0.2 L	0.9 kg	12
FG321500	CLR	Bouncer® Measuring Cup	1 pt	2.36 lbs	0.5 L	1.1 kg	6
FG321600	CLR	Bouncer® Measuring Cup	1 qt	3.30 lbs	0.9 L	1.5 kg	6
FG321700	CLR	Bouncer® Measuring Cup	2 qt	4.43 lbs	1.9 L	2.0 kg	6
FG321800	CLR	Bouncer® Measuring Cup	4 qt	10.0 lbs	3.8 L	4.5 kg	6

Bouncer® Portioning Scoops

Maintain food safety while managing food costs.

- Hybrid scoop and measuring cup allow for portioning or measuring milliliters, cups, or ounces
- Anti-roll design to reduce risk of the handle rolling into the food and posing a contamination risk
- Break-resistant, crystal-clear material is durable
- Permanent textured gradations for dry and liquid measurements
- FG9G5100 and FG9G5200 are designed to fit ProSave® Shelf Ingredient Bins (see *Foodservice: Food Storage*)
- NSF-certified and commercial dishwasher-safe



Nests for efficient storage.



No.	Color	Description	U.S. Capacity	U.S. Ship Wt/Ctn	Metric Capacity	Metric Ship Wt/Ctn	Case Pack
FG9G5100	CLR	Bouncer® Portioning Scoop – 2 Cup	2 cup/16 oz	3.2 lbs	500 ml	1.5 kg	12
FG9G5200	CLR	Bouncer® Portioning Scoop – 3 Cup	3 cup/24 oz	4.0 lbs	750 ml	1.8 kg	12
FG9G5300	CLR	Bouncer® Portioning Scoop – 4 Cup	4 cup/32 oz	5.0 lbs	1000 ml	2.3 kg	12
FG9G5400	CLR	Bouncer® Portioning Scoop – 8 Cup	8 cup/64 oz	4.0 lbs	2000 ml	1.8 kg	6

Bouncer® Scoops

Multi-purpose scoops for use throughout food service operations.

- Durable crystal-clear material (FG288200, FG288400, FG288600) or white polyethylene (FG288500) can be used for a variety of applications
- NSF-certified and commercial dishwasher-safe
- Bouncer® Contour Scoop (FG9F7500 & FG9F7600) is designed for the Prosave® Ingredient Bin System; the contoured design keeps hands away from food, reducing cross-contamination



FG9F7500 and FG9F7600 feature hooks for use with Prosave® Ingredient Bins

FG288400 / FG288200 / FG288600

No.	Color	Description	U.S. Capacity	U.S. Ship Wt/Ctn	Metric Capacity	Metric Ship Wt/Ctn	Case Pack
FG288200 ^a	CLR	Bouncer® Bar Scoop	6 oz	3.0 lbs	0.2 L	1.4 kg	12
FG288400 ^a	CLR	Bouncer® Utility Scoop	32 oz	6.4 lbs	0.9 L	2.9 kg	12
FG288500	WHT	Utility Scoop	64 oz	3.4 lbs	1.9 L	1.5 kg	6
FG288600 ^a	CLR	Bouncer® Utility Scoop	64 oz	5.1 lbs	1.9 L	2.3 kg	6
FG9F7500 ^a	CLR	Bouncer® Contour Scoop for FG360088, FG360288, FG360388 Ingredient Bins (32-oz scoop)	32 oz	4.2 lbs	0.9 L	1.9 kg	6
FG9F7600 ^a	CLR	Bouncer® Contour Scoop for FG360088, FG360288, FG360388 Ingredient Bins (64-oz scoop)	64 oz	6.2 lbs	1.9 L	2.8 kg	6

^aCertified to NSF Std. 2.

BRUTE® GreensKeeper® Containers

For cleaning and storing any fruit or vegetable.

- All-in-one wash, drain, crisp, and storage system that aids compliance with HACCP guidelines
- Removable dolly allows easy transport
- Assists in complying with FDA Code 3-302, 15 for Washing Fruits and Vegetables



FG263600

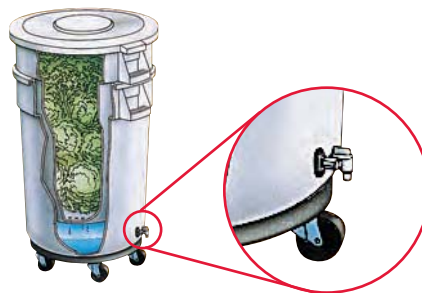

No.	Color	Description	U.S. Capacity	U.S. Dimensions	U.S. Ship Wt/Ctn	Metric Capacity	Metric Dimensions	Metric Ship Wt/Ctn	Lettuce Heads	Case Pack
FG262400	WHT	GreensKeeper® Container, with Lid and Dolly	20 gal	22.5" dia x 33.5" h	21 lbs	75.7 L	57.2 cm dia x 85.1 cm	12.9 kg	27-30	1
FG263600	WHT	GreensKeeper® Container, with Lid and Dolly	32 gal	25" dia x 38.5" h	29.1 lbs	121.1 L	63.5 cm dia x 97.8 cm	13.3 kg	49-52	1

Cake Keeper

Tight-fitting lid helps keep stored food fresh.

- See-through lid provides quick identification of contents
- Base has molded-in center rings; can be used as a serving tray when lid is removed
- Commercial dishwasher-safe
- Stackable



1777191

No.	Color	Description	U.S. Capacity	U.S. Dimensions	U.S. Ship Wt/Ctn	Metric Capacity	Metric Dimensions	Metric Ship Wt/Ctn	Case Pack
1777191	WHT	Cake Keeper	10" Cake/Pie	12.7" l x 13.3" w x 6.8" h	3.4 lbs	25.4 cm	33.5 cm x 32.3 cm x 17.5 cm	1.52 kg	2

BRUTE® "ICE ONLY" Container

Make ice safety a priority!

- Ensures safe ice handling and complies with HACCP guidelines
- No cracking, rusting, or chipping that could potentially contaminate ice
- Compliant with FDA Food Code 3-302.12 for Food Storage Containers with identifiably Common Food Name
- Handles and double-ribbed base allow easy lifting and dragging
- NSF-certified BRUTE® "ICE ONLY" container is durable and easy to clean



FG9F8600



No.	Color	Description	U.S. Capacity	U.S. Dimensions	U.S. Ship Wt/Ctn	Metric Capacity	Metric Dimensions	Metric Ship Wt/Ctn	Case Pack
FG9F8600	WHT	"ICE ONLY" Container	10 gal	15.63" dia x 15.63" l x 17.13" h	19 lbs	37.85 cm	39.7 cm dia x 39.7 cm x 43.5 cm	8.6 kg	6

Food preparation requires frequent hand washing. See the WASHROOMSolutions section for Skin Care Systems premium foam and liquid soaps in a wide choice of formulations, including hypoallergenic antibacterial (NSF E2).

FG750411



FG750112



**Innovative design. Reliable measurement.
Durable construction.**



Rubbermaid Commercial Products is the first to bring digital scale models to the market with a dishwasher-safe outer shell to promote food safety in your commercial kitchen.

With the Full-Size Premium Scales—available in stainless steel or antimicrobial resin—your kitchen will be more efficient, more productive, and safer in your food preparation practices.



Premium Digital Portion Control Scales

Save money on high cost foods with digital portioning.

- Dishwasher-safe removable platform and outer housing
- Reads in pounds by fractional and decimal ounces and grams
- Temperature-compensated load cell for use in refrigerated prep rooms
- Sealed inner chassis resists airborne contamination, slides out for easy cleaning
- Antimicrobial outer shell (resin models only)
- Available in 12-lb (stainless steel and resin) and 6-lb (resin only) capacities, with 200% overload protection
- Includes AC adapter; 50-hour rechargeable battery (included)
- Also may be used with AA batteries (not included)

New!

Dishwasher Safe



1812593



1812595



No.	Description	Increments	U.S. Capacity	U.S. Ship Wt/Ctn	Metric Capacity	Metric Ship Wt/Ctn	Case Pack
1812595	Premium Stainless Steel Dishwasher-Safe Digital Portion Control Scale (12 lb)	0.005 lb, 0.1 oz, 1/4 oz, 1 g	12 lbs	25.0 lbs	6000 g	11.3 kg	4
1812593	Premium Stainless Steel Dishwasher-Safe Digital Portion Control Scale (6 lb)	0.005 lb, 0.05 oz, 1/8 oz, 1 g	6 lbs	16.9 lbs	3000 g	7.7 kg	4
1812594	Premium Stainless Steel Dishwasher-Safe Digital Portion Control Scale (12 lb)	0.005 lb, 0.1 oz, 1/4 oz, 1 g	12 lbs	16.9 lbs	6000 g	7.7 kg	4
1812624	Stainless Steel Replacement Platform for Premium Scales	N/A	N/A	1.0 lbs	N/A	0.5 kg	1

Pizza Scale Kit for Premium Digital Scales

Built for the demands of commercial kitchens.

- Oversized (11.1" x 7.6") platform makes portion control easy
- Remote display for counter or wall mount allows easy viewing
- Remote tare switch for hands-free operation

New!



1812625 (shown with 1812594 scale, not included)



No.	Description	Increments	U.S. Capacity	U.S. Ship Wt/Ctn	Metric Capacity	Metric Ship Wt/Ctn	Case Pack
1812625*	Pizza Scale Kit – oversize platform, display, tare switch	N/A	N/A	11.4 lbs	N/A	5.2 kg	4

* Scale not included

High-Performance Digital Portion Control Scales

Save money on high-cost foods with digital portioning.

- Reads in pounds by fractional and decimal ounces and grams
- Temperature-compensated load cell for use in refrigerated prep rooms
- Antimicrobial protection on resin surfaces
- Available in 2-, 12-, and 24-lb capacities, with 200% overload protection
- Includes AC adapter
- Uses AA batteries (not included)

New!



1812591



No.	Description	Increments	U.S. Capacity	U.S. Ship Wt/Ctn	Metric Capacity	Metric Ship Wt/Ctn	Case Pack
1812590	High-Performance Digital Portion Control Scale (2 lb)	0.005 lb, 0.1 oz, 1/4 oz, 1 g	12 lbs	25.0 lbs	6000 g	11.3 kg	4
1812591	High-Performance Digital Portion Control Scale (12 lb)	0.005 lb, 0.1 oz, 1/4 oz, 1 g	6 lbs	16.9 lbs	3000 g	7.7 kg	4
1812592	High-Performance Digital Portion Control Scale (24 lb)	0.01 lb, 0.2 oz, 1/2 oz, 10 g	12 lbs	16.9 lbs	6000 g	7.7 kg	4
1812617	Stainless Steel Replacement Platform for High-Performance Scales	N/A	N/A	0.5 lbs	N/A	.25 kg	1

Compact Digital Portion Control Scales

New!

Save money on high cost foods with digital portioning.

- Reads in pounds by fractional and decimal ounces and grams
- Temperature-compensated load cell for use in refrigerated prep rooms
- Antimicrobial protection on resin surfaces
- Available in 2- and 10-lb capacities, with 200% overload protection
- Includes AC adapter
- Uses AAA batteries (not included)



1812589

No.	Description	Increments	U.S. Capacity	U.S. Ship Wt/Ctn	Metric Capacity	Metric Ship Wt/Ctn	Case Pack
1812588	Compact Digital Portion Control Scale (2 lb)	0.1 oz, 1/8 oz, 1 g	2 lbs	5.8 lbs	1000 g	2.6 kg	4
1812589	Compact Digital Portion Control Scale (10 lb)	0.1 oz, 1/8 oz, 1 g	10 lbs	5.8 lbs	5000 g	2.6 kg	4
1812616	Stainless Steel Replacement Platform for Compact Scales	N/A	N/A	0.5 lbs	N/A	.25 kg	1

Accessories for Digital Scales

New!

No.	Description	Increments	U.S. Capacity	U.S. Ship Wt/Ctn	Metric Capacity	Metric Ship Wt/Ctn	Case Pack
1812621	Foot/Hip Tare Switch	N/A	N/A	0.8 lbs	N/A	0.4 kg	1
1812623	AC Adapter	N/A	N/A	0.5 lbs	N/A	0.25 kg	1
1812622	Oversized Portion Platform – Stainless Steel	N/A	N/A	2.5 lbs	N/A	1.1 kg	1

Baker's Beam Scales

- Seamless one-piece stainless steel scoop (included)
- Precision weights included for maximum accuracy
- Chrome-plated steel platform
- Adjustable stainless steel counterweight (included) for precise tare of scoop



FGBD16SC

No.	Description	Increments	U.S. Capacity	U.S. Ship Wt/Ctn	Metric Capacity	Metric Ship Wt/Ctn	Case Pack
FGBD16SC	Baker's Beam Scale	1/8 oz	16 lbs	39 lbs	7250 g	17.7 kg	1
FGBD8SC	Baker's Beam Scale	1/8 oz	8 lbs	31 lbs	3600 g	14.1 kg	1
FGBW1	1-lb weight for Baker's Scale	1 lb	1 lb	2 lbs	500 g	.9 kg	1
FGBW2	2-lb weight for Baker's Scale	2 lbs	2 lbs	3 lbs	1000 g	1.4 kg	1
FGBW4	4-lb weight for Baker's Scale	4 lbs	4 lbs	5 lbs	2000 g	2.3 kg	1
FGBC1	Adjustable Counterweight (for use with FGB168S)	N/A	N/A	3 lbs	N/A	1.4 kg	1
FGB168S	Baker's Scale Stainless Steel Scoop (20-lb capacity)	N/A	20 lbs	6 lbs	9000 g	2.7 kg	1

Portion Control Scales, Mechanical

All Premium Mechanical Scales

- Platform serves as a handle
- Precise calibration at factory eliminates need for field recalibration
- Color-coded lens identifies scale capacity "at a glance"
- Removable platform for easy cleaning and HACCP

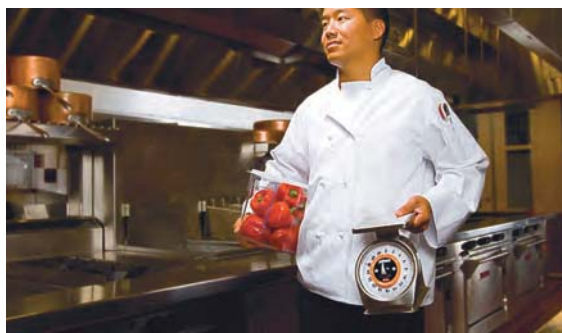

100% Stainless Steel Scales, Dishwasher-Safe

- QuickStop feature stops needle quickly on weight
- 100% dishwasher-safe, no tools required to disassemble
- 30° angled, easy-to-read, shatter-resistant lens
- Rotating dial for multiple ingredient weighing



FG632SRWQ

FG832SRWQ

100% STAINLESS STEEL SCALES WITH QUICKSTOP, DISHWASHER-SAFE

No.	Description	Color Code	U.S. Capacity	Increments	Platform Size	Rotating Dial	U.S. Ship Wt/Ctn	Over/Under Dial	Metric Ship Wt/Ctn	Case Pack
FG832SRWQ	Dishwasher-Safe Mechanical Portion Control Scale w/ QuickStop	Orange	32 oz	1/8 oz	9" x 9"	Yes	42 lbs	Yes	19.1 kg	4
FG632SRWQ	Dishwasher-Safe Mechanical Portion Control Scale w/ QuickStop	Orange	32 oz	1/4 oz	6" x 5.25"	Yes	30 lbs	N/A	13.6 kg	6
FG805SRWQ	Dishwasher-Safe Mechanical Portion Control Scale w/ QuickStop	Green	5 lbs	1/2 oz	9" x 9"	Yes	42 lbs	N/A	19.1 kg	4
FG605SRWQ	Dishwasher-Safe Mechanical Portion Control Scale w/ QuickStop	Green	5 lbs	1/2 oz	6" x 5.25"	Yes	30 lbs	N/A	13.6 kg	6

100% STAINLESS STEEL SCALES, DISHWASHER-SAFE

No.	Description	Color Code	U.S. Capacity	Increments	Platform Size	Rotating Dial	U.S. Ship Wt/Ctn	Over/Under Dial	Metric Ship Wt/Ctn	Case Pack
FG832SRW	Dishwasher-Safe Mechanical Portion Control Scale	Orange	32 oz	1/8 oz	9" x 9"	Yes	42 lbs	Yes	19.1 kg	4
FG632SRW	Dishwasher-Safe Mechanical Portion Control Scale	Orange	32 oz	1/4 oz	6" x 5.25"	Yes	30 lbs	N/A	13.6 kg	6
FG605SRW	Dishwasher-Safe Mechanical Portion Control Scale	Green	5 lbs	1/2 oz	6" x 5.25"	Yes	30 lbs	N/A	13.6 kg	6
FG820SW	Dishwasher-Safe Mechanical Portion Control Scale	Blue	20 lbs	1 oz	9" x 9"	No	42 lbs	N/A	19.1 kg	4
FG625SRW	Dishwasher-Safe Mechanical Portion Control Scale	Blue	25 lbs	2 oz	6" x 5.25"	Yes	30 lbs	N/A	13.6 kg	6
FG840SW	Dishwasher-Safe Mechanical Portion Control Scale	Red	40 lbs	2 oz	9" x 9"	No	42 lbs	N/A	19.1 kg	4

Scales, Washable

- QuickStop feature stops needle quickly on weight
- Durable steel with baked enamel finish for economical option
- Washable, no tools required to disassemble
- 30° angled, easy-to-read, shatter-resistant lens
- Rotating dial (see applicable products below) for multiple ingredient weighing



FG805W

FG832RWQ

SCALES WITH QUICKSTOP, WASHABLE

No.	Description	Color Code	U.S. Capacity	Increments	Platform Size	Rotating Dial	U.S. Ship Wt/Ctn	Over/Under Dial	Metric Ship Wt/Ctn	Case Pack
FG832RWQ	Washable Mechanical Portion Control Scale w/ QuickStop	Orange	32 oz	1/8 oz	9" x 9"	Yes	42 lbs	Yes	19.1 kg	4
FG832WQ	Washable Mechanical Portion Control Scale w/ QuickStop	Orange	32 oz	1/8 oz	9" x 9"	No	42 lbs	N/A	19.1 kg	4
FG805RWQ	Washable Mechanical Portion Control Scale w/ QuickStop	Green	5 lbs	1/2 oz	9" x 9"	Yes	42 lbs	N/A	19.1 kg	4

SCALES, WASHABLE

No.	Description	Color Code	U.S. Capacity	Increments	Platform Size	Rotating Dial	U.S. Ship Wt/Ctn	Over/Under Dial	Metric Ship Wt/Ctn	Case Pack
FG832RW	Washable Mechanical Portion Control Scale	Orange	32 oz	1/8 oz	9" x 9"	Yes	42 lbs	Yes	19.1 kg	4
FG832W	Washable Mechanical Portion Control Scale	Orange	32 oz	1/8 oz	9" x 9"	No	42 lbs	N/A	19.1 kg	4
FG805W	Washable Mechanical Portion Control Scale	Green	5 lbs	1/2 oz	9" x 9"	No	42 lbs	N/A	19.1 kg	4
FG810W	Washable Mechanical Portion Control Scale	Yellow	10 lbs	1 oz	9" x 9"	No	42 lbs	N/A	19.1 kg	4
FG820W	Washable Mechanical Portion Control Scale	Blue	20 lbs	1 oz	9" x 9"	No	42 lbs	N/A	19.1 kg	4
FG840W	Washable Mechanical Portion Control Scale	Red	40 lbs	2 oz	9" x 9"	No	42 lbs	N/A	19.1 kg	4

DUAL-READ WITH U.S. AND METRIC DIAL SCALES, WASHABLE

No.	Description	Color Code	U.S. Capacity	Increments	Platform Size	Rotating Dial	U.S. Ship Wt/Ctn	Metric Capacity	Metric Ship Wt/Ctn	Case Pack
FG832BW	Washable Mechanical Portion Control Scale	Orange	32 oz	1/8 oz, 2 g	9" x 9"	No	42 lbs	900 g	19.1 kg	4
FG810BW	Washable Mechanical Portion Control Scale	Yellow	10 lbs	1 oz, 25 g	9" x 9"	No	42 lbs	4.5 kg	19.1 kg	4
FG820BW	Washable Mechanical Portion Control Scale	Blue	20 lbs	1 oz, 25 g	9" x 9"	No	42 lbs	9 kg	19.1 kg	4
FG840BW	Washable Mechanical Portion Control Scale	Red	40 lbs	2 oz, 50 g	9" x 9"	No	42 lbs	18 kg	19.1 kg	4

WHEN ORDERING PRODUCTS WITH BOLD COLOR CODES, PLEASE SPECIFY COLOR CODE AFTER THE PRODUCT NUMBER. REFER TO THE PRODUCT COLOR GUIDE AT THE BACK OF THE CATALOG.

Y-Line Mechanical Portion Control Scales

- Stainless steel platform and stanchion serve as built-in handle
- Extra-thick anodized aluminum chassis for durability
- Color-coded lens identifies scale capacity "at a glance"



FGY32R



FGYG400R



ROTATING DIAL

No.	Description	Color Code	U.S. Capacity	Increments	U.S. Ship Wt/Ctn	Platform Size	Metric Ship Wt/Ctn	Case Pack
FGY16R	Mechanical Portion Control Scale	●	16 oz	¼ oz	23 lbs	4.5" x 5.75"	10.4 kg	6
FGY32R	Mechanical Portion Control Scale	●	32 oz	¼ oz	23 lbs	4.5" x 5.75"	10.4 kg	6
FGYG180R	Mechanical Portion Control Scale	●	5 lbs	½ oz	23 lbs	4.5" x 5.75"	10.4 kg	6
FGYG425R	Mechanical Portion Control Scale	●	25 lbs	2 oz	23 lbs	4.5" x 5.75"	10.4 kg	6
FGYG450R	Mechanical Portion Control Scale	●	50 lbs	4 oz	23 lbs	4.5" x 5.75"	10.4 kg	6

FIXED DIAL

No.	Description	Color Code	U.S. Capacity	Increments	U.S. Ship Wt/Ctn	Platform Size	Metric Ship Wt/Ctn	Case Pack
FGY200R	Mechanical Portion Control Scale	●	32 oz	¼ oz	23 lbs	4.5" x 5.75"	10.4 kg	6
FGYG400R	Mechanical Portion Control Scale	●	25 lbs	2 oz	23 lbs	4.5" x 5.75"	10.4 kg	6
FGYG800R	Mechanical Portion Control Scale	●	50 lbs	4 oz	23 lbs	4.5" x 5.75"	10.4 kg	6
FGY50	Mechanical Portion Control Scale	●	50 lbs	2 oz	23 lbs	4.5" x 5.75"	10.4 kg	6

DUAL-READ AND METRIC DIAL SCALES

No.	Description	Color Code	U.S. Capacity	Increments	U.S. Ship Wt/Ctn	Metric Capacity	Metric Ship Wt/Ctn	Case Pack
FGYG1000R	Mechanical Portion Control Scale – Metric		N/A	5 g	23 lbs	1000 g	10.4 kg	6
FGYG500R	Mechanical Portion Control Scale – Metric		N/A	20 g	23 lbs	5000 g	10.4 kg	6
FGA12R	Mechanical Portion Control Scale – Dual Read	●	32 oz	¼ oz, 5 g	23 lbs	900 g	10.4 kg	6
FGA22R	Mechanical Portion Control Scale – Dual Read	●	5 lbs	½ oz, 10 g	23 lbs	2 kg	10.4 kg	6
FGA012R	Mechanical Portion Control Scale – Dual Read	●	25 lbs	2 oz, 50 g	23 lbs	10 kg	10.4 kg	6

Compact Portion Control Scales

- Compact, space-saving size
- Stainless steel platform for sanitary contact surface
- Durable ABS plastic chassis
- Fixed dial with zero-adjust knob



FGK16SS



FGK32CUP



FGKF16SS



No.	Description	U.S. Capacity	Increments	U.S. Ship Wt/Ctn	Platform Size	Metric Ship Wt/Ctn	Case Pack
FGK32	Oven-Run Scale with 1 pt Measuring Cup	32 oz	¼ oz	10 lbs	3.75" x 4.25"	4.5 kg	6
FGK32CUP	Measuring Cup for FGK32 (1 pt/16 oz/2 cup)	16 oz	N/A	N/A	3.75" x 4.25"	N/A	1
FGK16SS	Compact Portion Control Scale	16 oz	¼ oz	8 lbs	3.75" x 4.25"	3.6 kg	6
FGKF16SS	Compact Portion Control Scale with Contoured Platform	16 oz	¼ oz	10 lbs	N/A	4.5 kg	6

Hanging Scales

- Tare feature removes weight of container
- Heavy-duty steel hooks will not break or bend
- Optional hanging adapter for use on doors and beams
- Digital scales feature memory setting for up to 4 weighs



FG0077500000



FG0078420000



FG0078950000



FG0079080000



DIGITAL HANGING SCALES

No.	Description	U.S. Capacity	Increments	U.S. Ship Wt/Ctn	Metric Capacity	Metric Ship Wt/Ctn	Case Pack
FG00775000000	Digital Hanging Scale	50 lbs	1 oz, 20 g	6 lbs	22.5 kg	2.72 kg	4
FG00771000000	Digital Hanging Scale	100 lbs	2 oz, 50 g	6 lbs	45 kg	2.72 kg	4

MECHANICAL HANGING SCALES

No.	Description	U.S. Capacity	Increments	U.S. Ship Wt/Ctn	Metric Capacity	Metric Ship Wt/Ctn	Case Pack
FG007842000000	Dial Hanging Scale with Tare	20 lbs	1 oz, 25 g	13 lbs	9 kg	5.9 kg	4
FG007826000000	Hanging Scale	26 lbs	1 lb, 250 g	4 lbs	12 kg	1.8 kg	12
FG007895000000	Compact Hanging Scale	50 lbs	1 lb, 0.5 kg	6 lbs	22.5 kg	2.7 kg	4
FG007800000000	Dial Hanging Scale	70 lbs	½ lb, 50 g	14 lbs	31 kg	6.4 kg	4
FG007810000000	Hanging Scale	110 lbs	1 lb, 0.5 kg	18 lbs	50 kg	8.2 kg	4
FG007820000000	Hanging Scale	220 lbs	2 lbs, 1 kg	21 lbs	100 kg	9.5 kg	4
FG007830000000	Hanging Scale	330 lbs	5 lbs, 2 kg	22 lbs	150 kg	10 kg	4
FG007908000000	Galvanized Steel Scoop	N/A	N/A	7 lbs	N/A	3.2 kg	1

Digital Receiving/Utility Scales

Proper inventory control begins at the receiving door.



FG401088 / FG404088

4010/4040 DIGITAL RECEIVING SCALES

- Rugged 18-gauge scale designed to handle heavy packages and containers
- Remote 1/2" LCD wall-mount display saves counter space and provides eye-level readout (9' cord reach) for employee-safe receiving
- Tare feature removes weight of container
- Low-profile, nonskid platform allows for easy weighing

No.	Description	Increments	U.S. Capacity	U.S. Ship Wt/Ctn	Metric Capacity	Metric Ship Wt/Ctn	Case Pack
FG401088	Digital Receiving Scale	0.2 lb, 0.1 kg	150 lbs	22 lbs	68 kg	10 kg	2
FG404088	Digital Receiving Scale	0.5 lb, 0.2 kg	400 lbs	22 lbs	180 kg	10 kg	2

Briefcase/Utility Mechanical Receiving Scales

Low-profile receiving scale for foodservice, industrial, or office environments.



FGP250S

- Multiribbed platform is sturdy enough for bulky crates or heavy cartons
- Memory Lock™ feature locks in weight when dial is secure
- Low platform design allows for cartons to easily slide onto scale, improving employee safety
- Protected zero-adjust knob for precise zero reset
- Nonskid feet ensure weighing stability

No.	Description	Increments	U.S. Capacity	U.S. Ship Wt/Ctn	Metric Capacity	Metric Ship Wt/Ctn	Case Pack
FGP100S	Briefcase Receiving Scale	1 lb	100 lbs	20 lbs	N/A	9.1 kg	2
FGP114S	Briefcase Receiving Scale – Metric	0.5 kg	N/A	20 lbs	114 kg	9.1 kg	2
FGP250S	Briefcase Receiving Scale	1 lb	250 lbs	20 lbs	N/A	9.1 kg	2
FGP250SS	Briefcase Receiving Scale	1 lb	250 lbs	20 lbs	N/A	9.1 kg	2

Platform Receiving Scales

Heavy-duty platform scale for tabletop weighing

- Temperature-compensated for use in refrigerated prep rooms and throughout the flow of food
- 30° angled, easy-to-read, shatter-resistant lens
- Heavy-duty steel construction
- Zero-adjust knob for precise zero reset



FG10100S

PLATFORM RECEIVING SCALES: STAINLESS STEEL WITH FIXED DIAL

No.	Description	Increments	U.S. Capacity	U.S. Ship Wt/Ctn	Metric Capacity	Metric Ship Wt/Ctn	Case Pack
FG10100S	Heavy-Duty Receiving Scale	4 oz	100 lbs	52 lbs	N/A	23.6 kg	2
FG10200S	Heavy-Duty Receiving Scale	8 oz	200 lbs	59 lbs	N/A	26.8 kg	2

PLATFORM RECEIVING SCALES: STEEL WITH BAKED-ENAMEL FINISH AND FIXED DIAL

No.	Description	Increments	U.S. Capacity	U.S. Ship Wt/Ctn	Metric Capacity	Metric Ship Wt/Ctn	Case Pack
FG10100	Heavy-Duty Receiving Scale	4 oz	100 lbs	52 lbs	N/A	23.6 kg	2
FG10200	Heavy-Duty Receiving Scale	8 oz	200 lbs	59 lbs	N/A	26.8 kg	2
FG1060	Heavy-Duty Receiving Scale	4 oz	60 lbs	52 lbs	N/A	23.6 kg	2
FG10B60	Heavy-Duty Receiving Scale – Dual-Read	4 oz, 100 g	60 lbs	52 lbs	27 kg	23.6 kg	2
FG10B100	Heavy-Duty Receiving Scale – Dual-Read	4 oz, 100 g	100 lbs	52 lbs	45 kg	23.6 kg	2
FG10B200	Heavy-Duty Receiving Scale – Dual-Read	8 oz, 250 g	200 lbs	59 lbs	90 kg	26.8 kg	2

TEMPERATURE MONITORING IS A CRITICAL PRACTICE TO ENSURE PROPER FOOD SAFETY

Thermocouples are widely used in the foodservice industry for their ability to provide quick and precise temperature measurements. Thermocouples have built-in microprocessors that provide reads within 1/10th of a degree. Everyone from health inspectors to chefs uses thermocouples due to their ability to measure a wide range of temperatures quickly and accurately to ensure proper food safety.



Thermocouples provide fast and accurate temperature solutions for any foodservice operation.

Thermocouples

Essential tool for any HACCP plan.

FGTMP2000

- Min/Max/Hold modes
- Microtip probe included with built-in storage and protection
- Dual-read Fahrenheit and Celsius
- IP54 rating for dust and moisture
- Auto-off, low battery functions
- 9V battery and custom travel pouch included
- NSF-approved

TYPE K THERMOCOUPLE PROBES

Temperature monitoring evolved.

- Manufactured and tested 4x greater than standard ANSI specifications
- Quick 7–8 second temperature reading
- Interchanges with FGTMP2000



FGTMP2000



FGTHOP

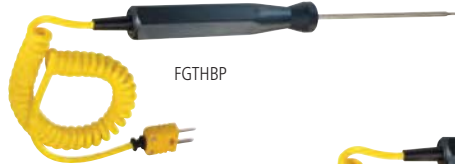

FGTHBP



FGTHMP

No.	Description	Temperature Range	Degree Increments	Stem Length	U.S. Ship Wt/Ctn	Metric Ship Wt/Ctn	Case Pack
FGTMP2000	Thermocouple	-50°–450°F (-40°–230°C)	0.1°F, 0.1°C	4¾"	3.5 lbs	1.6 kg	4
FGTHOP	Type K Thermocouple – Oven Probe	-58°–482°F (-50°–250°C)	0°–100°C, ± 5°C	2"	12.8 lbs	5.8 kg	50
FGTHBP	Type K Thermocouple – Burger Probe	-58°–482°F (-50°–250°C)	0°–100°C, ± 5°C	¼" (8½" probe)	12.8 lbs	5.8 kg	50
FGTHMP	Type K Thermocouple – Microtip Probe	-58°–482°F (-50°–250°C)	0°–100°C, ± 5°C	4½"	12.8 lbs	5.8 kg	50

Infrared Thermometer

Fast, reliable surface temperature measurement.

- 6:1 ratio
- Ergonomic, palm-sized design with trigger button on side
- Min/Max modes
- Dual-read Fahrenheit and Celsius



FGTMP500

No.	Description	Temperature Range	Degree Increments	Stem Length	U.S. Ship Wt/Ctn	Metric Ship Wt/Ctn	Case Pack
FGTMP500	Pocket Infrared Thermometer	-67°–482°F (-55°–250°C)	0.1°F, 0.1°C	6:1 IR Ratio	2.6 lbs	1.6 kg	12

Digital Thermometers

The first defense against food-borne illness.



FGTMP1000

- Monitoring and ware washing machine temperatures
- Easy user calibration
- Min/Max/Hold modes
- Dual-read Fahrenheit and Celsius
- NSF-approved

FGTHP302L

- Large ¾" LCD display
- Dual-read Fahrenheit and Celsius
- Hold button
- NSF-approved



FGTHP302L



FGTMP1000

No.	Description	Temperature Range	Degree Increments	Stem Length	U.S. Ship Wt/Ctn	Metric Ship Wt/Ctn	Case Pack
FGTHP302L	Digital Pocket	-58°–302°F	1°F	47/8"	2 lbs	0.9 kg	12
FGTMP1000	Digital Pocket	-40°–450°F (-58°–230°C)	0.1°F, 0.1°C	5"	2.1 lbs	1 kg	12

Dial Pocket Thermometer

- Dishwasher-safe design
- Built-in sheath calibration tool
- Shatter-resistant lens
- Stainless steel construction



FGTHP220DS



FGTHP550DS

No.	Description	Temperature Range	Degree Increments	Stem Length	U.S. Ship Wt/Ctn	Metric Ship Wt/Ctn	Case Pack
FGTHP160DS	Dishwasher-Safe Pocket Thermometer	-40°–160°F	2°F	5"	0.9 lbs	0.4 kg	12
FGTHP220C	Pocket Thermometer	0°–220°F	2°F	5"	0.9 lbs	0.4 kg	12
FGTHP220DS	Dishwasher-Safe Pocket Thermometer	0°–220°F	2°F	5"	0.9 lbs	0.4 kg	12
FGTHP550DS	Dishwasher-Safe Pocket Thermometer	50°–550°F	5°F	5"	0.9 lbs	0.4 kg	12

WHEN ORDERING PRODUCTS WITH BOLD COLOR CODES, PLEASE SPECIFY COLOR CODE AFTER THE PRODUCT NUMBER. REFER TO THE PRODUCT COLOR GUIDE AT THE BACK OF THE CATALOG.

Equipment-Monitoring Thermometer

Keep food safe by properly monitoring equipment.

- Hangs or stands for easy installation
- HACCP safe zones
- Large easy-to-read dial
- Stainless steel
- NSF-approved



No.	Description	Temperature Range	Degree Increments	U.S. Ship Wt/Ctn	Metric Ship Wt/Ctn	Case Pack
FGTHR80P	Refrigerator/Freezer (non-carded)	-20°-120°F (-30°-50°C)	2°F, 1°C	0.8 lbs	0.3 kg	12
FGTHR80C	Refrigerator/Freezer (carded blister)	-20°-120°F (-30°-50°C)	2°F, 1°C	0.8 lbs	0.3 kg	12
FGTHW180	Warming/Proofing	100°-180°F	2°F	1.6 lbs	0.7 kg	12
FGCOT550C	Oven	60°-580°F (20°-300°C)	10°F, 10°C	3.0 lbs	1.4 kg	12
FGR80DC	Refrigerator/Freezer	-20°-80°F (-30°-30°C)	2°F, 1°C	1.6 lbs	0.7 kg	12
FGR80GC	Refrigerator/Freezer	-40°-80°F (-40°-30°C)	2°F, 1°C	1.3 lbs	0.6 kg	12
FGTHG600	Grill	100°-600°F (50°-300°C)	10°F, 10°C	1.6 lbs	0.7 kg	12
FGTHO550	Oven	60°-590°F (16°-310°C)	10°F, 10°C	1.6 lbs	0.7 kg	12

Food Preparation Thermometer

Improve taste and safety with food preparation thermometers.

- Dishwasher-safe (FGTHB212DS, FGTHM200DS, FGTHC400DS)
- HACCP zones
- Built-in sheath calibration tool
- Dual-read Fahrenheit and Celsius
- Stainless steel



No.	Description	Temperature Range	Degree Increments	Stem Length	U.S. Ship Wt/Ctn	Metric Ship Wt/Ctn	Case Pack
FGTHM200DS	Dishwasher-Safe Meat Thermometer, 2 1/2" Dial	120°-212°F (50°-100°C)	2°F, 1°C	4 3/8"	3.0 lbs	1.4 kg	12
FGTHC400DS	Dishwasher-Safe Candy Thermometer	100°-400°F (30°-220°C)	5°F, 2°C	5 1/2"	3.3 lbs	1.5 kg	12
FGCC400DC	Candy	100°-400°F (30°-220°C)	5°F, 5°C	6"	3.3 lbs	1.5 kg	12
FGCM200C	Meat	0°-200°F	2°F	4 3/8"	4.0 lbs	1.8 kg	12
FGTHB212DSP	Dishwasher-Safe Meat Thermometer, 1 1/2" Dial	120°-212°F (50°-100°C)	2°F, 1°C	4 3/8"	3.0 lbs	1.4 kg	12

Timers

MULTIFUNCTION TIMER

- Four independent timing cycles with loud, distinct alarms for multitasking
- Reverse timer after alarm
- Oil- and water-resistant
- Last entry recall
- One-second increments for up/down count modes



FGDT2488



DIGITAL TIMER

- Start/Stop feature
- Alarm bell
- Fold-out magnetic stand

FGR441188

FGR442188



MECHANICAL TIMER

- Easy to operate
- No batteries required
- Loud alarm bell

MT60F88



No.	Description	Increments	Timing Capacity	U.S. Ship Wt/Ctn	Metric Ship Wt/Ctn	Case Pack
FGDT2488	4-Function Digital Timer	1 second	24 hour	3.4 lbs	1.5 kg	6
FGR441188	Digital Timer	1 minute	20 hour	1.7 lbs	0.8 kg	12
FGR442188	Compact Digital Timer	1 second	24 hour	2 lbs	0.9 kg	12
MT60F88	Mechanical Timer	1 minute	60 minute	2 lbs	0.9 kg	6

ProServe® Ice Handling System

Promotes safe transfer of ice to reduce risk of cross-contamination and improves employee safety.

ProServe® ICE TOTE WITH BIN HOOK ADAPTER

Adapter keeps tote off floor, reducing cross-contamination.

- Bin hook adapter attaches to ice machine for ease of transfer and reduced back strain
- Elevated base hand grip reduces cross-contamination
- Nonnesting and fits in most commercial dishwashers



Ice flow from corners reduces spillage and improves safety.

ProServe® ICE CART FOR FOUR ICE TOTES AND LIDS

Safely transport 100 lbs of ice.

- Ice totes held securely for safe transport
- Handle folds flat for storage
- Lid hook included
- Side rails fold in to accommodate 2 or 4 totes



ProServe® 74-OZ SCOOP WITH HAND GUARD AND HOLDER

15% greater capacity than standard scoop.

- Ice cavity under handle protects ice
- Reinforced leading edge
- Open air holder for reduced mold and bacteria growth
- Commercial dishwasher-safe

ProServe® 120-OZ SCOVEL™ TWO-HANDLED SHOVEL

High sides for ice containment.

- Reinforced leading edge
- Commercial dishwasher-safe

3X

FASTER
filling of ice totes

Improve efficiency by transporting up to 4 totes at the same time (100 lbs of ice).



FG9F5000



FG9F5100



FG9F5200



FG9F5400



FG9F7300



FG9F5500

No.	Color	Description	U.S. Dimensions	U.S. Ship Wt/Ctn	Metric Dimensions	Metric Ship Wt/Ctn	Case Pack
FG9F4300 ¹	0000	Scoop Holder	10.1" l x 7.5" w x 5.4" h	5.83 lbs	25.7 cm x 19.1 cm x 13.7 cm	2.6 kg	6
FG9F5000	TBLUE	74-oz Scoop with Hand Guard	12" l x 6.7" w x 7.7" h	7.1 lbs	30.5 cm x 17 cm x 19.6 cm	3.2 kg	6
FG9F5100 ¹	TBLUE	74-oz Scoop with Hand Guard and Holder	12.1" l x 7.5" w x 8" h	2.25 lbs	30.7 cm x 19.1 cm x 20.3 cm	1 kg	1
FG9F5200	TBLUE	Scovel™ Two-Handled Shovel	29.4" l x 8.8" w x 6.9" h	3.1 lbs	74.7 cm x 22.4 cm x 17.5 cm	1.4 kg	1
FG9F5300	TBLUE	Ice Tote	10.5" l x 13.3" w x 22.1" h	4.3 lbs	26.7 cm x 33.8 cm x 56.1 cm	2 kg	1
FG9F5400	TBLUE	Ice Tote with Bin Hook Adapter	12.2" l x 13.3" w x 22.1" h	4 lbs	31 cm x 33.8 cm x 56.1 cm	1.8 kg	1
FG9F5500	BLA	Ice Cart	21.44" l x 5.69" w x 39.13" h	36.5 lbs	54.5 cm x 14.5 cm x 99.4 cm	16.6 kg	1
FG9F5600	0000	Ice Bin Hook Adapter	9.9" l x 11.8" w x 1.7" h	2.9 lbs	25.1 cm x 30 cm x 4.3 cm	1.3 kg	6
FG9F7300	BLA	Ice Tote Lid	12" l x 11.25" w x 2" h	2.4 lbs	30.5 cm x 28.6 cm x 5.1 cm	1.1 kg	4

¹ Holder is not NSF-listed.

ProServe® Lightweight Insulated Carriers

Four layers of thermal retention provide lightweight option for safely transporting food and beverages.

- Keeps hot food hot and cold food cold safely for 4 hours
- ProServe® carriers are lighter than solid competitive products, decreasing risk of ergonomic stress
- Divider for FG9F1500 allows separation within carrier between hot and cold food storage
- Time temperature monitoring and labeling is easy with large identification window secured to each carrier



FG9F1600



RIGID INTERIOR INSULATION

Lightweight and over 300% stronger than Styrofoam^{®1} polystyrene, Expanded Polypropylene (EPP) resists flaking, cleans easily, and provides uncompromising support.

REFLECTIVE VAPOR BARRIER

Helps maintain even temperature throughout the carrier, so foods maintain their ideal temperatures.

NONWOVEN POLYESTER INSULATION

Nearly an inch thick, it's the same insulation used in high-performance cold-weather gear. Will not retain moisture or odors.

COMMERCIAL-GRADE NYLON EXTERIOR

Strong (840 denier) nylon surrounds and protects the inner layers.



FG9G4000 Divider for FG9F1500 allows separation within carrier between hot and cold food storage and reduces risk of cross-contamination.

HEAT LOSS AND COLD RETENTION

WEIGHT COMPARISON

No.	Heat Loss in °F/Hr* (°C/Hr)	Heat Gain in °F/Hr* (°C/Hr)	ProServe®	Traditional Equivalent [†]	Difference
FG9F1200	5.5 °F (3.1°C)	+0.2 °F (0.1°C)	10.6 lb	24.3 lb	56%
FG9F1300	6.0 °F (3.3°C)	+0.4 °F (0.2°C)	14.9 lb	28.7 lb	48%
FG9F1400	5.7 °F (3.2°C)	+0.3 °F (0.2°C)	17.0 lb	29.5 lb	52%
FG9F1500	5.8 °F (3.2°C)	+0.5 °F (0.3°C)	6.3 lb	26.5 lb	76%
FG9F1600	5.2 °F (2.9°C)	+0.6 °F (0.3°C)	11.1 lb	27.5 lb	60%

*Average calculated on the basis of a 4-hour period

[†]Traditional rigid containers



FG9F1500



FG9F1400



FG9F1300



FG9F1200



FG9F1900

PROSERVE® INSULATED CARRIERS

No.	Color	Description	U.S. Dimensions	U.S. Ship Wt/Ctn	Metric Dimensions	Metric Ship Wt/Ctn	Pan Capacity	Case Pack
FG9F1200	CGRAY	ProServe® Insulated End-Load, Full-Pan Carrier, Small	27" l x 18.25" w x 16" h	13.0 lbs	68.6 cm x 46.4 cm x 40.6 cm	5.90 kg	Three 2½" or two 4" deep pans	1
FG9F1300	CGRAY	ProServe® Insulated End-Load, Full-Pan Carrier, Medium	27" l x 19.5" w x 22.5" h	17.5 lbs	68.6 cm x 49.5 cm x 57.2 cm	7.94 kg	Five 2½" or three 4" deep pans	1
FG9F1400	CGRAY	ProServe® Insulated End-Load, Full-Pan Carrier, Large	27" l x 21.5" w x 29" h	20.1 lbs	68.6 cm x 54.6 cm x 73.7 cm	9.12 kg	Seven 2½" or four 4" deep pans	1
FG9F1500	CGRAY	ProServe® Insulated Top-Load, Half-Pan Carrier	19" l x 16.75" w x 15" h	8.3 lbs	48.3 cm x 42.5 cm x 38.1 cm	3.76 kg	Three 2½" or two 4" deep pans	1
FG9F1600	CGRAY	ProServe® Insulated Top-Load, Full-Pan Carrier	28" l x 19.25" w x 19.5" h	14.0 lbs	71.1 cm x 48.9 cm x 49.5 cm	6.35 kg	Five 2½" or three 4" deep pans	1

PROSERVE® INSULATED CARRIER ACCESSORY

No.	Color	Description	U.S. Dimensions	U.S. Ship Wt/Ctn	Metric Dimensions	Metric Ship Wt/Ctn	Pan Capacity	Case Pack
FG9F1900	BLA	ProServe® Insulated Carrier Dolly with Retention Strap	28.75" l x 22.25" w x 10" h	14.5 lbs	73 cm x 56.5 cm x 25.4 cm	6.58 kg	Holds up to 325 lbs	1

¹ Styrofoam® is a registered trademark of the Dow Chemical Company.

ProServe® Professional Delivery Bags

Reliable professional delivery bags for those on the go!

- Two inches of polyester insulation offers maximum thermal retention with no moisture and odor retention
- Durable, commercial-grade nylon exterior will not deteriorate with use and offers years of performance
- Commercial-grade zippers and hook and loop closures protect food while metal grommets release excess steam to maintain food quality
- Large identification window allows for easy labeling of orders, dates, and temperatures
- Commercial dishwasher-safe, with hanging loop for proper drying



No.	Color	Description	Bag Capacity	U.S. Dimensions	U.S. Ship Wt/Ctn	Metric Dimensions	Metric Ship Wt/Ctn	Case Pack
FG9F3500	RED	ProServe® Pizza Delivery Bag, Small	Two 16" Pizzas	18" l x 18" w x 5.25" h	15 lbs	45.7 cm x 45.7 cm x 13.3 cm	6.8 kg	6
FG9F3600	RED	ProServe® Pizza Delivery Bag, Medium	Four 12" or Three 14" Pizzas	18" l x 17.25" w x 7.75" h	15 lbs	45.7 cm x 43.8 cm x 19.7 cm	6.8 kg	6
FG9F3700	RED	ProServe® Pizza Delivery Bag, Large	Four 16" or Three 18" Pizzas	21.5" l x 19.75" w x 7.75" h	18 lbs	54.6 cm x 50.2 cm x 19.7 cm	8.2 kg	6
FG9F3800	RED	ProServe® Pizza/Catering/Sandwich Delivery Bag, Medium	Six 12" to 14" Pizzas	17" l x 17" w x 13" h	13.5 lbs	43.2 cm x 43.2 cm x 33 cm	6.1 kg	4
FG9F3900	RED	ProServe® Pizza/Catering/Sandwich Delivery Bag, Large	Six 16" Pizzas	19.75" l x 19.75" w x 13" h	15.5 lbs	50.2 cm x 50.2 cm x 33 cm	7.0 kg	4
FG9F4000	RED	ProServe® Sandwich Delivery Bag	Fifteen 12" Sub Sandwiches	15" l x 12" w x 12" h	13.5 lbs	38.1 cm x 30.5 cm x 30.5 cm	6.1 kg	4

CaterMax™ Insulated Carriers

Preserve food quality—and your reputation.

- Serpentine seal maintains safe food temperatures during transport
- NSF-certified for cleanability
- Durable plastic hardware and shell will stand up to the rigors of transport
- Attractive styles and colors allow food to go from storage to transport to serving
- No gaskets or replacement parts needed
- Trolley's three-position handle lets users push, pull, or fold flat for use as a dolly



FOOD SAFE ZONE

CaterMax™ Insulated Carriers retain temperature better than competitor carriers to preserve food freshness and quality.

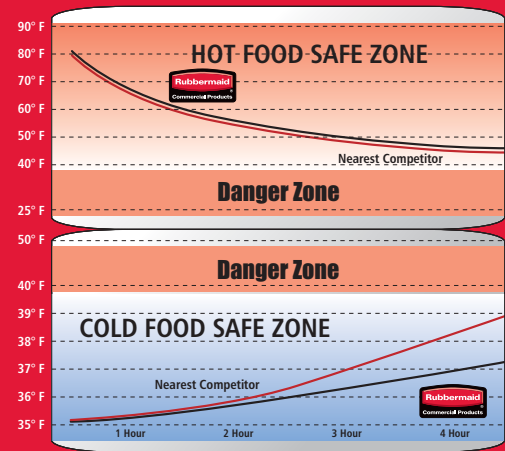

No.	Color	Description	U.S. Capacity	U.S. Dimensions	U.S. Ship Wt/Ctn	Metric Capacity	Metric Dimensions	Metric Ship Wt/Ctn	Case Pack
FG940600	BLA PLAT	CaterMax™ 25 Insulated Single-Pan Carrier accommodates 1/1, 1/2, and 1/3 Food Pans	23 qt	29.5" l x 19" w x 10.63" h	22.1 lbs	21.8 L	74.9 cm x 48.3 cm x 27 cm	10 kg	1
FG940700	BLA PLAT	CaterMax™ 50 Insulated Four-Pan Carrier accommodates 1/1, 1/2, and 1/3 Food Pans	55 qt	29.5" l x 19" w x 15.5" h	27.5 lbs	52 L	74.9 cm x 48.3 cm x 39.4 cm	12.5 kg	1
FG940800	BLA PLAT	CaterMax™ 100 Insulated End-Load Pan Carrier accommodates 1/1, 1/2, and 1/3 Food Pans	94 qt	18.75" l x 26.75" w x 27.75" h	59.35 lbs	89 L	47.6 cm x 67.9 cm x 70.5 cm	26.9 kg	1
FG940888	BLA PLAT	CaterMax™ 100 Insulated End-Load Pan Carrier with 5" (12.7 cm) Swivel Casters accommodates 1/1, 1/2, and 1/3 Food Pans	94 qt	18.75" l x 26.75" w x 33.63" h	64.35 lbs	89 L	47.6 cm x 67.9 cm x 85.4 cm	29.2 kg	1
FG440186	BLA	Caterer's Trolley transports FG940600, FG940700, and FG940800 CaterMax™ Carriers	400 lbs	32.5" l x 20.5" w	24 lbs	181.4 kg	82.6 cm x 52.1 cm	10.9 kg	1

WHEN ORDERING PRODUCTS WITH **BOLD** COLOR CODES, PLEASE SPECIFY COLOR CODE AFTER THE PRODUCT NUMBER. REFER TO THE PRODUCT COLOR GUIDE AT THE BACK OF THE CATALOG.

ProServe® Sheet Pan Rack System

Safely transport food from oven to freezer.

- Encourage employee safety with user-friendly handles and protective bumpers
- PanGuard™ Locking Bar secures pan, and extend base enhances stability to eliminate costly spills
- Easy-to-clean industrial-grade plastic top and bottom and chrome-plated side panels resist rust and corrosion
- Holds 18" x 26" sheet pans at the base, not the edges, for added support
- Heavy-duty thread guard, 5" dia. x 1/4" wide (12.7 cm), features two locking casters
- Vinyl Rack Cover (FG9F9000) reduces cross-contamination when used with ProServe® Rack System NSF-certified



FG9F9700



FG9F9000

No.	Color	Description	Pan Capacity	U.S. Dimensions	U.S. Weight Capacity	U.S. Ship Wt/Ctn	Metric Dimensions	Metric Weight Capacity	Metric Ship Wt/Ctn	Case Pack
FG9F9700	BLA	ProServe® Standard Base Sheet Pan Rack	26 Slots w/ 2" (5.08 cm) spacing	23" l x 28" w x 69.63" h	300 lbs	80 lbs	58.4 cm x 71.1 cm x 178.8 cm	136.1 kg	36.3 kg	1
FG9F9000	CLR	Vinyl Rack Cover for FG9F9700, FG332000 Racks		23.5" l x 29.5" w x 70.5" h		5.5 lbs	59.7 cm x 74.9 cm x 179.1 cm		2.5 kg	1

ProServe® Racks and Carts

Increase efficiency by maximizing space, transportation, and storage.

- Versatile system specially designed to work with food pans, food boxes, and sheet pans
- Impact-resistant structural web plastic components stand up to the most demanding kitchens
- Racks and carts are designed with soft, round corners that are easy on the walls, doors, and equipment
- Stylish design and quiet handling moves food easily from kitchen to dining room, minimizing expensive labor costs
- USDA Meat and Poultry Group listed
- NSF-certified for cleanability
- Casters are 5" (12.7 cm) nonmarking, swivel-plate design (two are lockable)



Convenient disposal hole helps keep worksurface clear of debris

FG331600



FG331600

FG332000

FG331500

FG331700

FG332400

FG331500 / FG331700

Prep Cart-End Loader

Opening: 13" (33 cm)

Accommodates:



FG331600

Prep Cart-Side Loader

Opening: 26 1/8" (66.4 cm)

Accommodates:

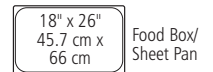

FG332000

Rack-End Loader

Opening: 19 1/16" (50.32 cm)

Accommodates:

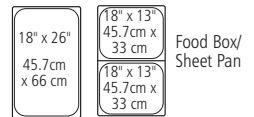

FG332400

Rack-Dual End Loader

Opening: 21 1/16" (53.5 cm)

Accommodates:



No.	Color	Description	Pan Capacity	U.S. Dimensions	U.S. Ship Wt/Ctn	Metric Dimensions	Metric Ship Wt/Ctn	Case Pack
FG331500 ^a	OWHT BLA	ProServe® Prep Cart with Cutting Board (8-slot end loader for full-size insert pans)	8	23.75" l x 18.63" w x 36.13" h	44.8 lbs	60.3 cm x 47.3 cm x 91.8 cm	20.3 kg	1
FG331600 ^a	OWHT BLA	ProServe® Prep Cart with Cutting Board (8-slot side loader for food boxes and sheet pans)	8	31.75" l x 23.75" w x 36.13" h	52 lbs	80.6 cm x 60.3 cm x 91.8 cm	23.6 kg	1
FG331700	OWHT BLA	ProServe® Rack (18-slot end loader for full-size insert pans)	18	23.75" l x 18.63" w x 67.88" h	68.4 lbs	60.3 cm x 47.3 cm x 172.4 cm	31 kg	1
FG331900	OWHT	ProServe® Rack (18-slot side loader for food boxes and sheet pans)	18	31.75" l x 23.75" w x 67.88" h	72.3 lbs	80.6 cm x 60.3 cm x 172.4 cm	32.8 kg	1
FG332000	OWHT BLA	ProServe® Rack (18-slot end loader for food boxes and sheet pans)	18	28.75" l x 23.75" w x 67.88" h	82 lbs	73 cm x 60.3 cm x 172.4 cm	37.2 kg	1
FG332400	OWHT BLA	ProServe® Rack (18-slot dual loader for full-size insert pans)	18	26.7" l x 28.75" w x 67.88" h	82 lbs	67.8 cm x 73 cm x 172.4 cm	37.2 kg	1

^aIncludes NSF Food Zone-approved Max System™ Cutting Board

Convertible Utility Cart **New!**

Ideal for catering—converts from a utility cart to a platform truck in just seconds.

- Innovative design
- Multifunctional productivity with improved worker well-being—saving you time and money



PUSH BUTTONS

Depress buttons to easily convert from utility cart to platform truck.



LOCKING CASTERS

Rear wheel locks keep cart safely in place while loading and unloading.



FOOT PEDAL

Depress foot pedal to fold cart for storage.



Product Innovation Award Winner
2007 ISSA/InterClean® North American Convention

ERGONOMIC HANDLE
Designed for comfort.

RECESSED TOP
Helps retain items on shelf during transport.

CART ACCESSORIES
see "Cart Accessories"

NARROW PROFILE
Easily navigate through doorways and hallways.



EXTENDED DECK
Makes loading the lower shelf easier.

CASTERS WITH LOCKS
Four 5" nonmarking casters (2 fixed, 2 swivel) help cart move easily, even through tight spaces.

QUICK CONVERSION

Easily converts from a utility cart to a platform truck, and then folds flat for storage.

FOLDS FROM 34 3/8" TO 10 7/8" FOR EASY STORAGE



UTILITY CART

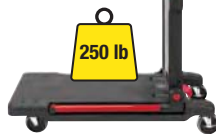

PLATFORM TRUCK



34 3/8" High

10 7/8" High

No.	Color	Description	U.S. Dimensions	U.S. Capacity	U.S. Ship Wt/Ctn	Metric Dimensions	Metric Capacity	Metric Ship Wt/Ctn	Pack
FG430000	BLA	Convertible Utility Cart	45.2" l x 23.8" w x 34.4" h	400 lb	52.0 lb	115 cm x 60.5 cm x 87.4 cm	181 kg	23.6 kg	1

WHEN ORDERING PRODUCTS WITH BOLD COLOR CODES, PLEASE SPECIFY COLOR CODE AFTER THE PRODUCT NUMBER. REFER TO THE PRODUCT COLOR GUIDE AT THE BACK OF THE CATALOG.

Executive Service Cart

The Executive Service Cart is an elegant and versatile solution for back- and front-of-house tasks. With 20% more top-shelf capacity, it's constructed of durable, recyclable polyethylene and it's easy to clean—keeping your business looking smart for years.



ERGONOMIC ROUNDED HANDLES

Improves maneuverability and comfort.

WRAPAROUND END PANELS

Conceals cart contents.

SOLID ROUNDED BUMPER

Gentle on walls and furniture.

300-LB LOAD CAPACITY
Holds 100 lbs per shelf.



FG9T6800

No.	Color	Description	Dimensions	US Capacity	US Ship Wt.	Metric Dimensions	Metric Capacity	Metric Ship Wt/Ctn	Pack
FG9T6800	PLAT, BLA	Executive Service Cart	39" l x 21" w x 38" h	300 lbs	31.5 lb	99.1 cm x 53.3 cm x 96.5 cm	136 kg	14.3 kg	1

ACCESSORIES

No.	Color	Description	Dimensions	US Capacity	US Ship Wt.	Metric Dimensions	Metric Capacity	Metric Ship Wt/Ctn	Pack
FG335388	BLA	Refuse Bin	12" l x 17" w x 22" h	8 gal	9.0 lb	30.5 cm x 43.2 cm x 55.9 cm	30.3 L	4.1 kg	2
FG335488	BLA	Utility Bin	12.12" l x 17" w x 10.5" h	4 gal	5.4 lb	30.8 cm x 43.2 cm x 26.7 cm	15.1 L	2.4 kg	2
FG334900*	WHT, GRAY	Bus/Utility Box	20" l x 15" w x 5" h	4.625 gal	20.6 lb	50.8 cm x 38.1 cm x 12.7 cm	17.5 L	9.3 kg	12

*Certified to NSF Standard #2 for food contact.

Service Cart

Versatile, durable cart performs a wide variety of tasks.

- Molded shelves won't rust, dent, or require painting
- Plastic construction is easy to clean and minimizes noise
- Convenient handles and compact size enhance maneuverability
- Nonmarking swivel casters reduce touch-up cleaning



FG342488

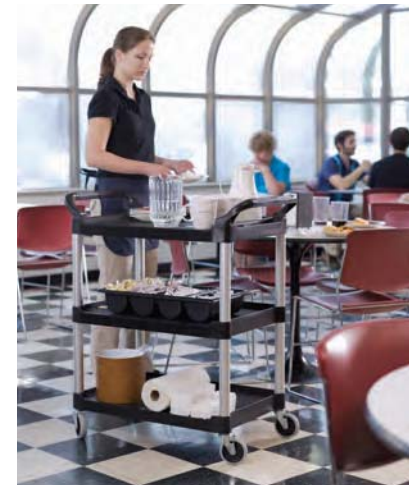

Stylish utility cart with metal uprights and large 4" casters holds up to 200 lbs (90.7 kg).

No.	Color	Description	U.S. Dimensions	U.S. Capacity	U.S. Ship Wt/Ctn	Metric Dimensions	Metric Capacity	Metric Ship Wt/Ctn	Pack
FG342488	RED, PLAT, OWHT, BLA	Utility Cart with 4" dia (10.2 cm) Swivel Casters	33.63" l x 18.63" w x 37.75" h	200 lb	30.0 lb	85.4 cm x 47.3 cm x 95.9 cm	90.7 kg	13.6 kg	1

Xtra™ Carts

Durable and attractive storage and transportation for front- and back-of-house applications.

- Metal uprights and molded shelves engineered for durability and appearance
- Nonmarking 4" swivel casters
- Wide shelves hold a variety of equipment and supplies, up to 300 lbs
- Available with locking doors and enclosure panels
- Available accessories include refuse and utility bins

CART ACCESSORIES
see "Cart Accessories"



FG409100



FG409300



FG409100

No.	Color	Description	U.S. Dimensions	U.S. Capacity	U.S. Ship Wt/Ctn	Metric Dimensions	Metric Capacity	Metric Ship Wt/Ctn	Pack
FG409100	OWHT, GRAY, BLA	Utility Cart, Open-Sided	40.63" l x 20" w x 37.8" h	300 lb	43.4 lb	103.2 cm x 50.8 cm x 96 cm	136.1 kg	19.7 kg	1
FG409300	OWHT, BLA	Utility Cart with Enclosed End Panels on 3 Sides	40.63" l x 20" w x 37.8" h	300 lb	51.6 lb	103.2 cm x 50.8 cm x 96 cm	136.1 kg	23.6 kg	1

Heavy-Duty Utility Carts

Transport materials, supplies, and heavy loads in almost any environment.



CART ACCESSORIES
see "Cart Accessories"



FG452500

FG452088

■ **LARGE WORK SURFACE**
Flat top shelf for oversized loads and smarter work surface.

■ **MANEUVER SAFELY**
Variable grip-height handle improves control and worker safety.

■ **KEEP LOADS SECURE**
Deep pocket shelves keep contents in place.



HEAVY-DUTY UTILITY CARTS

No.	Color	Description	U.S. Dimensions	U.S. Capacity	U.S. Ship Wt/Ctn	Metric Dimensions	Metric Capacity	Metric Ship Wt/Ctn	Caster Type	Pack
FG450088	BLA, BEIG	HD 2-Shelf Utility Cart w/ Lipped Shelf (Small)	39" l x 17.88" w x 33.25" h	500 lb	29.5 lb	99.1 cm x 45.4 cm x 84.5 cm	226.8 kg	13.4 kg	5" TPR	1
FG452088	BLA, BEIG	HD 2-Shelf Utility Cart w/ Lipped Shelf (Med)	44" l x 25.25" w x 39" h	500 lb	41.0 lb	111.8 cm x 64.1 cm x 99.1 cm	226.8 kg	18.6 kg	5" TPR	1

HEAVY-DUTY FLAT-SHELF UTILITY CARTS

No.	Color	Description	U.S. Dimensions	U.S. Capacity	U.S. Ship Wt/Ctn	Metric Dimensions	Metric Capacity	Metric Ship Wt/Ctn	Caster Type	Pack
FG450500	BLA, BEIG	HD 2-Shelf Utility Cart Flat Shelf (Small)	37.88" l x 19.2" w x 33.3" h	500 lb	29.5 lb	96.2 cm x 48.8 cm x 84.6 cm	226.8 kg	13.4 kg	5" TPR	1
FG452500	BLA, BEIG	HD 2-Shelf Utility Cart Flat Shelf (Med)	43.88" l x 25.88" w x 33.3" h	500 lb	41.0 lb	111.5 cm x 65.7 cm x 84.6 cm	226.8 kg	18.6 kg	5" TPR	1

WHEN ORDERING PRODUCTS WITH **BOLD** COLOR CODES, PLEASE SPECIFY COLOR CODE AFTER THE PRODUCT NUMBER. REFER TO THE PRODUCT COLOR GUIDE AT THE BACK OF THE CATALOG.

Heavy-Duty Platform Truck

Ideal for moving large, heavy, oversized loads in a variety of environments throughout your foodservice operation.

IMPROVED MANEUVERABILITY
Variable grip-height handle improves control and worker safety.

VIRTUALLY MAINTENANCE-FREE
Powder-coated steel creates a hard finish that is far tougher than conventional paint.

SECURE SMALL ITEMS
Perimeter deck channel retains small items.

KEEP LOADS IN PLACE
Textured deck surface reduces load slippage.

RUGGED CONSTRUCTION
Duramold's™ exclusive, precision-engineered resin and metal composite structure provides maximum load support.

BETTER LOAD RETENTION
Four molded-in tie-down slots for securing loads with tie-down straps or bungees.

FG440300

See it in ACTION
www.rcpmaterialhandling.com



No.	Color	Description	U.S. Dimensions	U.S. Capacity	U.S. Ship Wt/Ctn	Metric Dimensions	Metric Capacity	Metric Ship Wt/Ctn	Caster Type	Pack
FG440300	BLA	HD Platform Truck (Sm 24" x 36")	36" l x 24" w	1000 lb	50.0 lb	91.4 cm x 61 cm	453.6 kg	22.7 kg	6" TPR	1
FG443600	BLA	HD Platform Truck (Med 24" x 48")	48" l x 24" w	2000 lb	70.0 lb	121.9 cm x 61 cm	907.2 kg	31.8 kg	8" TPR	1

Triple® Trolley

Efficiently transports large, bulky loads, then folds flat for easy storage.

- Sturdy structural foam deck won't rust, dent, chip, or peel
- Nonskid platform surface helps prevent load shifting
- Three-position handle lets users push, pull, or fold flat for use as a dolly
- Casters are nonmarking



No.	Color	Description	U.S. Dimensions	U.S. Capacity	U.S. Ship Wt/Ctn	Metric Dimensions	Metric Capacity	Metric Ship Wt/Ctn	Pack
FG440100	BLA	Triple® Trolley, Standard Duty with User-Friendly Handle and 5" dia x 7/8" w (12.7 cm x 2.22 cm) Casters	32.5" l x 20.5" w	500 lb	25.4 lb	82.6 cm x 52.1 cm	226.8 kg	11.5 kg	1

Stack & Nest Palletote® Boxes

For cost-effective storage and transportation.

- Nestable for efficient storage and transport; stackable with and without lids
- Rounded corners and smooth surfaces are easy to clean
- USDA 3A (Dairy) Sanitary Standards and Meat and Poultry Equipment Group listed
- Materials are FDA-compliant for food contact and certified to NSF Std. #2



No.	Color	Description	U.S. Dimensions	U.S. Capacity	U.S. Ship Wt/Ctn	Metric Dimensions	Metric Capacity	Metric Ship Wt/Ctn	Pack
FG172100	GRAY	Palletote® Box	19.5" l x 15.5" w x 10" h	1.3 cu ft	42.6 lb	49.5 cm x 39.4 cm x 25.4 cm	.04 m³	19.3 kg	10
FG172200	GRAY	Palletote® Box	19.5" l x 15.5" w x 13" h	1.6 cu ft	57.9 lb	49.5 cm x 39.4 cm x 33 cm	.05 m³	26.3 kg	10
FG173100	GRAY	Palletote® Box	23.5" l x 19.5" w x 10" h	2 cu ft	60.6 lb	59.7 cm x 49.5 cm x 25.4 cm	.06 m³	27.5 kg	10
FG173200	GRAY	Palletote® Box	23.5" l x 19.5" w x 13" h	2.6 cu ft	92.2 lb	59.7 cm x 49.5 cm x 33 cm	.07 m³	41.8 kg	10

LIDS

No.	Color	Description	U.S. Dimensions	U.S. Ship Wt/Ctn	Metric Dimensions	Metric Ship Wt/Ctn	Pack
FG172000	GRAY	Palletote® Lid for FG172100, FG172200	19.62" l x 15.62" w x 1" h	16.1 lb	49.8 cm x 39.7 cm x 2.5 cm	7.3 kg	10
FG173000	GRAY	Palletote® Lid for FG173100, FG173200	23.75" l x 19.75" w x 1" h	22.1 lb	60.3 cm x 50.2 cm x 2.5 cm	10 kg	10

Bus/Tote Boxes

Built for long-lasting durability.

- Commercial-grade plastic has reinforced handles, bottom, and ribs for added strength and employee safety
- Rounded corners for easy cleaning
- NSF 3-A and 2-certified
- Commercial dishwasher-safe



FG335100



No.	Color	Description	U.S. Capacity	U.S. Dimensions	U.S. Ship Wt/Ctn	Metric Capacity	Metric Dimensions	Metric Ship Wt/Ctn	Case Pack
FG334900 ^a	WHT GRAY	Bus/Utility Box	4 $\frac{1}{2}$ gal	20" l x 15" w x 5" h	20.6 lbs	17.5 L	50.8 cm x 38.1 cm x 12.7 cm	9.3 kg	12
FG334992 ^a	WHT GRAY	Bus/Utility Box, Bulk Pack	4 $\frac{1}{2}$ gal	20" l x 15" w x 5" h	444.1 lbs	17.5 L	50.8 cm x 38.1 cm x 12.7 cm	201.4 kg	210
FG335000 ^a	BRN	Divided Bus/Utility Box	7 gal	21.5" l x 17.13" w x 7" h	20.6 lbs	26.5 L	54.6 cm x 43.5 cm x 17.8 cm	9.3 kg	6
FG335100 ^a	GRAY BRN	Undivided Bus/Utility Box	7 $\frac{1}{2}$ gal	21.5" l x 17.13" w x 7" h	17.6 lbs	28.9 L	54.6 cm x 43.5 cm x 17.8 cm	8 kg	6
FG335192 ^a	GRAY BRN	Undivided Bus/Utility Box, Bulk Pack	7 $\frac{1}{2}$ gal	21.5" l x 17.13" w x 7" h	335 lbs	28.9 L	54.6 cm x 43.5 cm x 17.8 cm	152 kg	100
FG369000 ^a	WHT	Food/Tote Box	11 qt	14.38" l x 12.38" w x 5.38" h	6.7 lbs	10.4 L	36.5 cm x 31.4 cm x 13.7 cm	3 kg	6
FG364800	GRAY	Lid for FG334900 Bus/Utility Box	N/A	22" l x 16.5" w x 0.75" h	18 lbs	N/A	55.9 cm x 41.9 cm x 1.9 cm	8.2 kg	12
FG361600 ^a	WHT	Lid for FG369000 Food/Tote Box	N/A	15" l x 12.75" w	2.9 lbs	N/A	38.1 cm x 32.4 cm	1.3 kg	6

^aCertified to NSF Std. 2 for food contact. ^b Not NSF-certified.

Cutlery Bin

Safely stores and transports cutlery to minimize employee injuries.

- Made of durable, commercial-grade plastic
- Ribbed design and special resin finish for strength
- Ideal for storing, dispensing, and transporting silverware and condiment packets
- NSF-certified and commercial dishwasher-safe



FG336200

No.	Color	Description	U.S. Dimensions	U.S. Ship Wt/Ctn	Metric Dimensions	Metric Ship Wt/Ctn	Case Pack
FG336200	GRAY	Cutlery Bin, 4 Compartments	21.25" l x 11.5" w x 3.75" h	19.1 lbs	54 cm x 29.2 cm x 9.5 cm	8.7 kg	12

Condiment Dispensers

Hygienic, safe storage for condiments, garnishes, and more.

- Comes with three 1-quart (.9-L) or six 1-pint (.5-L) removable inserts
- Textured, see-through lid made of durable crystal-clear polycarbonate for durability and ingredient identification
- Convenient finger tab for opening lid
- For use in front of house or back of house for prep work, condiments, garnishes, and ingredients
- Commercial dishwasher-safe



FG289000

No.	Color	Description	U.S. Dimensions	U.S. Ship Wt/Ctn	Metric Dimensions	Metric Ship Wt/Ctn	Case Pack
FG289000	BLA	Condiment Dispenser with Six 1 U.S. pt (0.5 L) Inserts	19.63" l x 6.25" w x 3.75" h	3.23 lbs	49.8 cm x 15.9 cm x 9.5 cm	1.5 kg	1
FG289100	BLA	Condiment Dispenser with Three 1 U.S. qt (0.9 L) Inserts	19.63" l x 6.25" w x 3.75" h	3.03 lbs	49.8 cm x 15.9 cm x 9.5 cm	1.4 kg	1

Bouncer® Pitchers

Designed for safety and lower replacement costs.

- Reduce potential contamination with durable crystal-clear pitchers that resist chipping and breaking
- Drip-proof spout
- Lighter weight for employee safety and less costly than glass
- NSF-certified and commercial dishwasher-safe



FG333400



FG333800

No.	Color	Description	U.S. Capacity	U.S. Ship Wt/Ctn	Metric Capacity	Metric Ship Wt/Ctn	Case Pack
FG333100	CLR	Bouncer® II Pitcher	48 oz	6.67 lbs	1.4 L	3 kg	6
FG333400	CLR	Bouncer® II Pitcher	60 oz	6.49 lbs	1.8 L	2.9 kg	6
FG333500	CLR	Bouncer® Pitcher	48 oz	4.86 lbs	1.4 L	2.2 kg	6
FG333600	CLR	Bouncer® Pitcher	32 oz	3 lbs	0.9 L	1.4 kg	6
FG333700	CLR	Bouncer® Pitcher	54 oz	5.49 lbs	1.6 L	2.5 kg	6
FG333800	CLR, GOLD	Bouncer® Pitcher	60 oz	5.72 lbs	1.8 L	2.6 kg	6
FG333900	CLR	Bouncer® Pitcher	72 oz	6.63 lbs	2.1 L	3 kg	6

Covered Pitchers

Suitable for any operation.

- Tight-fitting, three-way lid features open, closed, and slotted positions
- Rugged polyethylene construction
- Commercial dishwasher-safe
- Mixing Pitcher (FG306409) is NSF-certified and reduces cross-contamination with integrated stirrer
- Front of house: serving juice, iced tea, water
- Back of house: pouring, storing batters



1777155



FG3062PR



FG3063PR



FG306409

No.	Color	Description	U.S. Capacity	U.S. Ship Wt/Ctn	Metric Capacity	Metric Ship Wt/Ctn	Case Pack
FG3062PR	PERI	Economy Pitcher	2.5 qt	4.65 lbs	2.1 L	2.1 kg	6
FG3063PR	PERI	Economy Pitcher	1 gal	6.4 lbs	3.8 L	2.9 kg	6
FG3063RD	WHT	Economy Pitcher	1 gal	6.4 lbs	3.8 L	2.9 kg	6
1777155	CLR	Economy Pitcher	1 gal	6.4 lbs	3.8 L	2.9 kg	6
7E6000	KIWI	Economy Pitcher	1 gal	6.4 lbs	3.8 L	2.9 kg	4
7E60RD	CHILI	Economy Pitcher	1 gal	6.4 lbs	3.8 L	2.9 kg	4
FG306409*	WHT	Mixing Pitcher	2 qt	3.7 lbs	1.9 L	1.7 kg	6

*Certified to NSF Standard #2.

Beverage Dispensers

Versatile and economical noncarbonated beverage dispensing.

- Two sizes: 3- and 5-gallon (11.4-L and 18.9-L) capacities
- Available in amber tint for iced tea, and clear for punch, lemonade, etc.
- Interchangeable, durable tanks
- Includes tank, base, drain tray, lid, and labels for lemonade and iced tea
- Certified to NSF Std. #18



FG335800



FG335900

No.	Color	Description	U.S. Capacity	U.S. Dimensions	U.S. Ship Wt/Ctn	Metric Capacity	Metric Dimensions	Metric Ship Wt/Ctn	Case Pack
FG335800	AMBER, CLR	Beverage Dispenser	3 gal	16.75" l x 10.38" w x 23.38" h	10.61 lbs	11.4 L	42.5 cm x 26.4 cm x 59.4 cm	4.8 kg	1
FG335900	CLR	Beverage Dispenser	5 gal	16.75" l x 10.38" w x 22.75" h	12.61 lbs	18.9 L	42.5 cm x 26.4 cm x 57.8 cm	5.7 kg	1

Insulated Cold Beverage Dispensers

Keeps beverages cold for hours.

- Durable polyethylene material for crack resistance and long life
- Improved recessed spigot and convenient carry handles



1840999



No.	Color	Description	U.S. Capacity	U.S. Dimensions	U.S. Ship Wt/Ctn	Metric Capacity	Metric Dimensions	Metric Ship Wt/Ctn	Case Pack
FG16830111	ORAN	Insulated Beverage Dispenser	3 gal	12.5" l x 11" w x 16.7" h	6 lbs	11.4 L	31.8 cm x 27.9 cm x 42.4 cm	2.7 kg	1
1840999	ORAN	Insulated Beverage Dispenser	5 gal	14.75" l x 12.88" w x 18.88" h	8 lbs	18.9 L	37.5 cm x 32.7 cm x 47.9 cm	3.6 kg	1
FG16100111	ORAN	Insulated Beverage Dispenser	10 gal	16.1" l x 16" w x 20.5" h	11.5 lbs	37.8 L	40.6 cm x 40.6 cm x 52.1 cm	5.2 kg	1

Sturdy Chair™ Youth Seats with Microban® Antimicrobial Protection

Sturdy Chair™ Youth Seats make safety and cleanliness a priority for your youngest patrons.

- Contemporary design with Microban® technology makes it easier to clean than wood
- Microban® provides all-over protection from bacteria growth that can cause odors and staining; complies with FDA standards
- Meets ASTM 404-08, TUV, and European safety standards
- Stackable design makes for easy storage
- Fits under standard table without tray
- 3-point harness with one-hand release



ASTM F404-08 and TUV Certification Standard Consumer Safety Specifications for high chairs that ensures the design and function of the Sturdy Chair™ Youth Seat meets safety specifications intended to minimize injuries to children under normal use.



FG781588 STURDY CHAIR™ TRAY AVAILABLE IN DARK BLUE, PLATINUM, DARK GREEN, RED, BROWN, AND BLACK.



■ Convenient handle for safe, one-handed maneuvering throughout dining room

■ One-piece T-bar and safety harness safely helps to secure child



*2006 Rubbermaid Study



- Microban® antimicrobial protection helps prevent the growth of stain- and-odor causing bacteria
- Microban® protection is built into the chair during the manufacturing process and will not wash or wear off during the life of the chair
- Sturdy Chair™ looks newer longer with built-in Microban® antimicrobial protection

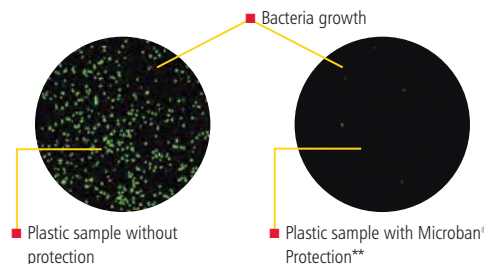

REPRESENTATIVE OF ANTIMICROBIAL EFFECT – 24-HOUR ELAPSED TIME

This information is based upon standard laboratory tests and is provided for comparative purposes to substantiate antimicrobial activity for nonpublic health applications. Microban® technology is not designed to replace good building practices or protect users from disease-causing microorganisms. Antimicrobial action limited to product surfaces.

No.	Color	Description	U.S. Dimensions	U.S. Ship Wt/Ctn	Metric Dimensions	Metric Ship Wt/Ctn	Case Pack
FG780508	DGRN, PLAT, BLA	Sturdy Chair™ Youth Seat with Wheels	23.5" l x 23.38" w x 29.75" h	18 lbs	59.7 cm x 59.4 cm x 75.6 cm	8.2 kg	1
FG780608	DGRN, PLAT, BLA	Sturdy Chair™ Youth Seat without Wheels	23.5" l x 23.5" w x 29.75" h	18 lbs	59.7 cm x 59.7 cm x 75.6 cm	8.2 kg	1
FG781408	DGRN, PLAT, BLA	Sturdy Chair™ Youth Seat, RTA (ready to assemble), No Wheels	23.5" l x 23.5" w x 29.75" h	17 lbs	59.7 cm x 59.7 cm x 75.6 cm	7.7 kg	1
FG781588	DBLU, DGRN, PLAT, RED, BRN, BLA	Tray for FG780508, FG780608, and FG781408 Chairs	11.5" l x 18.5" w x 3.25" h	2.5 lbs	29.2 cm x 47 cm x 8.3 cm	1.1 kg	1

MICROBAN® is a registered trademark of Microban Products Company. ©2006 Microban Products Company. All rights reserved. www.microban.com

Microban® protection does not protect user from foodborne illness and is not a substitute for normal cleaning practices. **Time lapse image.

WHEN ORDERING PRODUCTS WITH BOLD COLOR CODES, PLEASE SPECIFY COLOR CODE AFTER THE PRODUCT NUMBER. REFER TO THE PRODUCT COLOR GUIDE AT THE BACK OF THE CATALOG.

Baby Changing Stations with Antimicrobial Protection

Horizontal and vertical baby changing stations.

- Meets all global safety standards (ASTM, ADA, and EN)
- Surface contains antimicrobial protection from bacteria growth
- Easy-reach hooks
- Built-in shelf and liner storage



FG781888



FG781988

No.	Color	Description	U.S. Dimensions	U.S. Ship Wt/Ctn	Metric Dimensions	Metric Ship Wt/Ctn	Pack
FG781788	WHT	Protective Liners for Baby Changing Stations, Laminated 2-Ply Tissue Paper	13.25" l x 5.5" w x 0" h	4.8 lb	33.7 cm x 14 cm x 0 cm	2.2 kg	1/320 Ctn
FG781888	LPLAT	Baby Changing Station Horizontal	33.25" l x 21.5" w x 4" h	23.5 lb	84.5 cm x 54.6 cm x 10.2 cm	10.7 kg	1
FG781988	LPLAT	Baby Changing Station Vertical	23" l x 34.1" w x 4" h	25.0 lb	58.4 cm x 86.6 cm x 10.2 cm	11.3 kg	1

For more Foodservice cleaning and utility refuse products, see:

WaveBrake® Mopping Systems

PULSE™ Mopping Kit

Slim Jim® Containers













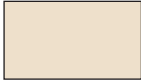





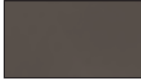



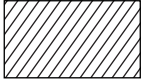

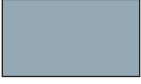





















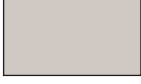











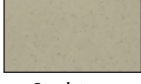





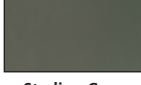





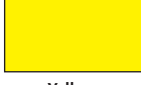





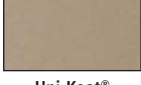

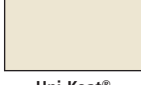

Common Metric–English Conversions

Measurement	Multiply	by	to get:
Linear	centimeters (cm)	0.3937	inches
	inches (in. / ")	2.54	centimeters
	meters (m)	3.2804	feet
	feet (ft. /')	0.3048	meters
Area	centimeters ² (cm ²)	0.155	inches ²
	inches ² (in ²)	6.4516	centimeters ²
	meters ² (m ²)	10.76391	feet ²
	feet ² (ft ²)	0.092903	meters ²
Volume	centimeters ³ (cm ³)	0.06102	inches ³
	inches ³	16.387	centimeters ³
	milliliters	0.033814	fluid ounces
	fluid ounces	29.5735	milliliters
	liters	0.26417	gallons
	gallons	3.78541	liters
Mass	kilogram (kg)	2.2046	pounds
	pounds (lbs.)	0.4536	kilograms
	grams (g)	0.035274	ounces
	ounces (oz.)	28.3495	grams

Metric Temperature Conversion to Get:

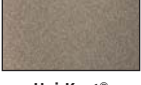
Degrees Celsius (C°)	$\frac{5 \times (\text{degrees F} - 32)}{9}$
Degrees Fahrenheit (F°)	$\frac{(9 \times \text{degrees C})}{5} + 32$

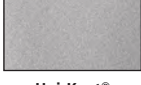
							
Aged Bronze AGBRNZ	Antique Pewter ATPWTR	Almond ALMD	Aluminum ALUM	Amber AMBR	Beige BEIG	Black BLA/BK00/38	Blue BLUE/BLOO
							
Brass on Mirror Stainless BSSTL	Bronze BRNZ	Brown BRN	Brown Stone BSTONE	Charcoal CHAR	Chrome CHRM	Clear CLR	Cobalt COBLT
							
Cool Gray CGRAY	Coral CORL	Cream Granite CGRAN	Cylinder CYLND	Dark Blue DBLUE	Dark Green DGRN	Deep Charcoal Marble CMARB	Designer Black DEBLA
							
Designer Crimson DECRS	Designer Green DEGRN	Driftwood DWOOD	Gold GOLD	Gray GRAY/GY00/331	Gray Metallic Burl BGRAY	Green GRN/GR00/714	Hammered Silver HSILV
							
Lacquer LAC	Landmark Steel/ Brown BRN	Landmark Steel/ Brown/Brown BBRN	Landmark Steel/ Gray GRAY	Landmark Steel/ Green GRN	Light Gray LGRAY	Light Platinum LPLAT	Mirror Stainless MSSTL
							
Natural NAT	Natural (Foodservice) NAT	No Color 0000	Off-White OWHT	Orange ORAN/OR00/11	Periwinkle PERI	Platinum PLAT/907	Red RED/RD00
							
River Rock Rock	Sable SBLE	Sandstone SSTON	Satin Aluminum SALUM	Satin Stainless SSSTL	Silver SILV	Stainless Steel SSSTL/SSS/SS	Stainless Steel/ Black Top SSBLA
							
Steel STL	Sterling Gray SGRAY	Tan TAN	Teal TEAL	Warm Black Mist WBKMT	White WHT/WH00	White Granite WGRAN	Yellow YEL/YL00
							
Uni-Koat® Crimson	Uni-Koat® Red	Uni-Koat® Empire Green	Uni-Koat® Cobalt Blue	Uni-Koat® Silver Metallic	Uni-Koat® Desert Pearl	Uni-Koat® Anth	Uni-Koat® Almond
							
Uni-Koat® Brown	Uni-Koat® Arch Bronze	Uni-Koat® Black	Uni-Koat® White	Uni-Koat® Gray	Uni-Koat® Beige	Uni-Koat® Spruce Green	Uni-Koat® Textured Black
							
Uni-Koat® Textured Gray	Uni-Koat® Textured Bronze	Uni-Koat® Textured Green	Uni-Koat® Textured Gray				

Sortation Decals

Ensure proper disposal of waste and recyclables.

- Available in black or white
- Available in various sizes to meet your requirements
- Metal units only



FGDR13



FGDR2



FGDR1

- GLASS
- PLASTIC
- CANS
- WHITE PAPER ONLY
- GLASS / CANS / PLASTIC
- PAPER
- TRASH
- CANS / PLASTIC
- ORGANIC
- TRASH
- RECYCLE
- RECYCLE

1792975 Recycling Label Kit. See Utility Refuse section.
Sized for plastic units only.

GLASS ONLY FGRSB1
 TRASH FGRSB4
 COMPUTER FGRC7
 CANS ONLY FGRSB2
 PAPER ONLY FGRSB5
 COLORED FGRC8
 PLASTIC FGRSB3
 NEWSPAPER FGRC6
 WHITE PAPER FGRC9
 CANS AND BOTTLES FGDRB10
 NEWSPAPER FGDRB6
 TRASH FGDRB4

WHITE LETTER DECALS – PRINTED ON CLEAR DECAL

No.	Description	U.S. Dimensions	Metric Dimensions
FGRSW1	Recycle Decals "GLASS ONLY"	8" w x 1" h	20.3 cm x 2.5 cm
FGRSW2	Recycle Decals "CANS ONLY"	8" w x 1" h	20.3 cm x 2.5 cm
FGRSW3	Recycle Decals "PLASTIC ONLY"	8" w x 1" h	20.3 cm x 2.5 cm
FGRSW4	Recycle Decals "TRASH ONLY"	8" w x 1" h	20.3 cm x 2.5 cm
FGRSW5	Recycle Decals "PAPER ONLY"	8" w x 1" h	20.3 cm x 2.5 cm
FGRSW6	Recycle Decals "COMPUTER PAPER ONLY"	8" w x 1" h	20.3 cm x 2.5 cm
FGRC1	Recycle Decals "GLASS ONLY"	13.5" w x 1.75" h	34.3 cm x 4.4 cm
FGRC2	Recycle Decals "CANS ONLY"	13.5" w x 1.75" h	34.3 cm x 4.4 cm
FGRC3	Recycle Decals "PLASTIC ONLY"	13.5" w x 1.75" h	34.3 cm x 4.4 cm
FGRC4	Recycle Decals "TRASH ONLY"	13.5" w x 1.75" h	34.3 cm x 4.4 cm
FGRC5	Recycle Decals "PAPER ONLY"	13.5" w x 1.75" h	34.3 cm x 4.4 cm
FGRC6	Recycle Decals "NEWSPAPER ONLY"	13.5" w x 1.75" h	34.3 cm x 4.4 cm
FGRC7	Recycle Decals "COMPUTER PAPER ONLY"	13.5" w x 1.75" h	34.3 cm x 4.4 cm
FGRC8	Recycle Decals "COLORED PAPER ONLY"	13.5" w x 1.75" h	34.3 cm x 4.4 cm
FGRC9	Recycle Decals "WHITE PAPER ONLY"	13.5" w x 1.75" h	34.3 cm x 4.4 cm
FGRDW4	Recycle Decals for Classics "TRASH"	6.5" w x 1.5" h	16.5 cm x 3.8 cm
FGRDW6	Recycle Decals for Classics "NEWSPAPER"	8.25" w x 4.75" h	21 cm x 12.1 cm
FGRDW10	Recycle Decals for Classics "CANS AND BOTTLES"	8.75" w x 3.5" h	22.2 cm x 8.9 cm

BLACK LETTER DECALS – PRINTED ON CLEAR DECAL

No.	Description	U.S. Dimensions	Metric Dimensions
FGRSB1	Recycle Decals "GLASS ONLY"	1" h	2.5 cm
FGRSB2	Recycle Decals "CANS ONLY"	1" h	2.5 cm
FGRSB3	Recycle Decals "PLASTIC ONLY"	1" h	2.5 cm
FGRSB4	Recycle Decals "TRASH ONLY"	1" h	2.5 cm
FGRSB5	Recycle Decals "PAPER ONLY"	1" h	2.5 cm
FGDRB4	Recycle Decals for Classics "TRASH"	6.5" w x 1.5" h	16.5 cm x 3.8 cm
FGDRB6	Recycle Decals for Classics "NEWSPAPER"	8.25" w x 4.75" h	21 cm x 12.1 cm
FGDRB10	Recycle Decals for Classics "CANS AND BOTTLES"	8.75" w x 3.5" h	22.2 cm x 8.9 cm

SILHOUETTE RECYCLING DECALS – DIE-CUT DECAL (CUTOUT)

No.	Description	U.S. Dimensions	Metric Dimensions
FGDRL1	Sortation Decals "Trash"	19" w x 4.75" h	48.3 cm x 12.1 cm
FGDRL2	Sortation Decals "Cans & Bottles"	19" w x 4.75" h	48.3 cm x 12.1 cm
FGDRL3	Sortation Decals "Newspaper"	19" w x 4.75" h	48.3 cm x 12.1 cm
FGDRD1	Sortation Decals "Trash"	19" w x 4.75" h	48.3 cm x 12.1 cm
FGDRD2	Sortation Decals "Cans & Bottles"	19" w x 4.75" h	48.3 cm x 12.1 cm
FGDRD3	Sortation Decals "Newspaper"	19" w x 4.75" h	48.3 cm x 12.1 cm

RECYCLING DECALS – TEXT ON COLOR

No.	Description	U.S. Dimensions	Metric Dimensions
FGNCL1	Recycling Decals "Glass"	N/A	N/A
FGNCL2	Recycling Decals "Cans"	N/A	N/A
FGNCL3	Recycling Decals "Plastic"	N/A	N/A
FGNCL4	Recycling Decals "Waste"	N/A	N/A
FGNCL5	Recycling Decals "Paper"	N/A	N/A
FGNCL6	Recycling Decals "Newspaper"	N/A	N/A
FGNCL10	Recycling Decals "Mixed Office Paper"	N/A	N/A
FGNCL11	Recycling Decals "Confidential"	N/A	N/A



FGCL1

SOILED LINEN
ROPA SUCIA

FGCL2

TRASH ONLY
BASURA SOLAMENTE

FGCL3

INFECTIOUS WASTE
BASURA INFECCIOSA

FGCL4



FGCD1



FGBP1

MEDICAL WASTE DECALS (for metal units only)

No.	Description	U.S. Dimensions	Metric Dimensions
FGCL1	English/Spanish Label "BioHazard"	10" w x 7" h	25.4 cm x 17.8 cm
FGCL2	English/Spanish Label "Soiled Linen"	10" w x 4" h	25.4 cm x 10.2 cm
FGCL3	English/Spanish Label "Trash Only"	10" w x 4" h	25.4 cm x 10.2 cm
FGCL4	English/Spanish Label "Infectious Waste"	10" w x 4" h	25.4 cm x 10.2 cm
FGCD1	Decal "Chemotherapy Waste"	6" w x 6" h	15.2 cm x 15.2 cm
FGBP1	Label "BioHazard"	6" w x 6" h	15.2 cm x 15.2 cm

WASTE CONTAINER SMOKING ACCESSORIES

Description	Model Number	For Use with
10" Dia. Urn Cap	FGC10	All 10" Dia. Urns
Black Sand five 5-lb Bags	FGB25	All Sand Urns
White Silica Sand five 5-lb Bags	FGS25	All Sand Urns
Weather Urn Tops	FGWU	FGR40, FGR41
	FGWU1	FGR12SU, FGR14SU
	FGWU3	FGR18SU
Flip-Top Urn	FGFT10BA	All 10" Dia. Urns

WASTE CONTAINER ANCHORING KITS/ACCESSORIES

Description	Model Number	For Use with
Anchoring Kit	FGKR12	FGMT12, FGMT22, FGMT32
	FGKR30	FGR18SU, FGR34, FGT1414, FGT1424, FGT1940
	FGKR38	FGA50, FGA51, FGA17, FGA38, FGR36, FGR38, FGR48
	FGKR55	FGH55, FGH55E, FGR23, FGR25, FGR56
	FGKRS55	FGS3, FGS55, FGSM1, FGSM3, FGSM7
	FGFG1	All Fiberglass Models (excluding lift-off models)
	Anchoring Kit (concrete)	FGKR52C
Anchoring Kit (ground)	FGKR52G	FGSBR52
Anchoring Bolt	FGAB1	FGR12, FGR14, FGR40, FGR41
Anchoring Bolt	FGAB2	FGR1639E

WASTE CONTAINER ACCESSORIES

Description	Model Number	For Use with
ABS Plastic Lid	FGAB55	FGH55E, FGS55
Recessed Steel Base	FGOB55	FGH55E, FGS55

FACTORY-INSTALLED OPTIONS

Description	Model Number	For Use with
Weather Urn Top	FGWU	FGR34, FGR36, FGR38, FGR48



WASTE CONTAINER ACCESSORIES

These special options are designed to meet every need.



10" URN CAP
FGC10



SAND
See below.



ANCHORING KIT
See below.



ABS PLASTIC LID
FGAB55



FLIP TOP URN
FGFT10BA



WEATHER URN TOP
FGWU



WEATHER URN TOP
See below.



RECESSED STEEL BASE
FGOB55



For galvanized liner options, please contact your Rubbermaid Commercial Products' Sales Representative or call 1-800-347-9800. For plastic liners, refer to the Decorative Refuse section.

FIBERGLASS COLOR AND FINISH OPTIONS

FIBERGLASS SERIES STANDARD GEL-COAT COLORS – INDOOR/OUTDOOR USE



PREMIUM FINISHES

All standard colors shown at right are available in Sand-x™ and Matte finishes. Upcharges may apply.

Examples shown below.

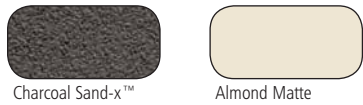

PREMIUM COLORS

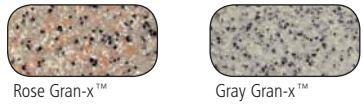

CUSTOM COLORS AVAILABLE.

Colors shown are as accurate as the printing process allows.

FIBERGLASS PREMIUM DURA-TONE™ FINISH – INDOOR USE ONLY

DURA-TONE™

FIBERGLASS FINISH

EXTRA-DURABLE FINISH PROVIDES A SOPHISTICATED COMBINATION OF TEXTURE AND COLORS.

- Recommended for indoor use
- Ideal for high-traffic areas
- Superior resistance to stains and scratches
- Seamless construction
- Available on all fiberglass models; upcharges may apply

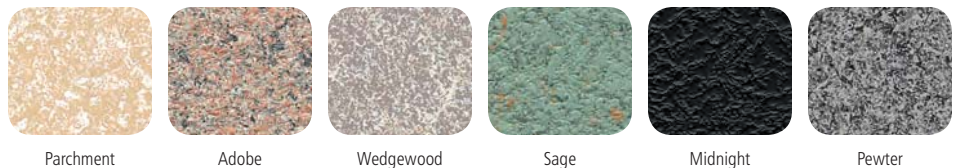

FIBERGLASS PREMIUM CONCRETE FINISH – INDOOR/OUTDOOR USE



Sand



Slate



Pebble



CONCRETE FIBERGLASS FINISH IS TEXTURED TO HAVE THE LOOK AND FEEL OF CONCRETE AT A FRACTION OF THE WEIGHT. ITS RUGGED DURABILITY MAKES IT IDEAL FOR OUTDOOR USE.

- Withstands heavy, constant use
- Superior resistance to stains and scratches
- Seamless construction
- Standard for all Cornerstone® fiberglass models

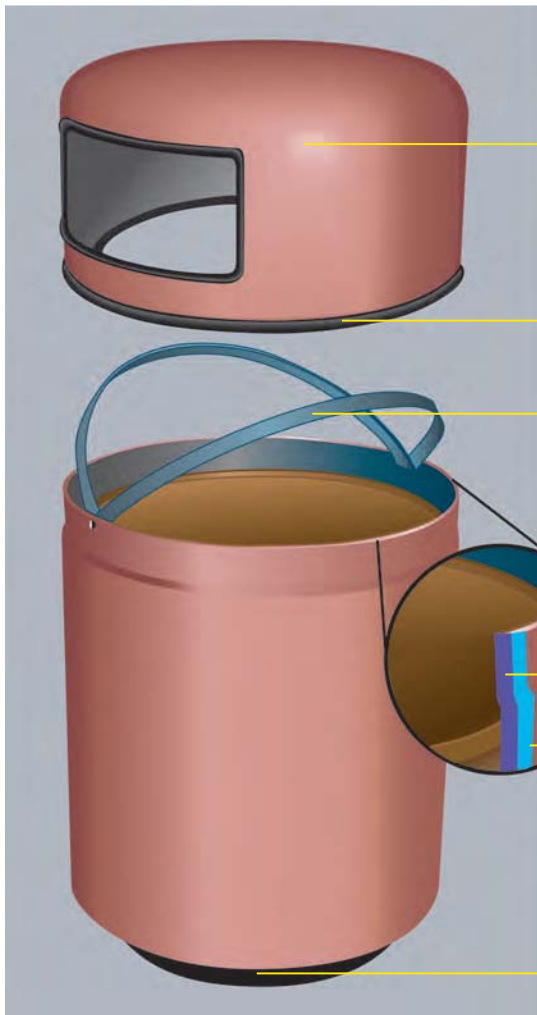

Standard Gel-Coat, Matte, Gran-x™, Sand-x™, and Fresco Fiberglass finishes are recommended for indoor and outdoor use. Dura-Tone™ finish is suitable for indoor use only.

Vinyl trim on edges and disposal openings prevents chipping and damage during maintenance.

Folding retainer bands hold can liners securely inside all two-piece receptacles.

Eliminate unsightly can liner exposure with our exclusive can liner retainer bands.

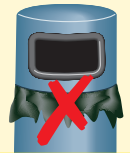

Seamless, molded construction with multiple thermosetting resin additives.

The Gel-Coat finish will not stain or tarnish and includes a UV stabilizer to resist fading.

Recessed base protects against accidental damage.

Fiberglass Container Custom Options

- Custom color matching and designs available
- All models with two openings are available with a single opening as a custom order
- FM-Approved Fire-Safe / Self-Extinguishing Receptacles w/ doors available as custom order
- Optional Fire Retardant treated and certified
 - 1.) Class I Fire Retardant Flame Spread 0-25
 - 2.) Class II Fire Retardant Flame Spread 26-75

Steel Container Custom Options

Custom Color Options

Architek® models are available in a variety of powder-coated color combinations to match your specific color scheme.

- Stadiums and arenas
- Corporate parks
- Shopping malls
- Sitescapes
- Recreational facilities
- Hotels

Laser-Cut Panels

Prominently display your logo with one or more custom panels.

Other Custom Options

- Vinyl decals



Custom Uni-Koat® Colors

Beautiful rich colors with exceptional resistance to corrosion, scratches, and stains.

- Available in 180 weather-resistant powder-coat colors
- Contact your Rubbermaid Commercial Products' Sales Representative to see a complete sampling of Uni-Koat® powder-coat colors
- For use in exterior and interior applications



The above is just a sample of what is available. With 180 customization options, accenting your facility is simple.

Colors shown are as accurate as the printing process allows.

Depending on the container model, the logo/graphics will be cut directly into the steel receptacle or steel panel, capturing incredible detail that will withstand any environment.



FG555ST
Custom color

FG555ET
Custom color

FGS3ET
Custom color

LASER-CUT GRAPHICS*

*Not available on Infinity Waste Containers.

These high-quality vinyl decals will capture any logo or graphic, no matter how detailed. The extremely durable UV-protected decals are laminated for indoor or outdoor use and can be cleaned with standard solvents. Logos and graphics are printed in full color with photographic quality, and can be die-cut into most shapes.



FG9W4400 /
FG9W5900

FG9W3800 /
FG9W5600

DECALS

Single-color logos and graphic lettering can be custom die-cut from a variety of stock colors with unique finishes and easily applied directly to the receptacle. Contact your Rubbermaid Commercial Products' Sales Representative for a full list of available colors and options.

DIE-CUT DECALS

Sharp-edged one or two color designs are printed directly onto any flat surface and will maintain their attractive appearance for years to come.



FGDRR24CSM

SILKSCREEN

High-quality print that is usually larger than a hot stamp and has multicolor (3) capability.

Custom Logos and Graphics

Add custom graphics to almost any of our products. Ideal for promoting sports teams, schools and universities, and other branding initiatives.

- Select from four methods to best suit your application
- No minimum quantity
- Turnaround is approximately 6–8 weeks

REQUIREMENTS FOR SUBMITTING GRAPHICS

PREFERRED FORMAT

- Vector files in Adobe Illustrator Version CS3 or earlier (convert all fonts to outlines)

ACCEPTED FORMATS

- EPS, JPEG, TIFF, or print-ready PDF with graphics at least 300 DPI and a minimum size of 15" x 15"
- Camera-ready, two-dimensional art suitable for scanning with a minimum size of 2" x 2"

WILL NOT ACCEPT

- Low-resolution files, i.e., files taken from the Internet

WHERE TO SEND FILES

- Please contact your Rubbermaid Commercial Products' Sales Representative for information or call 1-800-347-9800

PROOF

- A graphic representation of your artwork on the receptacle will be supplied for your approval



Panel options available for Aspen and Keystone Series™ containers.

Part	Color	Description	UPC	Page
401096		Auto Flush® High-Mount Adapter Kit		30
401165		Auto Flush® Crane Valve Adapter Kit		30
401239		Auto Flush® Teck Valve Adapter		30
401477		Auto Flush® Tempus Valve Adapter		30
401972		Auto Flush® Coyne & Delany/Crane Rex Adapter Kit		31
401973		Auto Flush® Canadian Adapter Kit (Crane, Teck, Tempus)		31
490071		One Shot® A/C Adapter		18
490071		One Shot® A/C Adapter		19
500394		One Shot® 800 mL Starter Kit (Chrome/Black Dispenser, Hand Wash Refill, 4 D Batteries)		19
500449		One Shot® 1600 mL Starter Kit (Chrome/Black Dispenser, Hand Wash Refill, 4 D Batteries)		19
500582		One Shot® Low-Profile 800 mL Starter Kit (Chrome Dispenser, Hand Wash Refill, 4 D Batteries)		19
500585		One Shot® Low-Profile 1600 mL Starter Kit (Chrome Dispenser, Hand Wash Refill, 4 D Batteries)		19
750242		Foam Soap Dispenser Key and Lock		24
750615		Foam Skin Care Dispenser Back Plate – White		24
750616		Foam Skin Care Dispenser Back Plate – Black		24
751060		Foam Soap 1000 mL Pouch Holder		24
1777155	CLR	Economy Pitcher		281
1777191	WHT	Cake Keeper	071691390015	262
1779636	BLUE	Lid for FG264300 and FG264860 Containers		129
1779699	BLUE	BRUTE® Container without Lid		127
1779700	BLUE	Lid for FG261000 BRUTE® Container		129
1779731	BLUE	Lid for FG262000 BRUTE® Container		129
1779732	BLUE	BRUTE® Container without Lid		127
1779733	BLUE	Lid for FG265500 BRUTE® Container		129
1779742	GRAY	Untouchable® Top for FG295600 Container		139
1780875		Enriched Lotion Multi-Duty Hand Cleaner with Scrubbers		26
1780877		Enriched Lotion Super-Duty Hand Cleaner with Scrubbers		26
1780885		ProRx™ Dispenser White – 2 L		26
1780886		ProRx™ Dispenser Black – 2 L		26
1780889		ProRx™ Washfountain Mounting Adapter – 2" dia		26
1780890		ProRx™ Washfountain Mounting Adapter – 4" dia		26
1780891		ProRx™ Bracket for 64-oz Bottle		26
1781466		Waxed Bag for FG13		38
1782742		Milano in Polished Chrome (Low Lead)		28
1782743		Milano in Polished Chrome (Low Lead)		28
1782744		Milano in Polished Chrome (Low Lead)		29
1784284		Rubbermaid HYGEN™ Microfiber Kit with Charging Bucket		54
1784285		Rubbermaid HYGEN™ Microfiber Kit with Rubbermaid PULSE™		54
1788372	BLUE	Slim Jim® Single Stream Recycling Top for Slim Jim® Containers		135
1788373	GREEN	Slim Jim® Single Stream Recycling Top for Slim Jim® Containers		135
1788374	BLUE	Untouchable® Single Stream Recycling Top for FG356900 Containers		136
1788375	GREEN	Untouchable® Single Stream Recycling Top for FG356900 Containers		136
1788376	BLUE	BRUTE® Bottle/Can Recycling Top for 2632 Containers		129
1788377	GREEN	BRUTE® Bottle/Can Recycling Top for 2632 Containers		129
1788378	BLUE	BRUTE® Paper Recycling Top for 2632 Containers		129
1788379	GREEN	BRUTE® Paper Recycling Top for 2632 Containers		129
1788380	BLUE	BRUTE® Single Stream Recycling Top for 2632 Containers		129
1788471	GREEN	BRUTE® Single Stream Recycling Top for 2632 Containers		129
1788472	GREEN	BRUTE® Recycling Container without Lid		127
1791678	GRAY	General-Purpose Microfiber Mop		46
1791679	GREEN/ BLUE	Microfiber Wet and Dust Mop Plus for PULSE™		46
1791680	BLUE	Microfiber Mop Plus		46
1791791	BLUE	Microfiber Wet and Scrub Mop Plus		46
1791792	GREEN	Microfiber Dust Mop with Fringe		46
1791793	GREEN	Microfiber Dust Mop	086876212433	46
1791794	BLUE	Rough-Surface Microfiber Mop		46
1791795	BLUE	Microfiber High-Absorbency Mop Plus		46
1791796	BLUE	Rough-Surface Scrub Microfiber Mop		46
1791797	YELLOW	Filter Bucket with Wringer Combo Yellow		45
1791798	BLACK	Filter Bucket Wringer		45
1791799	YELLOW	Filter Bucket		45
1791800	BLACK	Filter Replacement		45

Part	Color	Description	UPC	Page
1791801	RED/ YELLOW/ BLUE/ GREEN	Color-Coded Wringer Handle Grip Kit		45
1791802	YELLOW	Top-Down Charging Bucket		47
1792339	BLUE	Two-Stream Glutton® Recycling Station		149
1792340	GREEN	Two-Stream Glutton® Recycling Station		149
1792371	BEIGE	Two-Stream Glutton® Recycling Station		149
1792372	BLUE	Two-Stream Glutton® Recycling Station		149
1792373	GREEN	Two-Stream Glutton® Recycling Station		149
1792374	BEIGE	Two-Stream Glutton® Recycling Station		149
1792975		Recycle Label Kit		135, 136, 149
1792975		Recycle Label Kit		136
1792975		Recycle Label Kit		149
1793505		AutoJanitor® LED Dispenser – Black		36
1793506		AutoJanitor® LED Dispenser – White		36
1793507		AutoJanitor® LED Dispenser – Chrome		36
1793508		Pump LCD Dispenser – Black		17
1793509		Pump LCD Dispenser – White		17
1793510		Pump LCD Dispenser – Chrome		17
1793531		Microburst® 3000 LCD Dispenser – Black		10
1793532		Microburst® 3000 LCD Dispenser – White		10
1793533		Microburst® 3000 LCD Dispenser – Chrome		10
1793534		Microburst® 9000 LCD Dispenser – Black		10
1793535		Microburst® 9000 LCD Dispenser – White		10
1793536		Microburst® 9000 LCD Dispenser – Chrome		10
1793537		Standard Aerosol LED Dispenser – Black		12
1793538		Standard Aerosol LED Dispenser – White		12
1793539		Standard Aerosol LED Dispenser – Chrome		12
1793540		Standard Aerosol LCD Dispenser – Black		12
1793541		Standard Aerosol LCD Dispenser – White		12
1793542		Standard Aerosol LCD Dispenser – Chrome		12
1793543		TCell™ Fan Dispenser – Black		14
1793544		TCell™ Fan Dispenser – White		14
1793545		TCell™ Fan Dispenser – Chrome		14
1793546		TCell™ Dispenser – Black		14
1793547		TCell™ Dispenser – White		14
1793548		TCell™ Dispenser – Chrome		14
1799152		Lock 'N Go Kit		45
1800381		Auto Door™		37
1800382		Auto Door™ Sensor		37
1800383		Auto Door™ Sensor Extension Cable		37
1800384		Auto Door™ Electric Strike		37
1805727	RD00	Sanitizer-Safe Microfiber Cloth – Red		54
1805728	BL00	Sanitizer-Safe Microfiber Cloth – Blue		54
1805729	YLO0	Sanitizer-Safe Microfiber Cloth – Yellow		54
1805730	GR00	Sanitizer-Safe Microfiber Cloth – Green		54
1805988	BLA	Deluxe Housekeeping Cart with Locking Drawer	086876213515	105
1809375		Self-Wringing Twist Mop		77
1812588		Compact Digital Portion Control Scale (2 lb)	086876214130	265
1812589		Compact Digital Portion Control Scale (10 lb)	086876214147	265
1812590		High-Performance Digital Portion Control Scale (2 lb)	086876214154	264
1812591		High-Performance Digital Portion Control Scale (12 lb)	086876214161	264
1812592		High-Performance Digital Portion Control Scale (24 lb)	086876214178	264
1812593		Premium Stainless Steel Dishwasher-Safe Digital Portion Control Scale (6 lb)	086876214185	264
1812594		Premium Stainless Steel Dishwasher-Safe Digital Portion Control Scale (12 lb)	086876214192	264
1812595		Premium Stainless Steel Dishwasher-Safe Digital Portion Control Scale (12 lb)	086876214208	264
1812616		Stainless Steel Replacement Platform for Compact Scales	086876214215	265
1812617		Stainless Steel Replacement Platform for High-Performance Scales	086876214222	264
1812621		Foot/Hip Tare Switch	086876214253	265
1812622		Oversized Portion Platform – Stainless Steel	086876214260	265
1812623		AC Adapter	086876214277	265
1812624		Stainless Steel Replacement Platform for Premium Scales	086876214284	264
1812625		Pizza Scale Kit – oversize platform, display, tare switch	086876214291	264
1818966		Milano in Polished Chrome (Low Lead)		28
1818967		Milano in Polished Chrome (Low Lead)		28
1818968		Milano in Polished Chrome (Low Lead)		29
1820577	PINK	12" x 12" Microfiber Light Commercial Cloth		55
1820578	GREEN	12" x 12" Microfiber Light Commercial Cloth		55
1820579	BLUE	12" x 12" Microfiber Light Commercial Cloth		55
1820580	YELLOW	12" x 12" Microfiber Light Commercial Cloth		55
1820581	PINK	16" x 16" Microfiber Light Commercial Cloth		55
1820582	GREEN	16" x 16" Microfiber Light Commercial Cloth		55
1820583	BLUE	16" x 16" Microfiber Light Commercial Cloth		55
1820584	YELLOW	16" x 16" Microfiber Light Commercial Cloth		55
1821662		Locking Casters		45
1829397	GREEN	BRUTE® Dome Top for FG263200 Containers		129

¹ FedEx shippable items.

* Contact Customer Service for UPC information not provided.

Part	Color	Description	UPC	Page	Part	Color	Description	UPC	Page
1829398	BLUE	BRUTE® Dome Top for FG263200 Containers		129	1863886	GRAY	Executive Series™ Multipurpose Microfiber Flat Mop		46
1829399	YELLOW	BRUTE® Dome Top for FG263200 Containers		129	1863887	GRAY	Executive Series™ Multipurpose PULSE™ Wet and Dust Mop		46
1829400	GREEN	Slim Jim® Swing Lid for Slim Jim® Containers		135	1863888	GRAY	Executive Series™ Multipurpose 12" x 12" Microfiber Light Commercial Cloth		55
1829401	BLUE	Slim Jim® Wall Mounted Container		140	1863889	GRAY	Executive Series™ Multipurpose Microfiber Cloth (Gray)		53
1829402	RED	Slim Jim® Wall Mounted Container		140	1863890	BROWN	Executive Series™ Multipurpose 12" x 12" Microfiber Light Commercial Cloth		55
1829403	GREEN	Slim Jim® Wall Mounted Container		140	1863891	BROWN	Executive Series™ Multipurpose Microfiber Cloth (Brown)		53
1829404	YELLOW	Slim Jim® Wall Mounted Container		140	1863892	GRAY	Executive Series™ Charging Bucket		47
1829406	GREEN	Wastebasket, Large		139	1863893	BLACK	18" (45.7 cm) Executive Series™ Quick-Connect Wet/Dry Frame		50
1829407	GREEN	Untouchable® Top for FG295700 Container		139	1863894	BLACK	Executive Series™ Double-Sided Folding Frame		45
1829408	BLUE	Untouchable® Top for FG295700 Container		139	1863895	GRAY	18" (45.7 cm) Executive Series™ Microfiber Damp Room Mop		51
1829409	GRAY	Untouchable® Top for FG295700 Container		139	1863896	BLACK	Executive Series™ WaveBrake® Side Press Combo		60
1829410	WHITE	BRUTE® Rollout Container with Lid		133	1863897	GRAY	Executive Series™ WaveBrake® Side Press Combo		60
1829411	GREEN	BRUTE® Rollout Container with Lid		133	1863898	BLACK	Executive Series™ WaveBrake® Down Press Combo		60
1829412	GREEN	Wastebasket, Small		139	1863899	GRAY	Executive Series™ WaveBrake® Down Press Combo		60
1829413	GREEN	Step-On Container		141	1863900	GRAY	Executive Series™ Dirty Water Bucket for WaveBrake® Combos		63
1829414	BLUE	Step-On Container		141	1863901	BLACK	Executive Series™ Gripper® Clamp-Style Wet Mop Handle, Plastic Black Head, Bamboo Composite Handle		75
1829415	GRAY	Step-On Container		141	1863902	BLACK	Executive Series™ Invader® Side Gate Wet Mop Handle, Large Black Plastic Head, Bamboo Composite Handle		75
1829416	BLUE	Step-On Container		141	1863903	BLACK	Executive Series™ Invader® Side Gate Wet Mop Handle, Large Black Plastic Head, Fiberglass Handle		75
1829417	GREEN	Step-On Container		141	1867396	BLACK	11" Executive Series™ Microfiber Flexi-Frame Flat Mop		52
1834781	RED	Round Bucket – Sanitizer	086876216455	77	1867397	BLACK	18" (45.7 cm) Executive Series™ Microfiber Fringed Dust Mop		51
1835528	YELLOW	Rubbermaid Pulse™ Mopping Kit with Single-Sided Frame		49	1867398	GRAY	Executive Series™ Microfiber Glass/Mirror Cloth (Gray)		53
1835529	YELLOW	Rubbermaid Pulse™ Mopping Kit with Double-Sided Folding Frame		49	1867399	BLACK	6.5" Bristle Brush Roll (for FG421288)		119
1835530	BLUE	Slim Jim® with Venting Channels and UV-Inhibitors – Outdoor		134	1867400	BLACK	7.5" Bristle Brush Roll (for FG421388)		119
1835671	GREEN	Slim Jim® with Venting Channels and UV-Inhibitors – Outdoor		134	1867501	BLACK	7.5" Rubber Brush Roll (for FG421588)		119
1835672	GRAY	Slim Jim® with Venting Channels and UV-Inhibitors – Outdoor		134	1867502	BLACK	40" Handle, Threaded (for FG421288, FG421388, FG421588)		119
1836136		Standard Aerosol – Purifying Spa		12	1867503	BLACK	6.5" Dirt Tray (for FG421288)		119
1836137		Standard Aerosol – Relaxing Spa		12	1867504	BLACK	7.5" Dirt Tray (for FG421388 and FG421588)		119
1836138		Standard Aerosol – Energizing Spa		12	1867505	BLACK	Executive Series™ Floor Sign with Multilingual "Caution" Imprint, 2-Sided		242
1836139		Microburst® 3000 Refill – Purifying Spa		11	1867506	GRAY	Executive Series™ Floor Sign with Multilingual "Caution" Imprint, 2-Sided		242
1836140		Microburst® 3000 Refill – Relaxing Spa		11	1867507	GOLD	Executive Series™ Floor Sign with Multilingual "Caution" Imprint, 2-Sided		243
1836241		Microburst® 3000 Refill – Energizing Spa		11	1867508	SILVER	Executive Series™ Floor Sign with Multilingual "Caution" Imprint, 2-Sided		243
1836252		Microburst® 9000 Refill – Purifying Spa		11	1867509	BLACK	Executive Series™ Floor Sign with Multilingual "Caution" Imprint, 4-Sided		242
1836253		Microburst® 9000 Refill – Relaxing Spa		11	1867510	GRAY	Executive Series™ Floor Sign with Multilingual "Caution" Imprint, 4-Sided		242
1836254		Microburst® 9000 Refill – Energizing Spa		11	1867533	BLACK	Executive Series™ BRUTE® Caddy Bag for FG263200, FG264300 Containers		131
1836255		Microburst® Duet Purifying/Relaxing Spa		9	1867535	BLACK	Executive Series™ Utility Cart w/ 5" Quiet Casters		223
1836256		TCell™ Refill – Purifying Spa		15	1868433	BLACK	6-Qt Capacity Executive Series™ Backpack Vacuum Cleaner		110
1836257		TCell™ Refill – Relaxing Spa		15	1868434	BLACK	10-Qt Capacity Executive Series™ Backpack Vacuum Cleaner		110
1836258		TCell™ Refill – Energizing Spa		15	1868435	BLACK	10-Qt Capacity Executive Series™ HEPA Backpack Vacuum Cleaner		110
1837785		Refuse Cover for 618900, 619000, 619100, 619200, 9T1900 Carts		107	1868436	BLACK	12" Executive Series™ Traditional Upright Vacuum Cleaner		113
1840999	ORAN	Insulated Beverage Dispenser		281	1868437	BLACK	16" Executive Series™ Traditional Upright Vacuum Cleaner		113
1851454	BLACK	High-Capacity Vinyl Replacement Bag		95, 102, 108	1868438	BLA	12" Executive Series™ Power-Height Upright Vacuum Cleaner		112
1855312	BLACK	Double-Sided Folding Frame		45	1868439	BLA	15" Executive Series™ Power-Height Upright Vacuum Cleaner		112
1857374	YELLOW	5-Quart Disinfecting Pail – Yellow		102	1868440	BLA	12" Executive Series™ Manual-Height Upright Vacuum Cleaner		112
1857375	RED	5-Quart Disinfecting Pail – Red		102	1868621	BLA	15" Executive Series™ Manual-Height Upright Vacuum Cleaner		112
1857376	BLUE	5-Quart Disinfecting Pail – Blue		102	1868622	BLACK	12" Ultra-Light Upright Vacuum Cleaner		113
1857377	GREEN	5-Quart Disinfecting Pail – Green		102	1868623	YEL	Replacement Power Cord for FG9VBP06, FG9VBP10, FG9VBH10		111
1857378	BLACK	5-Quart Disinfecting Pail – Black		102	1868697	BLUE	18" (45.7 cm) Microfiber Damp Mop		55
1857379	WHITE	5-Quart Disinfecting Pail – White		102	1868698	GREEN	18" (45.7 cm) Microfiber Fringed Dust Mop		55
1857380	GRAY	5-Quart Disinfecting Pail – Gray		102	1868991	BLA	Trash Cover		103
1861076	BLACK	Executive Series™ Broom, 1 1/8" dia (4.92 cm) Vinyl-Coated Metal Handle, Flagged Polypropylene Fill		87					
1861078	BLA	Executive Series™ Broom, 1" dia (2.5 cm) Metal Handle, Flagged Polypropylene Fill		87					
1861211	GRAY	Executive Series™ Plastic Foam Block, Medium Floor Sweep, Polypropylene Fill		88					
1861212	BLACK	Executive Series™ Plastic Foam Block, Heavy-Duty Floor Sweep, Coarse Polypropylene and Polystyrene Fill		88					
1861213	LIGHT GRAY	Executive Series™ Plastic Foam Block, Fine Floor Sweep, Flagged Polypropylene Fill		87					
1861427	BLACK	Executive Series™ Janitorial Cleaning Cart, High-Security		95, 98					
1861428	BLACK	Executive Series™ Janitorial Cleaning Cart w/ Bins, High-Capacity		95, 98					
1861429	BLACK	Executive Series™ Janitorial Cleaning Cart, High-Capacity		95, 99					
1861430	BLACK	Executive Series™ Janitorial Cleaning Cart, Standard		99					
1861441	BLACK	Executive Series™ Janitorial Cleaning and Recycling Cart, High-Capacity		95, 99					
1861442	BLACK	Vinyl Replacement Bag with Zipper for 1861430 Cleaning Cart		99					
1861443	BLACK	Executive Series™ Locking Cabinet Doors		99					
1863882	SILVER	48"-72" (121.9 cm-182.9 cm) Executive Series™ Rubbermaid HYGEN™ Series Microfiber Telescoping Handle		49					
1863883	SILVER	20"-40" (50.8 cm-101.6 cm) Executive Series™ Rubbermaid HYGEN™ Series Microfiber Telescoping Handle		49					
1863884	SILVER	Rubbermaid PULSE™ Executive Series™ Mopping Kit with Single-Sided Frame		49					
1863885	SILVER	Rubbermaid PULSE™ Executive Series™ Mopping Kit with Double-Sided Folding Frame		49					

¹ FedEx shippable items.

* Contact Customer Service for UPC information not provided.

Part	Color	Description	UPC	Page
1871788	GRAY	Replacement Power Cord for 1868433, 1868434, 1868435		111
1871789		Replacement 2-Piece Wand Assembly for Backpack Vacuum		113
1871791		Replacement Tool Connection Adapter for Backpack Vacuum		113
1871792		Replacement 12" Crevice Tool for Backpack Vacuum		113
1871793		Replacement 5" Upholstery Tool for Backpack Vacuum		113
1871881		Replacement HEPA Intake Filter for Backpack Vacuum		113
1871894		Replacement 3" Brush Assembly for Backpack Vacuum		113
1871895		Hard Floor Nozzle for Backpack Vacuum		113
1874723	RD/BL/ YL/GR	Sanitizer-Safe Microfiber Cloth – 4-Pack		54
3485847		Purinel® SC Refill – Clear		34
3485848		Purinel® SC Refill – Blue		34
3485949		Microburst® Duet Gentle Breeze/Linen Fresh		9
3485950		Microburst® Duet Alpine Spring/Mountain Peaks		9
3485951		Microburst® Duet Ocean Breeze/Sea Mist		9
3485952		Microburst® Duet Cotton Berry/Refreshing Citrus		9
3485982	SM	1-Stream Waste/Recycling Station, Nonlocking		155
3485983	SM	1-Stream Waste/Recycling Station, Locking		155
3485984	SM	1-Stream Waste/Recycling Station, Nonlocking		155
3485985	DP	1-Stream Waste/Recycling Station, Nonlocking		155
3485986	DP	1-Stream Waste/Recycling Station, Locking		155
3485987	DP	1-Stream Waste/Recycling Station, Nonlocking		155
3485988	SM	2-Stream Paper/Trash, Nonlocking		155
3485989	SM	2-Stream Paper/Trash, Locking		155
3485990	SM	2-Stream Paper/Trash, Nonlocking		155
3485991	SM	2-Stream Trash/Cans and Bottles, Nonlocking		155
3485992	SM	2-Stream Trash/Cans and Bottles, Locking		155
3485993	SM	2-Stream Trash/Cans and Bottles, Nonlocking		155
3485994	SM	2-Stream Paper/Cans and Bottles, Nonlocking		155
3485995	SM	2-Stream Paper/Cans and Bottles, Locking		155
3485996	SM	2-Stream Paper/Cans and Bottles, Nonlocking		155
3485997	DP	2-Stream Paper/Trash, Nonlocking		155
3485998	DP	2-Stream Paper/Trash, Locking		155
3485999	DP	2-Stream Paper/Trash, Nonlocking		155
3486000	DP	2-Stream Trash/Cans and Bottles, Nonlocking		155
3486001	DP	2-Stream Trash/Cans and Bottles, Locking		155
3486002	DP	2-Stream Trash/Cans and Bottles, Nonlocking		155
3486003	DP	2-Stream Paper/Cans and Bottles, Nonlocking		155
3486004	DP	2-Stream Paper/Cans and Bottles, Locking		155
3486005	DP	2-Stream Paper/Cans and Bottles, Nonlocking		155
3486006	SM	3-Stream Paper/Trash/Cans and Bottles, Nonlocking		155
3486007	SM	3-Stream Paper/Trash/Cans and Bottles, Locking		155
3486008	SM	3-Stream Paper/Trash/Cans and Bottles, Nonlocking		155
3486009	DP	3-Stream Paper/Trash/Cans and Bottles, Nonlocking		155
3486010	DP	3-Stream Paper/Trash/Cans and Bottles, Locking		155
3486011	DP	3-Stream Paper/Trash/Cans and Bottles, Nonlocking		155
3486012	SM	4-Stream Paper/Bottles/Trash/Cans, Nonlocking		155
3486013	SM	4-Stream Paper/Bottles/Trash/Cans, Locking		155
3486014	SM	4-Stream Paper/Bottles/Trash/Cans, Nonlocking		155
3486015	DP	4-Stream Paper/Bottles/Trash/Cans, Nonlocking		155
3486016	DP	4-Stream Paper/Bottles/Trash/Cans, Locking		155
3486017	DP	4-Stream Paper/Bottles/Trash/Cans, Nonlocking		155
3486037	SM	1-Stream Waste/Recycling Station, Nonlocking		155
3486038	SM	2-Stream Paper/Trash, Nonlocking		155
3486039	SM	2-Stream Trash/Cans and Bottles, Nonlocking		155
3486040	SM	2-Stream Paper/Cans and Bottles, Nonlocking		155
3486041	SM	3-Stream Paper/Trash/Cans and Bottles, Nonlocking		155
3486042	SM	4-Stream Paper/Bottles/Trash/Cans, Nonlocking		155
3486043	DP	1-Stream Waste/Recycling Station, Nonlocking		155
3486044	DP	2-Stream Paper/Cans and Bottles, Nonlocking		155
3486045	DP	2-Stream Paper/Trash, Nonlocking		155
3486046	DP	2-Stream Paper/Cans and Bottles, Nonlocking		155
3486047	DP	3-Stream Paper/Trash/Cans and Bottles, Nonlocking		155
3486048	DP	4-Stream Paper/Bottles/Trash/Cans, Locking		155
3486092		Microburst® Duet Variety Pack (1 of ea. refill)		9
3486108		Professional Spray Mop (mop not included)		55
3486110		15-oz Replacement Refill Cartridge		55
3486552		SaniCell™ Pipe and AutoFlush™ Sidemount (Toilet)		33
3486553		SaniCell™ Pipe and AutoFlush™ Sidemount (Urinal)		33
3486554		SaniCell™ Pipe and AutoFlush™ Clamp (Toilet)		33
3486555		SaniCell™ Pipe and AutoFlush™ Clamp (Urinal)		33
3486561		Enriched Foam Hand Wash		23
3486562		Enriched Lotion Hand Wash		23
3486571		Enriched Foam Hand Wash		23

Part	Color	Description	UPC	Page
3486572		Enriched Lotion Hand Wash		23
3486573		Enriched Foam Antibacterial Hand Wash – E2		23
3486574		Enriched Lotion Antibacterial Hand Wash – E2		23
3486575		Enriched Foam Hand and Body Shampoo		23
3486576		Enriched Lotion Hand and Body Shampoo		23
3486577		Enriched Foam Alcohol-Free Hand Sanitizer – E3		23
3486579		Enriched Foam Alcohol-Plus Hand Sanitizer – E3		23
3486582		Enriched Foam Alcohol Plus Hand Sanitizer – E3		23
3486586		Enriched Foam Alcohol Plus Hand Sanitizer – E3		23
3486589		Rubbermaid Flex™ Dispenser White – 500 mL		22
3486590		Rubbermaid Flex™ Dispenser Black – 500 mL		22
3486591		Rubbermaid Flex™ Dispenser White 1000 mL, 1300 mL		22
3486592		Rubbermaid Flex™ Dispenser Black 1000 mL, 1300 mL		22
3486593		Rubbermaid Flex™ Manual Dispenser Drip Tray – Grey		22
3486594		Rubbermaid Flex™ Manual Dispenser Lock Plate – Grey		22
3486595		Rubbermaid Flex™ Manual Dispenser Lock Plate Key		22
3486596		Rubbermaid Flex™ Wall Bracket for 18-oz Bottle		22
3486597		Rubbermaid Flex™ Manual Dispenser Screw Packet		22
4870476		SaniCell™ Pipe with 3/4" Connector – Chrome		33
4870479		SaniCell™ Pipe with 1 1/4" and 1 1/2" Connectors – Chrome		33
4870485		SaniCell™ Wall Service – White/White		34
4870486		SaniCell™ Wall Service – White/Gray		34
4870487		SaniCell™ Wall Service – Black/Black		34
4870488		SaniCell™ Wall Service – Black/Chrome		34
4870489		SaniCell™ Wall LED – White/White		34
4870490		SaniCell™ Wall LED – White/Gray		34
4870491		SaniCell™ Wall LED – Black/Black		34
4870492		SaniCell™ Wall LED – Black/Chrome		34
4870504		3/4" Connection Kit		34
4870505		1 1/4" Connection Kit		34
4870506		1 1/2" Connection Kit		34
4870509		12 1/2" Stainless Steel Tube		34
4870510		24" x 8" Stainless Steel Tube		34
4870511		Hand Drill Kit		34
4870577		Auto Flush® Power Adapter Kit		31
20564020		Wheel for FG564000		239
20566300		Wheel for FG566361		238
22564210		Wheel for FG564210		238, 239
50564205		Axle for FG564000		239
50565400		Axle for FG565461		238
50566200		Axle for FG566261		238
50566300		Axle for FG566361		238
51566000		Axle for FG566000, FG566061		238
52564200		Axle for FG564200, FG564261		238
53565800		Axle for FG565861		239
70565900		Axle for FG565961		239
4012902T		Drip Delivery Kit		34
401290ZT		Drip Delivery Kit		36
7E6000	KIWI	Economy Pitcher		281
7E60RD	CHILI	Economy Pitcher		281
7H75TR	CHILI	Premier Small-Capacity Storage w/ Lid	071691394037	257
7H76TR	CHILI	Premier Small-Capacity Storage w/ Lid	071691394044	257
7H77TR	CHILI	Premier Small-Capacity Storage w/ Lid	071691394051	257
7H78TR	CHILI	Premier Small-Capacity Storage w/ Lid	071691394066	257
7H79TR	CHILI	Premier Small-Capacity Storage w/ Lid	071691394013	257
925658C1	BLA	Axle Retainer for FG565861		239
925659C1	BLA	Axle Retainer for FG565961		239
FG007710000000		Digital Hanging Scale	077177408216	267
FG007750000000		Digital Hanging Scale	077177408223	267
FG007800000000		Dial Hanging Scale	077177060032	267
FG007810000000		Hanging Scale	077177891025	267
FG007820000000		Hanging Scale	077177892022	267
FG007826000000		Hanging Scale	077177408230	267
FG007830000000		Hanging Scale	077177893029	267
FG007842000000		Dial Hanging Scale with Tare	077177084229	267
FG007895000000		Compact Hanging Scale	077177089521	267
FG007908000000		Galvanized Steel Scoop	077177000809	267
FG10	WHT	Sanitary Napkin Wall-Mount with Drop Bottom		38
FG1000E	BK	Steel Receptacle Urn	097591014905	167
FG10100		Heavy-Duty Receiving Scale	077177070556	268
FG10100S		Heavy-Duty Receiving Scale	077177070563	268
FG101100	BLA	Structural Foam Tilt Truck, Utility-Duty	086876184181	231
FG101300	BLA	Structural Foam Tilt Truck, Standard-Duty	086876184198	231
FG10200		Heavy-Duty Receiving Scale	077177070600	268
FG10200S		Heavy-Duty Receiving Scale	077177070655	268
FG102500	BLA	Tilt Truck, Standard-Duty (RM)	086876183764	232
FG102542	BLA	Forkliftable Tilt Truck, Standard-Duty (RM)	086876179651	233
FG102600	BLA	Tilt Truck, Heavy-Duty (RM)	086876183771	232
FG102641	BLA	Towable Trainable Tilt Truck, Heavy-Duty (RM)	086876183870	233
FG102700	BLA	Lid for 1 1/2" Cubic Yard Tilt Trucks	086876183849	232, 233

¹ FedEx shippable items. ² Requires 3 weeks lead time

* Contact Customer Service for UPC information not provided.

Part	Color	Description	UPC	Page
FG102700	BLA	Lid for 1 1/2 Cubic Yard Hoppers	086876183849	233
FG102800	BLA	Domed Lid for 3/4 Cubic Yard Tilt Trucks	086876184235	231
FG103500	BLA	Tilt Truck, Standard-Duty (RM)	086876183788	232
FG103600	BLA	Tilt Truck, Heavy-Duty (RM)	086876183788	232
FG104500	BLA	Tilt Truck, Standard-Duty (RM)	086876183801	232
FG104600	BLA	Tilt Truck, Heavy-Duty (RM)	086876183818	232
FG105400	BLA	Self-Dumping Hopper	086876183887	234
FG105443	BLA	Self-Dumping Hopper with four 6" dia (15.2 cm) Polyolefin Casters	086876179705	234
FG105900	BLA	Self-Dumping Hopper	086876183900	234
FG105943	BLA	Self-Dumping Hopper with four 6" dia (15.2 cm) Polyolefin Casters	086876183917	234
FG1060		Heavy-Duty Receiving Scale	077177070518	268
FG106400	BLA	Self-Dumping Hopper	086876183924	234
FG106443	BLA	Self-Dumping Hopper with four 6" dia (15.2 cm) Polyolefin Casters	086876183931	234
FG106900	BLA	Self-Dumping Hopper	086876183948	234
FG106943	BLA	Self-Dumping Hopper with four 6" dia (15.2 cm) Polyolefin Casters	086876183955	234
FG107400	BLA	Self-Dumping Hopper	086876183962	234
FG107443	BLA	Self-Dumping Hopper with four 6" dia (15.2 cm) Polyolefin Casters	086876183979	234
FG108100		Heavy-Duty Receiving Scale – Dual-Read	077177077050	268
FG108200		Heavy-Duty Receiving Scale – Dual-Read	077177077074	268
FG10860		Heavy-Duty Receiving Scale – Dual-Read	077177077036	268
FG11	SSSTL	Sanitary Napkin Wall-Mount with Drop Bottom includes (3) FG614100 Waxed Bags		38
FG1100	BK	Steel Receptacle Ash/Trash		163
FG1100	SBS	Ash/Trash		164
FG1100	SSS	Ash/Trash		164
FG1100	SSS	Steel Receptacle Ash/Trash		202
FG1100E	BK	Steel Receptacle Ash/Trash	097591016107	167, 202
FG11720438	BLA	ActionPacker® Storage Container	086876166446	237
FG11910138	BLA	ActionPacker® Cargo Box	086876166446	237
FG11920138	BLA	ActionPacker® Cargo Box		237
FG13	WHT	Double Stall Sanitary Napkin with Foot Pedals includes (3) 1781466 Waxed Bags		38
FG130400	BLA	Tilt Truck, Utility-Duty (RM)	086876183702	232
FG130500	YEL	Tilt Truck, Standard-Duty (RM)	086876157253	232
FG130500	RED	Tilt Truck, Standard-Duty (RM)	086876157239	232
FG130500	DBLUE	Tilt Truck, Standard-Duty (RM)	086876157215	232
FG130500	BLA	Tilt Truck, Standard-Duty (RM)	086876183702	232
FG130542	BLA	Forkliftable Tilt Truck, Standard-Duty (RM)	086876179637	233
FG130573	BLUE	Recycling Tilt Truck, Standard-Duty (RM)	086876194302	232
FG130600	BLA	Tilt Truck, Heavy-Duty (RM)	086876183726	232
FG130641	BLA	Towable Trainable Tilt Truck, Heavy-Duty (RM)	086876183856	233
FG130700	BLA	Lid for 1/2 Cubic Yard Tilt Trucks	086876183825	232, 233
FG130700	BLA	Lid for FG130641	086876183825	233
FG130700	BLA	Lid for 1/2 Cubic Yard Hoppers	086876183825	234
FG131400	BLA	Tilt Truck, Utility-Duty (RM)	086876183733	232
FG131500	YEL	Tilt Truck, Standard-Duty (RM)	086876200614	232
FG131500	RED	Tilt Truck, Standard-Duty (RM)	086876157260	232
FG131500	DBLUE	Tilt Truck, Standard-Duty (RM)	086876157246	232
FG131500	BLA	Tilt Truck, Standard-Duty (RM)	086876183740	232
FG131542	BLA	Forkliftable Tilt Truck, Standard-Duty (RM)	086876179644	233
FG131600	BLA	Tilt Truck, Heavy-Duty (RM)	086876183757	232
FG131641	BLA	Towable Trainable Tilt Truck, Heavy-Duty (RM)	086876183863	233
FG131700	BLA	Lid for 1-Cubic-Yard Tilt Trucks	086876183832	232, 233
FG131700	BLA	Lid for FG131641	086876183832	233
FG131700	BLA	Lid for 1-Cubic-Yard Hoppers	086876183832	234
FG135	WHT	Single Stall Sanitary Napkin with Foot Pedals includes (3) 6141 Waxed Bags		38
FG16100111	ORAN	Insulated Beverage Dispenser	079154116240	281
FG16830111	ORAN	Insulated Beverage Dispenser	079154116189	281
FG172000	GRAY	Palletote® Lid for FG172100, FG172200	086876001075	236, 279
FG172100	GRAY	Palletote® Box	086876001136	236, 279
FG172200	GRAY	Palletote® Box	086876001235	236, 279
FG173000	GRAY	Palletote® Lid for FG173100, FG173200	086876001280	236, 279
FG173100	GRAY	Palletote® Box	086876001334	236, 279
FG173200	GRAY	Palletote® Box	086876001402	236, 279
FG1855	BK, EGN, RD	Steel Drum Dome Top for use w/ FGH55, FGH55C, FGH55E, FGMT32, FGSBR52		150
FG190100	0000	Scraper	086876155464	260
FG190500	0000	Scraper	086876155525	260
FG190600	0000	Scraper	086876155518	260
FG191300	0000	Scraper-Icing Blade		260
FG193300	WHT	Spoon-Shaped Spatula	086876162226	260
FG193400	WHT	Spoon-Shaped Spatula	086876162233	260
FG193800	WHT	Spoon-Shaped Spatula	086876162240	260
FG196200	0000	High-Heat Scraper	086876148992	260
FG196300	0000	High-Heat Scraper	086876149005	260
FG196400	0000	High-Heat Scraper	086876149012	260
FG196600	RED	High-Heat Spoon Scraper	086876159684	260
FG196700	RED	High-Heat Spoon Scraper	086876159691	260
FG196800	RED	High-Heat Spoon Scraper	086876159707	260
FG199200	GRAY	Closet Organizer/Tool Holder Kit	086876127881	120
FG199300	GRAY	Closet Organizer/Tool Holder Kit	086876127898	120
FG199400	YEL	Value Kit (2 S-Hooks/1 Double Hook)	086876127904	120
FG200500	CHAR	Heavy-Duty Dust Pan	086876116960	90

Part	Color	Description	UPC	Page
FG200GL	WH	Wall-Mounted Litter Receptacle		140
FG2030	BK	Steel Drum Dome Top for use w/ FGH12, FGMT22		150
FG2030	BR	Steel Drum Dome Top for use w/ FGH12, FGMT22		150
FG2030	EGN	Steel Drum Dome Top for use w/ FGH12, FGMT22		150
FG218800	WHT	Ironing Organizer	086876167016	120
FG245506	WHT	Ironing Organizer	086876147704	120
FG252300	BLA	Mobile Two-Step Stepstool	086876009323	121
FG252300	BEIG	Mobile Two-Step Stepstool	086876031645	121
FG253100	BLA	Executive Series™ Lobby Pro® Upright Dust Pan	086876156164	94
FG253200	BLA	Executive Series™ Lobby Pro® Upright Dust Pan with Cover	086876156171	94
FG253300	BLA	Lobby Pro® Deluxe Upright Dust Pan with Cover and Adjustable Handle Grip	086876156188	94
FG253400	BLA	Lobby Pro® Upright Dust Pan Adjustable Handle Grip	086876156195	94
FG253500	BLA	Lobby Pro® Upright Dust Pan Hanger Bracket	086876156201	94
FG253600	BLA	Executive Series™ Lobby Broom, Synthetic Fill	086876156232	94
FG254000	BEIG	Fire-Resistant Wastebasket	086876117158	140
FG254100	GRAY	Fire-Resistant Wastebasket	086876117172	140
FG254100	BLA	Fire-Resistant Wastebasket	086876117165	140
FG254100	BEIG	Fire-Resistant Wastebasket	086876117196	140
FG254300	GRAY	Fire-Resistant Wastebasket	086876117240	140
FG254300	BLA	Fire-Resistant Wastebasket	086876117233	140
FG254300	BEIG	Fire-Resistant Wastebasket	086876117264	140
FG254400	BEIG	Fire-Resistant Wastebasket	086876117295	140
FG256800	OWHT	Glutton® Container	086876011043	193
FG256800	BRN	Glutton® Container	086876011029	193
FG256806	DGRN	Glutton® Container	086876194142	148
FG256873	BLUE	Glutton® Recycling Container	086876194142	148
FG256K00	GRAY	Rigid Liner for Glutton® Container	086876011197	193
FG256L00	DGRN	Glutton® Bottle and Can Recycling Top for 256B Containers	086876194418	148
FG256L00	DBLUE	Glutton® Bottle and Can Recycling Top for 256B Containers	086876159882	148
FG256V00	RED	Glutton® Hooded Top without doors for 256B Containers	086876011272	193
FG256V00	BRN	Glutton® Hooded Top without doors for 256B Containers	086876011241	193
FG256W00	BLA	Hold-Down Base for 256B Containers	086876011296	193
FG256X00	RED	Glutton® Hooded Top with doors for 256B Containers	086876011333	193
FG256X00	BRN	Glutton® Hooded Top with doors for 256B Containers	086876011302	193
FG257088	BRN	GroundsKeeper® Smoking Management Receptacle	086876166866	200
FG257088	BLA	GroundsKeeper® Smoking Management Receptacle	086876166873	200
FG257088	BEIG	GroundsKeeper® Smoking Management Receptacle	086876166859	200
FG258100	BLA	Classic Smoking Urn Insert Tray, Round for 2582 Base	086876011722	201
FG258200	BLA	Classic Smoking Urn Base, Floor Model	086876011739	201
FG258500	BLA	Classic Smoking Urn with Metal Ashtray Top	086876011845	201
FG258600	BLA	Classic Smoking Urn, Ash/Trash w/ Metal Ashtray Top and Metal Liner	086876011944	201
FG258800	CHRM	Classic Metal Ashtray Top, Round for 2585, 2586 Bases	086876012002	201
FG260900	YEL	Lid for FG261000 BRUTE® Container	086876203028	129
FG260900	WHT	Lid for FG261000 BRUTE® Container	086876012415	129
FG260900	RED	Lid for FG261000 BRUTE® Container	086876203011	129
FG260900	GRAY	Lid for FG261000 BRUTE® Container	086876012385	129
FG260900	DGRN	Lid for FG261000 BRUTE® Container	086876203035	129
FG261000	YEL	BRUTE® Container without Lid	086876012477	127
FG261000	WHT	BRUTE® Container without Lid	086876012491	127, 252
FG261000	RED	BRUTE® Container without Lid	086876202984	127
FG261000	GRAY	BRUTE® Container without Lid	086876202991	127
FG261000	DGRN	BRUTE® Container without Lid	086876203004	127
FG261400	GRAY	Round Bucket	086876012903	77
FG261400	RED	Round Bucket	086876012910	77
FG261700	GRAY	Double Pail	086876194098	77
FG261960	YEL	Lid for FG262000 BRUTE® Container	086876191714	129
FG261960	WHT	Lid for FG262000 BRUTE® Container	086876191738	129
FG261960	RED	Lid for FG262000 BRUTE® Container	086876191745	129
FG261960	GRAY	Lid for FG262000 BRUTE® Container	086876191752	129
FG261960	BLA	Lid for FG262000 BRUTE® Container	086876203066	129
FG261960	DGRN	Lid for FG262000 BRUTE® Container	086876203073	129
FG262000	GRAY	BRUTE® Container without Lid	086876013436	127
FG262000	WHT	BRUTE® Container without Lid	086876013450	127, 252
FG262000	YEL	BRUTE® Container without Lid	086876013474	127
FG262000	BLUE	BRUTE® Container without Lid	086876047462	127
FG262000	RED	BRUTE® Container without Lid	086876203042	127
FG262000	DGRN	BRUTE® Container without Lid	086876203056	127
FG262073	BLUE	BRUTE® Recycling Container without Lid	086876194265	127
FG262400	WHT	GreensKeeper® Container, with Lid and Dolly	086876013979	262
FG262888	GRAY	Double Pail	086876026382	77
FG263100	RED	Lid for FG263200 BRUTE® Containers	086876014013	129
FG263100	YEL	Lid for FG263200 BRUTE® Containers	086876014051	129

¹ FedEx shippable items.

* Contact Customer Service for UPC information not provided.

Part	Color	Description	UPC	Page
FG263100	GRAY	Lid for FG263200 BRUTE® Containers	086876014655	129
FG263100	WHT	Lid for FG263200 BRUTE® Containers	086876014662	129
FG263100	DGRN	Lid for FG263200 BRUTE® Containers	086876179040	129
FG263100	BLUE	Lid for FG263200 BRUTE® Containers	086876192018	129
FG263200	RED	BRUTE® Container without Lid	086876014112	103, 127
FG263200	WHT	BRUTE® Container without Lid	086876014136	103, 127, 252
FG263200	YEL	BRUTE® Container without Lid	086876014150	103, 127
FG263200	GRAY	BRUTE® Container without Lid	086876014679	103, 127
FG263200	BLUE	BRUTE® Container without Lid	086876047493	103, 127
FG263200	DGRN	BRUTE® Container without Lid	086876179026	103, 127
FG263246	YEL	BRUTE® Container without Lid with "USDA Condemned" Black Imprint, English and Spanish	086876144116	127
FG263256	GRAY	BRUTE® Container without Lid with "inedible" Black Imprint, English and Spanish	086876130515	127
FG263273	BLUE	BRUTE® Recycling Container without Lid	086876194272	127
FG263600	WHT	GreensKeeper® Container, with Lid and Dolly	086876015386	262
FG263788	GRAY	BRUTE® Dome Top for FG263200 Containers	086876148695	129
FG263788	RED	BRUTE® Dome Top for FG263200 Containers	086876148701	129
FG264000	BLA	BRUTE® Dolly for FG262000, FG263200, FG264300, FG265500 Containers	086876015492	130
FG264000	BLA	BRUTE® Dolly for FG9G7400, FG9G7500, FG262000, and FG263200	086876015492	252
FG264043	BLA	BRUTE® Quiet Dolly for FG262000, FG263200, FG264300, FG265500 Containers		130
FG264200	YEL	BRUTE® Caddy Bag for FG263200, FG264300 Containers	086876015621	131
FG264300	GRAY	BRUTE® Container without Lid	086876014631	127
FG264300	RED	BRUTE® Container without Lid	086876015645	127
FG264300	WHT	BRUTE® Container without Lid	086876015669	127
FG264300	YEL	BRUTE® Container without Lid	086876015683	127
FG264300	BLUE	BRUTE® Container without Lid	086876047516	127
FG264300	DGRN	BRUTE® Container without Lid	086876179033	127
FG264307	BLUE	BRUTE® Recycling Container with Venting Channels	086876191691	127, 128
FG264346	YEL	BRUTE® Container without Lid with "USDA Condemned" Black Imprint, English and Spanish	086876144123	127
FG264356	GRAY	BRUTE® Container without Lid with "inedible" Black Imprint, English and Spanish	086876144130	127
FG264360	GRAY	BRUTE® 44-Gallon Utility Container with Venting Channels	086876183556	103, 111, 117
FG264360	BLA	BRUTE® 44-Gallon Utility Container with Venting Channels	086876183566	103, 111, 117
FG264360	YEL	BRUTE® 44-Gallon Utility Container with Venting Channels	086876183573	103, 111, 117
FG264360	BLUE	BRUTE® 44-Gallon Utility Container with Venting Channels	086876183580	103, 111, 117
FG264360	RED	BRUTE® 44-Gallon Utility Container with Venting Channels	086876191684	103, 111, 117
FG264360	GRAY	BRUTE® 44-Gallon Utility Container with Venting Channels	086876183556	128
FG264360	BLA	BRUTE® 44-Gallon Utility Container with Venting Channels	086876183566	128
FG264360	YEL	BRUTE® 44-Gallon Utility Container with Venting Channels	086876183573	128
FG264360	BLUE	BRUTE® 44-Gallon Utility Container with Venting Channels	086876183580	128
FG264360	RED	BRUTE® 44-Gallon Utility Container with Venting Channels	086876191684	128
FG264373	BLUE	BRUTE® Recycling Container without Lid	086876194289	127
FG264560	WHT	Lid for FG264300 and FG264860 Containers		129
FG264560	GRAY	Lid for FG264300 and FG264860 Containers	086876042658	129
FG264560	BLA	Lid for FG264300 and FG264860 Containers	086876183566	129
FG264560	RED	Lid for FG264300 and FG264860 Containers	086876187489	129
FG264560	YEL	Lid for FG264300 and FG264860 Containers		129
FG264560	DGRN	Lid for FG264300 and FG264860 Containers		129
FG264600	BLA	BRUTE® Tandem Dolly for FG262000, FG263200, FG264300, FG265500, FG352600, FG353600 Containers	086876161779	130
FG264788	GRAY	BRUTE® Dome Top for FG264300 Containers	086876148718	129
FG264788	RED	BRUTE® Dome Top for FG264300 Containers	086876148725	129
FG264900	GRAY	Maid Caddy	086876016482	131
FG265000	BLA	Universal Drum Dolly for FG265500 Container	086876016499	130
FG265100	BLA	BRUTE® Trainable Dolly – 1-Pack	086876180251	130
FG265103	BLA	BRUTE® Trainable Dolly – 3-Pack	086876180268	130
FG265200	BLA	BRUTE® Trainable Dolly Pull Handle	086876180275	130
FG265400	GRAY	Lid for FG265500 BRUTE® Container	086876016505	129
FG265400	DGRN	Lid for FG265500 BRUTE® Container	086876203127	129
FG265400	WHT	Lid for FG265500 BRUTE® Container	086876203134	129
FG265400	RED	Lid for FG265500 BRUTE® Container	086876203141	129
FG265400	YEL	Lid for FG265500 BRUTE® Container	086876203158	129
FG265500	GRAY	BRUTE® Container without Lid	086876005318	127
FG265500	DGRN	BRUTE® Container without Lid	086876203080	127
FG265500	WHT	BRUTE® Container without Lid	086876203097	127

Part	Color	Description	UPC	Page
FG265500	RED	BRUTE® Container without Lid	086876203103	127
FG265500	YEL	BRUTE® Container without Lid	086876203110	127
FG265788	GRAY	BRUTE® Dome Top for FG265500 Container	086876148732	129
FG265788	RED	BRUTE® Dome Top for FG265500 Container	086876148749	129
FG266400	BEIG	Untouchable® Square Swing Top for FG395800, FG395900 Containers	086876016819	137
FG266400	GRAY	Untouchable® Square Swing Top for FG395800, FG395900 Containers	086876057621	137
FG267200	BEIG	Untouchable® Round Swing Top for FG294700, FG354600 Containers	086876016987	137
FG267200	GRAY	Untouchable® Round Swing Top for FG294700, FG354600 Containers	086876017014	137
FG267360	BLA	Slim Jim® Swing Lid for Slim Jim® Containers	086876186406	135
FG267360	GRAY	Slim Jim® Swing Lid for Slim Jim® Containers	086876187533	135
FG267360	BEIG	Slim Jim® Swing Lid for Slim Jim® Containers		135
FG267400	BLA	Slim Jim® Hinge Lid for Slim Jim® Containers	086876186413	135
FG268888	LGRAY	Slim Jim® Handle Top for Slim Jim® Containers	086876147599	135
FG268888	BRN	Slim Jim® Handle Top for Slim Jim® Containers		135
FG268888	YEL	Slim Jim® Handle Top for Slim Jim® Containers		135
FG268988	BLA	Untouchable® Swing Top for FG356907, FG356988 Containers	086876191486	137
FG268988	BEIG	Untouchable® Swing Top for FG356907, FG356988 Containers	086876192544	137
FG268988	GRAY	Untouchable® Swing Top for FG356907, FG356988 Containers		137
FG269000	BLUE	Untouchable® Paper Recycling Top for FG356900 Containers	086876191493	136
FG269000	GRN	Untouchable® Paper Recycling Top for FG356900 Containers		136
FG269100	BLUE	Untouchable® Bottle and Can Recycling Top for FG356900 Containers	086876191509	136
FG269100	GRN	Untouchable® Bottle and Can Recycling Top for FG356900 Containers		136
FG269288	BRN	Slim Jim® Bottle and Can Recycling Top for Slim Jim® Containers	086876147612	135
FG269288	GRN	Slim Jim® Bottle and Can Recycling Top for Slim Jim® Containers	086876147629	135
FG269288	BLUE	Slim Jim® Bottle and Can Recycling Top for Slim Jim® Containers	086876188431	135
FG270388	BLUE	Slim Jim® Paper Recycling Top for Slim Jim® Containers	086876147636	135
FG270388	GRN	Slim Jim® Paper Recycling Top for Slim Jim® Containers	086876191813	135
FG279100	DBLUE	Untouchable® Bottle and Can Recycling Top for FG395806, FG395906 Containers	086876156546	136
FG279400	DBLUE	Untouchable® Paper Recycling Top for FG395806, FG395906 Containers	086876156553	136
FG288200	CLR	Bouncer® Bar Scoop	086876017854	261
FG288400	CLR	Bouncer® Utility Scoop	086876017878	261
FG288500	WHT	Utility Scoop	086876017915	261
FG288600	CLR	Bouncer® Utility Scoop	086876017939	261
FG289000	BLA	Condiment Dispenser with Six 1 U.S. pt (0.5 L) Inserts	086876120547	280
FG289100	BLA	Condiment Dispenser with Three 1 U.S. qt (0.9 L) Inserts	086876120554	280
FG294700	GRAY	Untouchable® Round Container	086876018288	137
FG295073	BLA	Side Bin Recycling Center (fits FG295600 and FG295700)	086876200584	139
FG295073	GRAY	Side Bin Recycling Center (fits FG295600 and FG295700)	086876200591	139
FG295073	BLUE	Side Bin Recycling Center (fits FG295600 and FG295700)	086876200607	139
FG295073	GRN	Side Bin Recycling Center (fits FG295600 and FG295700)		139
FG295200	BEIG	Wastebasket, Vanity	086876018349	139
FG295500	GRAY	Wastebasket, Small	086876018523	139
FG295500	BEIG	Wastebasket, Small	086876026030	139
FG295500	BLA	Wastebasket, Small	086876026061	139
FG295573	BLUE	Deskside Recycling Container, Small with Universal Recycle Symbol	086876194166	139
FG295600	BEIG	Wastebasket, Medium	086876012538	139
FG295600	BLA	Wastebasket, Medium	086876018837	139
FG295600	GRAY	Wastebasket, Medium	086876018851	139
FG295606	GRN	Deskside Recycling Container, Medium with Universal Recycle Symbol	086876191806	139
FG295673	BLUE	Deskside Recycling Container, Medium with Universal Recycle Symbol	086876194173	139
FG295700	BEIG	Wastebasket, Large	086876019162	139
FG295700	BLA	Wastebasket, Large	086876019179	139
FG295700	GRAY	Wastebasket, Large	086876019193	139
FG295773	BLUE	Deskside Recycling Container, Large with Universal Recycle Symbol	086876194180	139
FG296300	RED	Round Bucket	086876019353	77
FG296300	GRAY	Round Bucket		77
FG3062PR	PERI	Economy Pitcher	071691012061	281
FG3063RD	WHT	Economy Pitcher		281
FG306409	WHT	Mixing Pitcher		281
FG306600	BLA	Untouchable® Top for FG295600 Container	086876147728	139
FG306600	BEIG	Untouchable® Top for FG295600 Container	086876147735	139
FG306700	BLA	Untouchable® Top for FG295700 Container	086876147742	139

¹ FedEx shippable items.

* Contact Customer Service for UPC information not provided.

Part	Color	Description	UPC	Page
FG306700	BEIG	Untouchable® Top for FG295700 Container	086876147759	139
FG307120	BEIG	Untouchable® Top/Soft Wastebasket Combo: FG306700 Lid/FG295700 Wastebasket	086876149340	139
FG315488	BLA	Deluxe Carry Caddy	086876193695	121
FG321000	CLR	Bouncer® Measuring Cup	086876019650	261
FG321500	CLR	Bouncer® Measuring Cup	086876019667	261
FG321600	CLR	Bouncer® Measuring Cup	086876019681	261
FG321700	CLR	Bouncer® Measuring Cup	086876019704	261
FG321800	CLR	Bouncer® Measuring Cup	086876019728	261
FG330000	CLR	Food/Tote Box	086876019766	255
FG330100	CLR	Food/Tote Box	086876019780	255
FG330200	CLR	Lid for FG330000, FG330100, FG330600, FG330800, FG332800 Food/Tote Boxes	086876019803	255
FG330300	CLR	Colander for Tote Boxes 6" deep or greater	086876019841	254
FG330400	CLR	Food/Tote Box	086876019865	255
FG330500	CLR	Proserve® Dual-Action Lid	254	
FG330600	CLR	Food/Tote Box	086876019889	255
FG330700	CLR	Food/Tote Box	086876019902	255
FG330800	CLR	Food/Tote Box	086876019926	255
FG330900	CLR	Food/Tote Box	086876019957	255
FG331000	CLR	Lid for FG330400, FG330700, FG330900 Food/Tote Boxes	086876019971	255
FG331100	CLR	Proserve® Dual-Action Lid	254	
FG331400	CLR	Drain Tray	254	
FG331500A	OWHT	ProServe™ Prep Cart with Cutting Board (8-slot end loader for full-size insert pans)	086876149128	275
FG331500A	BLA	ProServe™ Prep Cart with Cutting Board (8-slot end loader for full-size insert pans)	086876155419	275
FG331600A	OWHT	ProServe™ Prep Cart with Cutting Board (8-slot side loader for food boxes and sheet pans)	086876149142	275
FG331600A	BLA	ProServe™ Prep Cart with Cutting Board (8-slot side loader for food boxes and sheet pans)	086876155426	275
FG331700	OWHT	ProServe™ Rack (18-slot end loader for full-size insert pans)	086876149166	275
FG331700	BLA	ProServe™ Rack (18-slot end loader for full-size insert pans)	086876155433	275
FG331800	CLR	Drain Tray	254	
FG331900	OWHT	ProServe™ Rack (18-slot side loader for food boxes and sheet pans)	086876149180	275
FG332000	OWHT	ProServe™ Rack (18-slot side loader for food boxes and sheet pans)	086876155372	275
FG332000	BLA	ProServe™ Rack (18-slot side loader for food boxes and sheet pans)	086876155389	275
FG332400	OWHT	ProServe™ Rack (18-slot dual loader for full-size insert pans)	086876155396	275
FG332400	BLA	ProServe™ Rack (18-slot dual loader for full-size insert pans)	086876155402	275
FG332800	CLR	Food/Tote Box	086876020205	255
FG333100	CLR	Bouncer® II Pitcher	086876020274	281
FG333400	CLR	Bouncer® II Pitcher	086876020335	281
FG333500	CLR	Bouncer® Pitcher	086876020342	281
FG333600	CLR	Bouncer® Pitcher	086876020366	281
FG333700	CLR	Bouncer® Pitcher	086876020380	281
FG333800	GOLD	Bouncer® Pitcher	086876020427	281
FG333800	CLR	Bouncer® Pitcher	086876024234	281
FG333900	CLR	Bouncer® Pitcher	086876020472	281
FG334900	GRAY	Bus/Utility Box	086876021011	225, 277, 280
FG334900	WHT	Bus/Utility Box	086876129694	225, 277, 280
FG334992	GRAY	Bus/Utility Box, Bulk Pack	086876021097	280
FG334992	WHT	Bus/Utility Box, Bulk Pack	086876155303	280
FG335000	BRN	Divided Bus/Utility Box	086876021103	280
FG335100	BRN	Undivided Bus/Utility Box	086876021141	280
FG335100	GRAY	Undivided Bus/Utility Box	086876021165	280
FG335192	BRN	Undivided Bus/Utility Box, Bulk Pack	086876140989	280
FG335192	GRAY	Undivided Bus/Utility Box, Bulk Pack	086876140996	280
FG335388	BLA	Refuse Bin	086876162844	107, 225, 277
FG335488	BLA	Utility Bin	086876162851	107, 225, 277
FG335488	BLA	Utility Bin	086876162851	225
FG335488	BLA	Utility Bin	086876162851	277
FG335588	PLAT	Utility Cart with Enclosed End Panels	086876173154	226
FG335800	AMBER	Beverage Dispenser	086876021646	281
FG335800	CLR	Beverage Dispenser	281	
FG335900	CLR	Beverage Dispenser	086876021684	281
FG336200	GRAY	Cutlery Bin, 4 Compartments	086876042979	280
FG342100	PLAT	Utility Cart with 3" dia (7.6 cm) Swivel Casters and End Panels	086876159523	226
FG342100	BLA	Utility Cart with 3" dia (7.6 cm) Swivel Casters and End Panels	086876159530	226
FG342488	PLAT	Utility Cart with 4" dia (10.2 cm) Swivel Casters	086876159493	226
FG342488	BLA	Utility Cart with 4" dia (10.2 cm) Swivel Casters	086876159509	226
FG342488	OWHT	Utility Cart with 4" dia (10.2 cm) Swivel Casters	086876159516	226

Part	Color	Description	UPC	Page
FG342488	RED	Utility Cart with 4" dia (10.2 cm) Swivel Casters	086876164718	226
FG342488	PLAT	Utility Cart with 4" dia (10.2 cm) Swivel Casters	086876159493	227
FG342488	BLA	Utility Cart with 4" dia (10.2 cm) Swivel Casters	086876159509	227
FG342488	OWHT	Utility Cart with 4" dia (10.2 cm) Swivel Casters	086876159516	277
FG342488	RED	Utility Cart with 4" dia (10.2 cm) Swivel Casters	086876164718	277
FG343700	BLA	Utility Cart with Lockable Doors, Sliding Drawer, and 4" dia (10.2 cm) Swivel Casters	086876163087	226
FG350000	WHT	Food/Tote Box	086876022650	255
FG350100	WHT	Food/Tote Box	086876022711	255
FG350200	WHT	Lid for FG350000, FG350100, FG350600, FG350800, FG352800 Food/Tote Boxes	086876022759	255
FG350400	WHT	Food/Tote Box	086876022780	255
FG350600	WHT	Food/Tote Box	086876022827	255
FG350700	WHT	Food/Tote Box	086876022858	255
FG350800	WHT	Food/Tote Box	086876022896	255
FG350900	WHT	Food/Tote Box	086876022971	255
FG351000	WHT	Lid for FG350400, FG350700, FG350900 Food/Tote Boxes	086876023046	255
FG351700	RED	Combo Pack includes FG352600 Square BRUTE® Container, FG352900 Snap-Lock® Lid	086876156065	132
FG352000	BEIG	Untouchable® Half Round Container	086876194234	137
FG352000	GRAY	Untouchable® Half Round Container	086876194234	137
FG352073	BLUE	Half-Round Recycling Container	086876194234	134
FG352600	GRAY	BRUTE® Square Container without Lid	086876044294	132
FG352600	WHT	BRUTE® Square Container without Lid	086876044300	132
FG352600	RED	BRUTE® Square Container without Lid	086876147773	132
FG352700	GRAY	Lid for FG352600 Container	086876044324	132
FG352700	WHT	Lid for FG352600 Container	086876044331	132
FG352700	RED	Lid for FG352600 Container	086876147780	132
FG352800	WHT	Food/Tote Box	086876023220	255
FG352900	RED	Snap-Lock® Lid for FG352600 Container	086876156041	132
FG353000	BLA	BRUTE® Square Dolly for FG352600, FG353600 Containers	086876044355	130, 244, 245
FG353600	GRAY	BRUTE® Square Container without Lid	086876044362	132
FG353600	WHT	BRUTE® Square Container without Lid	086876044379	132
FG353673	BLUE	BRUTE® Square Recycling Container without Lid	086876194296	127, 132
FG353900	GRAY	Lid for FG353600 Container	086876044393	132
FG353900	WHT	Lid for FG353600 Container	086876044409	132
FG354000	BRN	Slim Jim® Waste Container	086876023343	134
FG354000	GRAY	Slim Jim® Waste Container	086876023350	134
FG354000	BEIG	Slim Jim® Waste Container	086876044393	134
FG354000	BLUE	Slim Jim® Waste Container	086876047561	134
FG354000	BLA	Slim Jim® Waste Container	086876164855	134
FG354000	YEL	Slim Jim® Waste Container	086876180725	134
FG354007	BLUE	Slim Jim® with Venting Channels – Recycling	086876186383	103, 134
FG354007	GRN	Slim Jim® with Venting Channels – Recycling	086876186390	103, 134
FG354060	BLA	Slim Jim® with Venting Channels	086876186352	103, 134
FG354060	BEIG	Slim Jim® with Venting Channels	086876186369	103, 134
FG354060	GRAY	Slim Jim® with Venting Channels	086876186376	103, 134
FG354075	BLUE	Slim Jim® Recycling Container	086876194197	134
FG354100	BEIG	Slim Jim® Waste Container with Handles	086876141580	134
FG354100	LGRAY	Slim Jim® Waste Container with Handles	086876141597	134
FG354100	DBLUE	Slim Jim® Waste Container with Handles	086876194227	134
FG354173	BLUE	Slim Jim® Recycling Container with Handles	086876194227	134
FG354220	0000	Slim Jim® Combo: FG354100 (1) Light Gray, FG268888 (1) Light Gray	086876149357	135
FG354300	GRAY	Funnel Top for FG263200 Containers	086876023428	129
FG354600	BEIG	Untouchable® Round Container	086876023459	137
FG354600	GRAY	Untouchable® Round Container	086876023480	137
FG354800	GRAY	Untouchable® Round Funnel Top for FG294700, FG354600 Containers	086876023527	137
FG355000	GRAY	Rigid Liner for FG816088 Containers	086876023534	165
FG355000	GRAY	Rigid Liner for FG818488, FG818588 Containers	086876023534	202
FG355188	BLA	Slim Jim® Trolley for FG354000, FG354100 Containers	086876165128	135, 147
FG355200	GRAY	Rigid Liner with Rim for FG817088 Containers	086876023541	165
FG355200	GRAY	Rigid Liner with Rim for FG818088, FG818288 Containers	086876023541	202
FG355300	SSSTL	Slim Jim® Stainless Steel Dolly for Slim Jim® Containers	086876186420	135, 147
FG356300	BEIG	Rigid Liner for FG9P9000 and FG9P9100 Containers	086876192568	193
FG356600	GRAY	Rigid Liner for FG843088	086876023657	192
FG356907	GRN	Untouchable® Square Recycling Container	136	
FG356973	BLUE	Untouchable® Square Recycling Container	136	
FG356988	GRAY	Untouchable® Square Container	086876191424	137
FG356988	BEIG	Untouchable® Square Container	086876191431	137
FG356988	BRN	Untouchable® Square Container	086876191455	137
FG356988	BLA	Untouchable® Square Container	137	
FG360088	WHT	Slant-Front Ingredient Bin with Sliding Lid and 32-oz (0.9-L) Scoop	086876178142	250
FG360100	WHT	Flat-Top Ingredient Bin with Sliding Hinged Lid	086876023978	250
FG360288	WHT	Slant-Front Ingredient Bin with Sliding Lid and 32-oz (0.9-L) Scoop	086876178159	250
FG360388	WHT	Slant-Front Ingredient Bin with Sliding Lid and 32-oz (0.9-L) Scoop	086876178166	250
FG361600	WHT	Lid for FG369000 Food/Tote Box	086876024081	280
FG362000	BLA	Untouchable® Half-Round Lid, with Swing Door, for FG352000, FG352073 Containers	086876144352	137

¹ FedEx shippable items.

* Contact Customer Service for UPC information not provided.

Part	Color	Description	UPC	Page
FG364800	GRAY	Lid for FG334900 Bus/Utility Box	086876042658	280
FG369000	WHT	Food/Tote Box	086876025538	280
FG370612	714	4.5 Cu. Ft. Roughneck Lawn Cart Pallet, Green	075608370619	239
FG370712	907	3.25 Cu. Ft. Roughneck Lawn Cart Pallet, Platinum	075608370718	239
FG395800	BEIG	Untouchable® Square Container (liner for 9171/9173/3965)	086876026528	137
FG395800	GRAY	Untouchable® Square Container (liner for 9171/9173/3965)	086876057553	137
FG395800	BEIG	Untouchable® Square Container (liner for FG917188/FG917388)	086876026528	192
FG395800	GRAY	Untouchable® Square Container (liner for FG917188/FG917388)	086876057553	192
FG395800	BEIG	Untouchable® Square Container (Liner for FG396500)	086876026528	193
FG395800	GRAY	Untouchable® Square Container (Liner for FG396500)	086876057553	193
FG395873	BLUE	Square Recycling Container	086876194241	136
FG395900	BEIG	Untouchable® Square Container (liner for FG917500/FG917600)	086876026573	137, 192
FG395900	GRAY	Untouchable® Square Container (liner for FG917500/FG917600)	086876057560	137, 192
FG395973	BLUE	Square Recycling Container		136
FG396300	BEIG	Plaza® Container with Tray Top	086876156096	193
FG396300	BLA	Plaza® Container with Tray Top	086876156409	193
FG396400	DGRN	Plaza® Container	086876148008	193
FG396400	BLA	Plaza® Container	086876156447	193
FG396400	BEIG	Plaza® Container		193
FG396500	BEIG	Plaza® Container with Ashtray	086876148015	193
FG396500	BLA	Plaza® Container with Ashtray	086876156461	193
FG396500	DGRN	Plaza® Container with Ashtray		193
FG396600	DWOOD	Landmark Series® Classic Container, Ash/Trash Frame with 3569 Rigid Liner	086876039344	188
FG396600	SBLE	Landmark Series® Classic Container, Ash/Trash Frame with 3569 Rigid Liner	086876039351	188
FG396700	SBLE	Landmark Series® Classic Container, Funnel Top Frame with 3569 Rigid Liner	086876039375	188
FG396800	DGRN	Plaza® Bottle and Can Recycling Container		148
FG396873	BLUE	Plaza® Bottle and Can Recycling Container	086876194357	148
FG396900	DGRN	Plaza® Paper Recycling Container		148
FG396973	BLUE	Plaza® Paper Recycling Container	086876194364	148
FG397000	DWOOD	Landmark Series® Classic Container, Dome Top Frame with 3958 Rigid Liner	086876012989	188
FG397000	SBLE	Landmark Series® Classic Container, Dome Top Frame with 3958 Rigid Liner	086876013108	188
FG397000	BLA	Landmark Series® Classic Container, Dome Top Frame with 3958 Rigid Liner	086876172874	188
FG397001	SBLE	Landmark Series® Classic Container, Dome Top with Ashtray, Frame and 3958 Rigid Liner	086876099010	188
FG397001	DWOOD	Landmark Series® Classic Container, Dome Top with Ashtray, Frame and 3958 Rigid Liner	086876099027	188
FG397001	BLA	Landmark Series® Classic Container, Dome Top with Ashtray, Frame and 3958 Rigid Liner	086876172881	188
FG397088	BLA	Landmark Series® Classic Container, Dome Top Frame with Lock Option, with 3958 Rigid Liner	086876172898	188
FG397100	DWOOD	Landmark Series® Classic Container, Ash/Trash Frame with 3958 Rigid Liner	086876013351	188
FG397100	SBLE	Landmark Series® Classic Container, Ash/Trash Frame with 3958 Rigid Liner	086876013382	188
FG397200	SBLE	Landmark Series® Classic Container, Funnel Top Frame with 3958 Rigid Liner	086876029345	188
FG397500	DWOOD	Landmark Series® Classic Container, Dome Top Frame with 3959 Rigid Liner	086876013467	188, 195
FG397500	SBLE	Landmark Series® Classic Container, Dome Top Frame with 3959 Rigid Liner	086876013535	188, 195
FG397500	BLA	Landmark Series® Classic Container, Dome Top Frame with 3959 Rigid Liner	086876172904	188, 195
FG397501	SBLE	Landmark Series® Classic Container, Dome Top with Ashtray, Frame and 3959 Rigid Liner	086876099034	188, 195
FG397501	DWOOD	Landmark Series® Classic Container, Dome Top with Ashtray, Frame and 3959 Rigid Liner	086876099041	188, 195
FG397501	BLA	Landmark Series® Classic Container, Dome Top with Ashtray, Frame and 3959 Rigid Liner	086876172911	188, 195
FG397589	BLA	Landmark Series® Security Container with Lock and Clear Panels	086876173932	195
FG400055		AutoJanitor® BioFlush® Drain Maintenance Refill		36
FG400200	ROCK	Aggregate Panel for FG396600, FG396700 Landmark Series® Classic Container	086876039436	188
FG400200	CORL	Aggregate Panel for FG396600, FG396700 Landmark Series® Classic Container	086876039443	188
FG400230A1		Gel – Mandarin Orange		17
FG400250A1		Gel – Delicious Apple		17
FG400260A1		Gel – Cinnamon Spice		17
FG400262A1		Gel – Country Delight™		17
FG400300	ROCK	Aggregate Panel for FG397000, FG397001, FG397088, FG397100, FG397200 Landmark Series® Classic Containers	086876013597	188
FG400300	BSTON	Aggregate Panel for FG397000, FG397001, FG397088, FG397100, FG397200 Landmark Series® Classic Containers	086876013924	188

Part	Color	Description	UPC	Page
FG400300	CORL	Aggregate Panel for FG397000, FG397001, FG397088, FG397100, FG397200 Landmark Series® Classic Containers		188
FG400400	ROCK	Aggregate Panel for FG397500, FG397501 Landmark Series® Classic Container	086876013955	188
FG400400	BSTON	Aggregate Panel for FG397500, FG397501 Landmark Series® Classic Container	086876014006	188
FG400400	CORL	Aggregate Panel for FG397500, FG397501 Landmark Series® Classic Container		188
FG400500	CLR	Panels with Backing for Advertising for FG397500, FG397501 Containers	086876173147	188, 195
FG400573		Standard Aerosol – Vanilla Royale		12
FG400586		Purinel® – Drain Maintainer and Cleaner		35
FG400600	CLR	Clear Replacement Panel for FG397000, FG397001, FG397088, FG397100, FG397200 Containers	086876173840	195
FG400695		Pump LED Dispenser – White		17
FG400696		Standard Aerosol – Cinnamon Spice		12
FG400700	CLR	Clear Replacement Panel for FG397500, FG397501, FG397589 Containers	086876173925	195
FG400868		Standard Aerosol Service LED Dispenser – White		12
FG400978		AutoJanitor® Cleaner and Deodorizer Refill – Linen Fresh		36
FG400980		AutoJanitor® Cleaner and Deodorizer Refill – Mandarin Orange		36
FG400982		AutoJanitor® Cleaner and Deodorizer Refill – Country Delight		36
FG4009831		Standard Aerosol – Linen Fresh™		12
FG4009841		Standard Aerosol – Orchard Fields		12
FG4009851		Standard Aerosol – Mountain Peaks		12
FG400992A		Pump – Linen Fresh™		17
FG401088		Digital Receiving Scale	077117405280	268
FG401186A		Auto Flush® Sidemount Polished Chrome Urinal		30
FG401187A		Auto Flush® Sidemount Polished Chrome Toilet		30
FG401192		Pump – Pure		17
FG401206A		Auto Flush® Sidemount Polished Chrome Toilet		30
FG401207A		Auto Flush® Sidemount Polished Chrome Urinal		30
FG401220		Gel Economy Dispenser		17
FG4012211		Gel – Linen Fresh™		17
FG4012241		Gel – Ocean Breeze		17
FG401231		Standard Aerosol – Preference Pack		12
FG4012441		Microburst® 9000 Refill – Linen Fresh™		11
FG4012451		Microburst® 9000 Refill – Orchard Fields		11
FG4012461		Microburst® 9000 Refill – Mountain Peaks		11
FG4012471		Microburst® 9000 Refill – Ocean Breeze		11
FG4012481		Microburst® 9000 Refill – Country Delight™		11
FG4012491		Microburst® 9000 Refill – Preference Pack		11
FG4012551		Microburst® 3000 Refill – Linen Fresh™		11
FG4012561		Microburst® 3000 Refill – Orchard Fields		11
FG4012571		Microburst® 3000 Refill – Mountain Peaks		11
FG4012581		Microburst® 3000 Refill – Ocean Breeze		11
FG4012591		Microburst® 3000 Refill – Country Delight™		11
FG401260A		Microburst® 3000 Refill – Preference Pack		11
FG401265		Pump – Vita Splash™		17
FG401266		Pump – Mountain Spa™		17
FG401268		Pump – Tropix		17
FG401269		Pump – Vanilla		17
FG401273		Pump – Preference Pack		17
FG4012791		Gel – Cherry Berry		17
FG401310		One Shot® Liquid Dispenser – Polished Chrome/Black		19
FG4013111		Enriched Lotion Hand Soap with Moisturizers		19
FG4013121		Enriched Lotion Antibacterial Hand Wash		19
FG4013131		Green Certified Lotion Soap		19
FG401375		Microburst® 9000 Economizer Dispenser – White		10
FG401375		Standard Aerosol Economizer – White		12
FG401442		Microburst® 3000 Economizer Dispenser – White		10
FG401503		Standard Aerosol – Delicious Apple		12
FG401504		Standard Aerosol – Mandarin Orange		12
FG4015061		Standard Aerosol – Country Delight™		12
FG401528		One Shot® Liquid Dispenser – Brushed Chrome/Black		19
FG401532		AutoClean® Cleaner and Deodorizer Refill – Mandarin Orange		35
FG401533		AutoClean® Cleaner and Deodorizer Refill – Vita Splash		35
FG4015411		Enriched Lotion Hand Soap with Moisturizers		19
FG4015421		Enriched Lotion Antibacterial Hand Wash		19
FG4015431		Green Certified Lotion Soap		19
FG4015441		Manual Liquid Dispenser – Polished Chrome		19
FG4015471		Standard Aerosol – Ocean Breeze		12
FG401591		AutoClean® Cleaner and Deodorizer Refill – Linen Fresh		35
FG401689		Microburst® 3000 Refill – Cinnamon Spice		11
FG401690		Microburst® 3000 Refill – Mango		11
FG401691		Microburst® 3000 Refill – Vanilla Royale		11
FG401692		Microburst® 9000 Refill – Cinnamon Spice		11

* Contact Customer Service for UPC information not provided.

Part	Color	Description	UPC	Page
FG401693		Microburst® 9000 Refill – Mango		11
FG401694		Microburst® 9000 Refill – Vanilla Royale		11
FG401695		Standard Aerosol – Mango		12
FG401804A		Auto Flush® Clamp Polished Chrome Urinal		31
FG401805A		Auto Flush® Clamp Polished Chrome Toilet		31
FG401818		Milano in Polished Chrome		28
FG401824		Milano in Polished Brass		28
FG401832		One Shot® Liquid Dispenser Metal Spout – Polished Chrome/Black		19
FG401902A		Pump – Santa Fe		17
FG401904A		Pump – Ocean Breeze		17
FG401906A		Pump – Country Delight™		17
FG401909		Standard Aerosol – Lemon		12
FG401979		Auto Flush® Sloan Gem Adapter Kit		31
FG401980		Auto Flush® Toto Adapter Kit		31
FG401981		Auto Flush® Sidemount Polished Chrome Toilet – Metal		30
FG401982		Auto Flush® Sidemount Polished Chrome Urinal – Metal		30
FG402000	BLA	WeatherGard® Series Container with 20 U.S. gal (75.7 L) BRUTE® Container Rigid Liner	086876162523	179
FG402059A		Auto Flush® Clamp Polished Chrome Toilet – Metal		31
FG402060A		Auto Flush® Clamp Polished Chrome Urinal – Metal		31
FG402073		One Shot® Liquid Dispenser – Polished Chrome		19
FG402093		Microburst® 9000 Refill – Mandarin Orange		11
FG402100	BLA	WeatherGard® Series Container with 32 U.S. gal (121.1 L) BRUTE® Container Rigid Liner	086876162530	179
FG402110		TCell™ Refill – Wakening Spring		15
FG402111		TCell™ Refill – Polar Mist		15
FG402112		TCell™ Refill – Blue Splash		15
FG402113		TCell™ Refill – Citrus		15
FG402187		TCell™ Refill – Crystal Breeze		15
FG402236		TCell™ Refill Preference Pack		15
FG402241		One Shot® Liquid Dispenser Low-Profile – Polished Chrome		19
FG402243		One Shot® Liquid Dispenser Low-Profile Metal – Polished Chrome		19
FG402310		Clean Seat Foam 400 ml Dispenser – White		36
FG402312		Clean Seat Foaming Refill		36
FG402338		Sanitary Bin 5 Gallon – White		38
FG402339		Sanitary Bin 5-Gallon Liners – 15 per roll		38
FG402348		SaniSense Bin Deodorizer™		38
FG402354		Microburst® 9000 Refill – Blue Splash		11
FG402355		Microburst® 3000 Refill – Blue Splash		11
FG402356		Standard Aerosol – Blue Splash		12
FG402363		Enriched Lotion Free 'N' Clean Soap		19
FG402364		Enriched Lotion Free 'N' Clean Soap		19
FG402369		TCell™ Refill – Mango Blossom		15
FG402408		Microburst® 3000 Refill – Mandarin Orange		11
FG402413		Sanitary Bin 5 Gallon – Gray		38
FG402430		TCell™ Heavy-Duty Dispenser		14
FG402470		TCell™ Refill – Cucumber Melon		15
FG402472		TCell™ Refill – Tropical Sunrise		15
FG402473		TCell™ Refill – Summer Sorbet		15
FG402498		TCell™ Refill – Pure™ Odor Neutralizer		15
FG402537		Clean Seat Spray Refill		36
FG404088		Digital Receiving Scale	077177405310	26
FG409100	OWHT	Utility Cart, Open-Sided	086876133424	227
FG409100	GRAY	Utility Cart, Open-Sided	086876145076	227
FG409100	BLA	Utility Cart, Open-Sided	086876148947	227
FG409100	GRAY	Utility Cart, Open-Sided	086876145076	278
FG409100	BLA	Utility Cart, Open-Sided	086876148947	278
FG409100	OWHT	Utility Cart, Open-Sided	086876133424	278
FG409200	OWHT	Utility Cart with Enclosed End Panels on 2 Sides	086876133431	227
FG409300	OWHT	Utility Cart with Enclosed End Panels on 3 Sides	086876133448	227, 278
FG409300	BLA	Utility Cart with Enclosed End Panels on 3 Sides	086876153729	227, 278
FG409400	GRAY	Instrument Cart with Lockable Doors and Sliding Drawers	086876145069	227
FG409500	BLA	Equipment Cart	086876153750	227
FG409600	BLA	4-Shelf Cart, Open-Sided	086876153736	227
FG420903	CYLN	Two-Step Folding Stepstool	071691223917	120
FG421288	BLA	Floor and Carpet Sweeper	086876187373	118, 119
FG421388	BLA	Dual-Action Sweeper	086876187380	118, 119
FG421588	BLA	Brushless Mechanical Sweeper	086876187397	118, 119
FG424288	BLA	100 U.S. Gal Stock Tank	086876190465	237
FG424300	BLA	50 U.S. Gal Stock Tank	086876006308	237
FG424400	BLA	70 U.S. Gal Stock Tank	086876120394	237
FG424500	BLA	150 U.S. Gal Stock Tank	086876029482	237
FG424700	BLA	300 U.S. Gal Stock Tank	086876043495	237
FG424806	BLA	Stock Tank Float Valve	075608424817	237
FG425100	YEL	Over-the-Spill® Station Kit includes Pad Dispenser, 25 Large Pads and Fasteners	086876162486	247
FG425200	YEL	Over-the-Spill® Station Pads, Large; Refill Pads for FG425100, Contains 25 Pads	086876162493	247
FG425300	YEL	Over-the-Spill® Station Pads, Medium; Refill Pads for FG425100, Contains 25 Pads	086876162509	247
FG425400	YEL	Over-the-Spill® Pad Tablet; Contains 25 Pads	086876162516	247

¹ FedEx shippable items.

Part	Color	Description	UPC	Page
FG425500	YEL	Over-the-Spill® Mini Tablet	086876193589	247
FG430000	BLA	Convertible Utility Cart	086876191523	224, 276
FG440000	BLA	Triple® Trolley, Utility-Duty with Straight Handle and 3" (7.6 cm) Casters	086876172997	218
FG440100	BLA	Triple® Trolley, Standard-Duty with User-Friendly Handle and 5" dia x .88" w (12.7 cm x 2.22 cm) Casters	086876172980	218, 279
FG440186	BLA	Caterer's Trolley transports FG940600, FG940700, and FG940800 CaterMax™ Carriers	086876155686	274
FG440300	BLA	Heavy-Duty Platform Truck	086876184433	210
FG440300	BLA	HD Platform Truck (5m 24" x 36")	086876184433	279
FG440600	BLA	Heavy-Duty Platform Truck	086876184440	210
FG443600	BLA	Heavy-Duty Platform Truck	086876184464	210
FG443600	BLA	HD Platform Truck (Med 24" x 48")	086876184464	279
FG443610	BLA	Heavy-Duty Platform Truck	086876184501	210
FG444100	BLA	Heavy-Duty Platform Truck		210
FG446200	BLA	A-Frame Panel Truck (24" x 36")		212
FG446300	BLA	A-Frame Panel Truck (24" x 48")		212
FG446400	BLA	A-Frame Panel Truck (30" x 60")		212
FG446500	BLA	Convertible A-Frame Truck (24" x 44")		208
FG446600	BLA	Heavy-Duty Platform Truck	086876184532	210
FG446610	BLA	Heavy-Duty Platform Truck	086876184556	210
FG446700	BLA	Sheet and Panel Truck (24" x 36")		212
FG446800	BLA	Sheet and Panel Truck (24" x 48")		212
FG446900	BLA	Sheet and Panel Truck (30" x 60")		212
FG447100	BLA	Heavy-Duty Platform Truck	086876184570	210
FG447200	BLA	Work-Height Platform Truck (24" x 36")		213
FG447300	BLA	Work-Height Platform Truck (24" x 48")		213
FG447400	BLA	Work-Height Platform Truck (30" x 60")		213
FG447500	BLA	5th Wheel Wagon Truck (24" x 36")		214
FG447600	BLA	5th Wheel Wagon Truck (24" x 36")		214
FG447700	BLA	5th Wheel Wagon Truck (24" x 48")		214
FG447800	BLA	5th Wheel Wagon Truck (24" x 48")		214
FG447900	BLA	5th Wheel Wagon Truck (30" x 60")		214
FG448000	BLA	5th Wheel Wagon Truck (30" x 60")		214
FG448100	BLA	Stanchion Platform Truck (24" x 36")		216
FG448200	BLA	Stanchion Platform Truck (24" x 48")		216
FG448300	BLA	Stanchion Platform Truck (30" x 60")		216
FG448400	BLA	Side Panel Platform Truck (24" x 36")		215
FG448500	BLA	Side Panel Platform Truck (24" x 36")		215
FG448600	BLA	Side Panel Platform Truck (24" x 48")		215
FG448700	BLA	Side Panel Platform Truck (30" x 60")		215
FG448800	BLA	Side Panel Platform Truck (30" x 60")		215
FG448900	BLA	Dunnage Rack (24" x 36")		217, 251
FG449000	BLA	Dunnage Rack (24" x 48")		217, 251
FG449100	BLA	Dunnage Rack (30" x 60")		217, 251
FG449200	RED	Semi-Live Skid Jack Handle		217
FG449300	BLA	Semi-Live Skid (24" x 36")		217
FG449400	BLA	Semi-Live Skid (24" x 48")		217
FG449500	BLA	Semi-Live Skid (30" x 60")		217
FG449600	BLA	Convertible Platform Truck (24" x 52")		209
FG449700	BLA	Convertible Platform Truck (24" x 52")		209
FG450008		Spray Dispenser 400 mL – White		25
FG450008		Clean Seat Soap Spray 400 mL Dispenser – White		36
FG450009		Spray Hand Soap with Moisturizers, 800 mL		25
FG450010		Spray Antibacterial Soap, 800 mL		25
FG450011		Spray Hand Soap with Moisturizers, 400 mL		25
FG450012		Spray Antibacterial Soap, 400 mL		25
FG450017		Foam Skin Care Dispenser 800 mL, 1000 mL – White		24
FG450019		Foam Hand Soap with Moisturizers, 800 mL		24
FG450026		Manual Spray Dispenser 400 mL – White		25
FG450027		Foam Free 'N' Clean Soap, 1000 mL		24
FG450030		Spray Moisturizing Hand Sanitizer – E3		25
FG450031		Foam Antibacterial Soap – E2, 800 mL		24
FG450032		Spray Moisturizing Hand Sanitizer Bottle – E3		25
FG450033		Spray Dispenser 400 mL – Black		25
FG450033		Clean Seat Soap Spray 400 mL Dispenser – Black		36
FG450034		Foam Skin Care Dispenser 800 mL, 1000 mL – Black		24
FG450088	BEIG	Utility Cart	086876169188	223
FG450088	BLA	Utility Cart	086876184259	223
FG450088	BEIG	HD 2-Shelf Utility Cart w/ Lipped Shelf (Small)	086876169188	278
FG450088	BLA	HD 2-Shelf Utility Cart w/ Lipped Shelf (Small)	086876184259	278
FG450089	BEIG	Utility Cart		223
FG450089	BLA	Utility Cart		223
FG450500	BEIG	HD 2-Shelf Utility Cart Flat Shelf (Small)	086876125078	223, 278
FG450500	BLA	HD 2-Shelf Utility Cart Flat Shelf (Small)	086876184372	223, 278
FG450589	BLA	HD 2-Shelf Utility Cart Flat Shelf (Small)		223
FG450589	BEIG	HD 2-Shelf Utility Cart Flat Shelf (Small)		223
FG451288	BLA	TradeMaster® Cart with 2-Door Cabinet, Small	086876175936	219
FG451388	BLA	TradeMaster® Cart with 4 Drawers	086876175943	219
FG452010	BLA	HD 2-Shelf Utility Cart w/ Lipped Shelf (Med) with Pneumatic Casters	086876184297	223
FG452010	BEIG	HD 2-Shelf Utility Cart w/ Lipped Shelf (Med) with Pneumatic Casters		223
FG452088	BLA	Utility Cart	086876184280	223

* Contact Customer Service for UPC information not provided.

Part	Color	Description	UPC	Page
FG452088	BEIG	Utility Cart		223
FG452088	BLA	HD 2-Shelf Utility Cart w/ Lipped Shelf (Med)	086876184280	278
FG452088	BEIG	HD 2-Shelf Utility Cart w/ Lipped Shelf (Med)		278
FG452089	BLA	Utility Cart		223
FG452089	BEIG	Utility Cart		223
FG452500	BEIG	HD 2-Shelf Utility Cart Flat Shelf (Med)	086876125092	223, 278
FG452500	BLA	HD 2-Shelf Utility Cart Flat Shelf (Med)	086876184389	223, 278
FG452589	BEIG	HD 2-Shelf Utility Cart Flat Shelf (Med)		223
FG452589	BLA	HD 2-Shelf Utility Cart Flat Shelf (Med)		223
FG453288	BLA	TradeMaster® Cart with 2-Door Cabinet, Large	086876175950	219
FG453388	BLA	TradeMaster® Cart with 4 Drawers and Cabinet, Small	086876175967	219
FG453588	BLA	TradeMaster® Professional Contractors' Cart	086876175981	219
FG454500	BEIG	HD 2-Shelf Utility Cart Flat Shelf (Large)		223
FG454500	BLA	HD 2-Shelf Utility Cart Flat Shelf (Large)		223
FG454600	BLA	HD 2-Shelf Utility Cart w/ Lipped Shelf (Large)	086876184327	223
FG454600	BEIG	HD 2-Shelf Utility Cart w/ Lipped Shelf (Large)		223
FG454610	BLA	HD 2-Shelf Utility Cart w/ Lipped Shelf (Large) with Pneumatic Casters	086876184334	223
FG454610	BEIG	HD 2-Shelf Utility Cart w/ Lipped Shelf (Large) with Pneumatic Casters		223
FG454888	BLA	TradeMaster® Cart with 4 Drawers and Cabinet, Large	086876175998	219
FG459200	0000	8" (20.3 cm) Pneumatic Caster Kit	086876169409	221
FG460800	WHT	Cube Truck	086876131895	235
FG460800	DBLUE	Cube Truck	086876157277	235
FG460800	BLA	Cube Truck	086876183986	235
FG460800	RED	Cube Truck		235
FG460800	YEL	Cube Truck		235
FG460900	BLA	Lid for 8 ft. ³ Cube Trucks	086876184051	235
FG461000	0000	Spring Kit for FG461100, FG461400 Trucks	086876155440	235
FG461100	BLA	Spring Platform Truck	086876184013	235
FG461200	WHT	Cube Truck	086876131918	235
FG461200	DBLUE	Cube Truck	086876157307	235
FG461200	BLA	Cube Truck	086876183993	235
FG461200	RED	Cube Truck		235
FG461200	YEL	Cube Truck		235
FG461300	BLA	Lid for 12 ft. ³ Cube Trucks	086876184068	235
FG461400	WHT	Cube Truck	086876131949	235
FG461400	BLA	Cube Truck	086876184006	235
FG461400	BLUE	Cube Truck		235
FG461400	RED	Cube Truck		235
FG461400	YEL	Cube Truck		235
FG461500	BLA	Lid for 14 ft. ³ Cube Trucks	086876184075	235
FG461600	WHT	Cube Truck	086876131963	235
FG461600	DBLUE	Cube Truck	086876157369	235
FG461600	BLA	Cube Truck	086876184020	235
FG461600	RED	Cube Truck		235
FG461600	YEL	Cube Truck		235
FG461673	BLUE	Recycling Cube Truck	086876194319	235
FG461700	BLA	Lid for 20 ft. ³ Cube Trucks	086876184082	235
FG461800	BLA	Spring Platform Truck	086876184044	235
FG461900	BLA	Cube Truck	086876184037	235
FG461900	BLUE	Cube Truck		235
FG461900	RED	Cube Truck		235
FG461900	YEL	Cube Truck		235
FG462500	0000	Spring Kit for FG461800, FG461900 Trucks		235
FG470800	BLA	Utility Truck, Heavy-Duty with 4" dia (10.2 cm) Casters	086876184099	235
FG471200	BLA	Utility Truck, Heavy-Duty with 4" dia (10.2 cm) Casters	086876184105	235
FG471600	BLA	Utility Truck, Heavy-Duty with 5" dia (12.7 cm) Casters	086876184112	235
FG472000	BLA	Utility Truck, Heavy-Duty with 5" dia (12.7 cm) Casters	086876184129	235
FG472600	BLA	Lid for 27 ft. ³ Cube Trucks	086876184150	235
FG472700	BLA	Utility Truck, Heavy-Duty with 5" dia (12.7 cm) Corner Casters	086876184136	235
FG472741	BLA	Towable Utility Truck, Heavy-Duty	086876184143	235
FG4870001		Microburst® Duet Dispenser White/Grey Pearl		9
FG4870002		Microburst® Duet Dispenser Black/Black Pearl		9
FG4870052		ecoUrinal™ Cartridge		32
FG4870053		Urinal Cartridge Tool		32
FG4870055		Microburst® Duet Dispenser Black/Chrome		9
FG4870056		Microburst® Duet Dispenser White/White		9
FG4870108		ecoBug – Enzyme Tablet		32
FG4870109		ecoBug – Enzyme Tablet		32
FG4870178		Foam Antibacterial Soap – E2, 1000 mL		24
FG4870465		One Shot® Foam Dispenser Low Profile Metal – Polished Chrome		18
FG500288	CLR	Linear Low-Density Can Liners fit FG295200, FG295500, FG295600, FG614200	086876153569	151
FG500388	CLR	Linear Low-Density Can Liners fit FG261000, FG294700, FG295700, FG307120	086876153576	151
FG500408		AutoClean® LED Dispenser – Chrome (Kit w/ 1½" Connector)		35
FG500409		AutoClean® LED Dispenser – Chrome (Kit w/ ¾" Connector)		35

Part	Color	Description	UPC	Page
FG500410		AutoClean® LED Dispenser – Chrome (Kit w/ 1½" Connector)		35
FG500475		AutoClean® Service Dispenser – Chrome (Kit w/ 1½" Connector)		35
FG500476		AutoClean® Service Dispenser – Chrome (Kit w/ ¾" Connector)		35
FG500477		AutoClean® Service Dispenser – Chrome (Kit w/ 1½" Connector)		35
FG500478		Milano in Polished Chrome		28
FG500479		Milano in Polished Chrome		29
FG500480		Milano in Polished Chrome		28
FG500481		Milano in Polished Chrome		28
FG500482		Milano in Polished Chrome		29
FG500483		Milano in Polished Chrome		28
FG500484		Milano in Polished Chrome		28
FG500485		Milano in Polished Chrome		29
FG500488	GRAY	Linear Low-Density Can Liners fit FG354600, FG816088, FG818488, FG818588, FG614300, FG614400, FG617700	086876153583	151
FG500494		Milano in Polished Brass		28
FG500495		Milano in Polished Brass		29
FG500551		TCell™ Dispenser – White and Cucumber Melon Refill		14
FG500552		TCell™ Dispenser – White and Mango Blossom Refill		14
FG500554		Verona in Polished Chrome		28
FG500555		Sienna in Polished Chrome		28
FG500556		Capri in Polished Chrome		28
FG500564		Milano in Satin Nickel		28
FG500565		Milano in Satin Nickel		28
FG500566		Milano in Satin Nickel		29
FG500572		Verona in Polished Chrome		28
FG500573		Verona in Polished Chrome		29
FG500574		Sienna in Polished Chrome		28
FG500575		Sienna in Polished Chrome		29
FG500576		Capri in Polished Chrome		28
FG500577		Capri in Polished Chrome		29
FG500588	GRAY	Linear Low-Density Can Liners fit FG352000, FG356800, FG356900, FG782200, FG782300, FG817088, FG818088, FG818288, FG818588	086876153590	151
FG500590		AutoClean® LCD Dispenser – Chrome (Kit w/ ¾" Connector)		35
FG500591		AutoClean® LCD Dispenser – Chrome (Kit w/ 1½" Connector)		35
FG500592		AutoClean® LCD Dispenser – Chrome (Kit w/ 1¾" Connector)		35
FG500609		Venetian 3.5" in Polished Chrome		28
FG500610		Venetian 3.5" in Polished Chrome		28
FG500611		Venetian 3.5" in Polished Chrome		29
FG500615		Milano in Polished Chrome		28
FG500616		Milano in Polished Chrome		28
FG500617		Milano in Polished Chrome		29
FG500624		Starter Kit – Lotion Soap with Moisturizers, 800 mL		24
FG500625		Starter Kit – Lotion Soap with Moisturizers, 400 mL		25
FG500626		Spray Hand Sanitizer Starter Kit		25
FG500640		Verona in Polished Chrome		28
FG500641		Verona in Polished Chrome		28
FG500642		Verona in Polished Chrome		29
FG500645		Sienna in Polished Chrome		28
FG500646		Sienna in Polished Chrome		28
FG500647		Sienna in Polished Chrome		29
FG500648		Verona in Polished Chrome		28
FG500649		Verona in Polished Chrome		28
FG500651		Capri in Polished Chrome		28
FG500652		Capri in Polished Chrome		28
FG500653		Capri in Polished Chrome		29
FG500688	GRAY	Linear Low-Density Can Liners fit FG262000, FG614687	086876153606	151
FG500788	GRAY	Linear Low-Density Can Liners fit FG263200, FG263400, FG263246, FG263256	086876155884	151
FG500888	GRAY	Linear Low-Density Can Liners fit FG264100, FG264300, FG395800, FG395900, FG905800, FG99P000, FG264346, FG264356, FG99P100, FG965100, FG965200		151
FG500888	CLR	Linear Low-Density Can Liners fit FG264100, FG264300, FG395800, FG395900, FG905800, FG99P000, FG264346, FG264356, FG99P100, FG965100, FG965200		151
FG500988	GRAY	Linear Low-Density Can Liners fit FG354000, FG354100, FG396600, FG396700, FG614500, FG614600, FG818288, FG355400, FG3542200	086876155921	151
FG501088	GRAY	50-Gal (208.2-L) Drum	086876155938	151
FG501188	GRAY	Linear Low-Density Can Liners fit FG265500	086876155945	151
FG501388	GRAY	Linear Low-Density Can Liners fit FG256800, FG256806, FG9W2700, FG9W2706	086876155952	151
FG501388	CLR	Linear Low-Density Can Liners fit FG256800, FG256806, FG9W2700, FG9W2706		151

¹ FedEx shippable items.

* Contact Customer Service for UPC information not provided.

Part	Color	Description	UPC	Page
FG501688	GRAY	Linear Low-Density Can Liners fit FG351700, FG352600, FG396300, FG396400, FG396500, FG396800, FG396900, FG397000, FG397100, FG397200, FG397500, FG843000, FG917100, FG917200, FG917300	086876155976	151
FG502888	GRAY	50-Gal (189.3-L) Container FG9W2700, FG9W2706	086876155983	151
FG505012		Stock Tank Drain Plug Kit	071691147305	237
FG507600	CLR	High-Density Coreless Roll Can Liners	086876145618	151
FG507900	CLR	High-Density Coreless Roll Can Liners	086876145649	151
FG511400	OWHT	SeBreeze® Adjustable Fan Dispenser	086876126082	16
FG513700	OWHT	Economy SeBreeze® Aerosol Odor Neutralizing Unit	086876156799	13
FG513800	0000	SeBreeze® 3000 Series Spring Garden Fragrance Aerosol Canister for 5137 and 5169 Units	086876146219	13
FG513900	0000	SeBreeze® 3000 Series Citrus Breeze Fragrance Aerosol Canister for 5137 and 5169 Units	086876146226	13
FG514500	0000	SeBreeze® 9000 Series Orchard Harvest Odor Neutralizer Aerosol Canister for 5137 and 5169 Units	086876168754	13
FG515800	0000	SeBreeze® 9000 Series Spring Garden Odor Neutralizer Aerosol Canister for 5137 and 5169 Units	086876157178	13
FG515900	0000	SeBreeze® 9000 Series Country Linen Odor Neutralizer Aerosol Canister for 5137 and 5169 Units	086876157185	13
FG516000	0000	SeBreeze® 9000 Series Citrus Breeze Odor Neutralizer Aerosol Canister for 5137 and 5169 Units	086876157192	13
FG516800	0000	SeBreeze® 9000 Series Aerosol Variety Pack, Contains 2 ea. of 5158, 5145, 5160	086876157208	13
FG516900	OWHT	SeBreeze® Aerosol Programmable Plus™ Odor Neutralizing Unit	086876162585	13
FG564000	BLA	7.5-Cu.-Ft. Low Wheel Cart (Unassembled)	086876185461	239
FG564200	BLA	7.5-Cu.-Ft. Big Wheel® Cart	086876185904	238
FG564210	BLA	7.5-Cu.-Ft. Heavy-Duty Big Wheel® Cart	086876048308	239
FG564261	BLA	7.5-Cu.-Ft. Big Wheel® Cart (Unassembled)	086876185447	238
FG565461	BLA	3.5-Cu.-Ft. Big Wheel® Cart (Unassembled)	086876000146	238
FG565861	BLA	6.5-Cu.-Ft. Contractor Wheelbarrow (Unassembled)	086876185980	239
FG565961	BLA	6.5-Cu.-Ft. Two-Wheel Contractor Wheelbarrow (Unassembled)	086876185997	239
FG566000	BLA	10-Cu.-Ft. Tractor Cart (Assembled)	086876063073	238
FG566261	BLA	8-Cu.-Ft. Tractor Cart (Unassembled)	086876185966	238
FG566361	BLA	15-Cu.-Ft. Tractor Cart (Unassembled), Black	086876185973	238
FG571473	BLUE	14-Gallon Recycling Box	086876201161	148
FG571473	GRN	14-Gallon Recycling Box	086876201175	148
FG571873	BLUE	18-Gallon Recycling Box	086876201185	148
FG571873	GRN	18-Gallon Recycling Box	086876201192	148
FG572000	WHT	Round Storage Container	086876131222	257
FG572024	CLR	Round Storage Container	086876131239	257
FG572100	WHT	Round Storage Container	086876131246	257
FG572124	CLR	Round Storage Container	086876131253	257
FG572200	YEL	Lid for FG572000, FG572024, FG572100, FG572124 Round Storage Containers	086876131260	257
FG572200	NAT	Lid for FG572000, FG572024, FG572100, FG572124 Round Storage Containers		257
FG572300	WHT	Round Storage Container		257
FG572324	CLR	Round Storage Container	086876131284	257
FG572400	WHT	Round Storage Container		257
FG572424	CLR	Round Storage Container	086876131307	257
FG572500	YEL	Lid for FG572300, FG572324, FG572400, FG572424 Round Storage Containers	086876131314	257
FG572500	NAT	Lid for FG572300, FG572324, FG572400, FG572424 Round Storage Containers	086876179132	257
FG572600	WHT	Round Storage Container	086876131321	257
FG572624	CLR	Round Storage Container	086876131338	257
FG572700	WHT	Round Storage Container	086876131345	257
FG572724	CLR	Round Storage Container	086876131352	257
FG572800	WHT	Round Storage Container		257
FG572824	CLR	Round Storage Container	086876131376	257
FG572900	WHT	Round Storage Container with Bail	086876131383	257
FG572900	GRAY	Round Storage Container with Bail		257
FG572924	CLR	Round Storage Container with Bail	086876131390	257
FG573000	YEL	Lid for FG572600, FG572624, FG572700, FG572724, FG572800, FG572824, FG572900, FG572924 Round Storage Containers	086876131406	257
FG573000	NAT	Lid for FG572600, FG572624, FG572700, FG572724, FG572800, FG572824, FG572900, FG572924 Round Storage Containers	086876179149	257
FG605SRW		Dishwasher-Safe Mechanical Portion Control Scale	077177404893	266
FG605SRWQ		Dishwasher-Safe Mechanical Portion Control Scale w/ QuickStop	077177404801	266
FG611000	YEL	Hanging Safety Sign with Multilingual "Caution" Imprint and Falling Person Symbol	086876159677	246
FG611200	YEL	Floor Sign with Multilingual "Caution" Imprint, 2-Sided	086876032994	242
FG611277	YEL	Floor Sign with "Caution Wet Floor" Imprint, 2-Sided	086876141702	242

¹ FedEx shippable items.

Part	Color	Description	UPC	Page
FG611278	YEL	Floor Sign with Multilingual "Closed" Imprint, 2-Sided	086876123470	242
FG611400	YEL	Floor Sign with Multilingual "Caution" Imprint, 4-Sided	086876123517	242
FG611477	YEL	Floor Sign with "Caution Wet Floor" Imprint, 4-Sided	086876141719	242
FG611478	YEL	Floor Sign with Multilingual "Closed" Imprint, 4-Sided	086876123531	242
FG612788	YEL	Side Press Wringer for WaveBrake® Mop Buckets	086876176575	63
FG612788	RED	Side Press Wringer for WaveBrake® Mop Buckets	086876176582	63
FG612788	GRN	Side Press Wringer for WaveBrake® Mop Buckets	086876176599	63
FG612788	BLUE	Side Press Wringer for WaveBrake® Mop Buckets	086876176605	63
FG612788	BRN	Side Press Wringer for WaveBrake® Mop Buckets	086876178258	63
FG614000	WHT	Sanitary Napkin Receptacle with Rigid Liner	086876034165	38
FG614100	0000	Waxed Bags for Sanitary Napkin Receptacle 50 bags/bundle; 250 per carton		38
FG614200	WHT	Step-On Can with Rigid Liner	086876034219	141
FG614200	YEL	Step-On Can with Rigid Liner		141
FG614300	BEIG	Step-On Container	086876057010	141
FG614300	RED	Step-On Container	086876057027	141
FG614300	WHT	Step-On Container	086876057034	141
FG614300	YEL	Step-On Container		141
FG614400	BEIG	Step-On Container	086876057041	141
FG614400	RED	Step-On Container	086876057058	141
FG614400	WHT	Step-On Container	086876057065	141
FG614400	YEL	Step-On Container		141
FG614500	BEIG	Step-On Container	086876052565	141
FG614500	WHT	Step-On Container	086876052572	141
FG614500	RED	Step-On Container	086876052893	141
FG614500	YEL	Step-On Container		141
FG614600	BEIG	Mobile Step-On Container	086876052589	141
FG614600	RED	Mobile Step-On Container	086876052596	141
FG614600	WHT	Mobile Step-On Container	086876052602	141
FG614600	YEL	Mobile Step-On Container		141
FG614687	BLA	23-Gallon Stainless Steel Step-On Container	086876188240	142
FG614687	RED	23-Gallon Stainless Steel Step-On Container	086876188257	142
FG614700	LPLAT	30-Gallon Step-On Container	086876188264	142
FG614700	RED	30-Gallon Step-On Container	086876188271	142
FG614787	BLA	30-Gallon Stainless Steel Step-On Container	086876188288	142
FG614787	RED	30-Gallon Stainless Steel Step-On Container	086876188295	142
FG616200	0000	Dual Waste Wire Bag Holders	086876203912	102
FG616300	0000	Single Waste Wire Bag Holder	086876203905	102
FG616700	BLA	Protective Hood	086876193343	105
FG617000	BLA	Locking Door Kit	086876193350	105
FG617100	BLA	Under Deck Glass Rack Holder	086876193367	105
FG617388	BLA	Cleaning Cart with Zippered Yellow Vinyl Bag	086876192292	99
FG617400	BLA	Mobile Fabric Bag	086876193374	105
FG617600	BLA	Fabric Divided Bag	086876193381	105
FG617700	BEIG	Pedal Rolltop Container		147
FG617800	BLA	Fabric Literature Organizer	086876193398	105
FG617900	BLA	Storage Compartment/Trash Cover	086876180749	99, 103
FG618000	BLA	Trades Cart with 5" (12.7 cm) Casters includes 2 parts boxes and 4 parts bins	086876184419	220
FG618088	BLA	Trades Cart with Locking Cabinet includes 2 parts boxes and 4 parts bins	086876184426	220
FG618100	YEL	Locking Cabinet Doors	086876194650	99, 103
FG618300	YEL	Vinyl Replacement Bag with Zipper for FG617388 Cleaning Cart		99
FG618400	YEL	20' (6.1 m) Barrier Chain for FG611400 and Safety Cones	086876130508	242, 245
FG618688	YEL	WaveBrake® 44-Qt Side Press Combo	086876191578	62
FG618700	BLA	Heavy-Duty Fabric Bag – Medium	086876193404	105
FG618800	BLA	Heavy-Duty Fabric Bag – Long	086876193411	105
FG618900	PLAT	Full-Size Housekeeping Cart	086876162257	106
FG618900	BLA	Full-Size Housekeeping Cart		106
FG619000	BLA	Compact Housekeeping Cart	086876192414	106
FG619100	BLA	Full-Size Housekeeping Cart with Doors	086876192421	106
FG619200	BLA	Compact Housekeeping Cart with Doors	086876192438	106
FG619400	STL	Pail and Mop Strainer Combination	086876167528	77
FG619500	PLAT	Adjustable Shelf Kit for Classic Housekeeping Carts	086876162325	107
FG619500	BLA	Adjustable Shelf Kit for Classic Housekeeping Carts	086876192452	107
FG619600	PLAT	Glass Rack for Classic Housekeeping Carts	086876162349	107
FG619600	BLA	Glass Rack for Classic Housekeeping Carts	086876192469	107
FG619700	BRN	Locking Door Kit for Classic Housekeeping Carts	086876162332	107
FG619700	BLA	Locking Door Kit for Classic Housekeeping Carts	086876192476	107
FG619900	BRN	Utility Drawer with Lock	086876162356	107
FG619900	BLA	Utility Drawer with Lock		107
FG624300	GRAY	Rigid Liner for FG614300 Container	086876057072	141
FG624400	GRAY	Rigid Liner for FG614400 Container	086876057089	141
FG624500	GRAY	Rigid Liner for FG614500 Container	086876052619	141
FG624600	GRAY	Rigid Liner for FG614600 Container	086876052626	141
FG625SRW		Dishwasher-Safe Mechanical Portion Control Scale	077177404825	266

* Contact Customer Service for UPC information not provided.

Part	Color	Description	UPC	Page
FG627600	YEL	Safety Cone 36" (91.4 cm) with Multilingual "Caution" Imprint	086876162660	245
FG627677	YEL	Safety Cone 36" (91.4 cm) with Multilingual "Caution, Wet Floor" Imprint	086876162677	245
FG627687	YEL	Safety Cone 36" (91.4 cm) with Multilingual "Caution, Safety First" Imprint	086876162684	245
FG627700	YEL	Safety Cone 25.75" (65.4 cm) with Multilingual "Caution" Imprint	086876162622	245
FG627777	YEL	Safety Cone 25.75" (65.4 cm) with Multilingual "Caution, Wet Floor" Imprint	086876162639	245
FG628400	BLA	Weight Ring – Single for all 36" (91.4 cm) Safety Cones	086876162745	200, 245
FG628600	BLA	Lock-In Sign Holder for 25 3/4" (65.4 cm) and 36" (91.4 cm) Safety Cones	086876162752	245
FG628700	YEL	Cone Barricade System Consists of FG627600, (1) Belt Cassette, and (1) Double Weight Ring	086876162738	244, 245
FG630000	BLA	Premium Linen Hamper (uses 30-Gallon Can Liner)	086876188301	142
FG630100	YEL	Toilet Bowl Brush, Hardwood Handle, Polypropylene Fill	086876141986	92
FG630200	CLR	Space-Saving Square Container	086876043983	256
FG630400	CLR	Space-Saving Square Container	086876043990	256
FG630600	CLR	Space-Saving Square Container	086876044003	256
FG630800	CLR	Space-Saving Square Container	086876044010	256
FG631000	WHT	Toilet Bowl Brush, Plastic Handle, Polypropylene Fill	086876007213	92
FG631100	WHT	Toilet Bowl Brush Holder, fits FG631000 Brush	086876007220	92
FG631200	CLR	Space-Saving Square Container	086876044027	256
FG631800	CLR	Space-Saving Square Container	086876044034	256
FG632000	BRN	Toilet Bowl Brush, Plastic Handle, Polypropylene Fill	086876007312	92
FG632200	CLR	Space-Saving Square Container	086876044041	256
FG632SRW		Dishwasher-Safe Mechanical Portion Control Scale	077177404856	266
FG632SRWQ		Dishwasher-Safe Mechanical Portion Control Scale w/ QuickStop	077177404818	266
FG633700	BLUE	Floor Scrub, Plastic Block, Bi-level, Polypropylene Fill	086876141993	91
FG634100	BLA	Plastic Block Counter Brush, Tampico Fill with 8" (20.3 cm) Bristle Coverage	086876142013	90
FG634200	SILV	Plastic Block Counter Brush, Flagged Polypropylene Fill with 8" (20.3 cm) Bristle Coverage	086876142020	90
FG635000	BLA	Premium Linen Hamper Bag	086876188318	142
FG635100	LAC	Wood Handle, Threaded, Lacquered	086876007527	89
FG635200	NAT	Wood Handle, Tapered, Sanded	086876007534	89
FG635500	GRAY	Aluminum Handle, Threaded Plastic Tip, Vinyl Grip		89
FG635700	BLA	Super Self-Locking Wood Handle, Threaded Metal Tip	086876128659	89
FG636100	LAC	Wood Handle, Threaded, Lacquered	086876007596	89
FG636200	NAT	Wood Handle, Tapered, Sanded	086876007602	89
FG636400	LAC	Wood Handle, Threaded Metal Tip, Lacquered	086876007640	89
FG637300	BRN	Lobby Broom, 100% Corn Fill	086876007770	94
FG637400	BLA	Executive Series™ Lobby Broom, Polypropylene Fill	086876154962	94
FG637500	GRAY	Broom, 1" dia (2.5 cm) Vinyl-Coated Metal Handle, Flagged Polypropylene Fill	086876142129	87
FG638100	RED	Corn Broom, Standard, 1" dia (2.5 cm) Stained/Lacquered Handle	086876031409	87
FG638300	BLUE	Corn Broom, Warehouse, 1.13" dia (2.9 cm) Stained/Lacquered Handle	086876007824	87
FG638400	ORAN	Corn Broom, Warehouse, 1.13" dia (2.9 cm) Stained/Lacquered Handle	086876007855	87
FG638500	GRAY	Broom, 1" dia (2.5 cm) Metal Handle, Flagged Polypropylene Fill	086876142167	87
FG638906	BLA	Jumbo Smooth Sweep Angle Broom, 1 1/8" dia (4.76 cm) Black Metal Handle, Polypropylene Fill	086876194081	87
FG639700	GRAY	Broom Replacement Head, Thread fits FG635100, FG635500 Handles	086876153514	87
FG643500	BRNZ	Steel Sponge Mop with Cellulose Head	086876034790	77
FG643600	YEL	Steel Cellulose Replacement Head	086876034806	77
FG648200	COBLT	Iron Handle Scrub Brush, Polypropylene Fill	086876160499	92
FG650900	WHT	Lid for FG630200, FG630400, FG630600, FG630800, FG9F0300, FG9F0400, FG9F0500, FG9F0600 Space-Saving Containers	086876044102	256
FG652300	WHT	Lid for FG631200, FG631800, FG632200, FG9F0700, FG9F0800, FG9F0900 Space-Saving Containers	086876044140	256
FG703504	WHT	Safti-Grip® Bath Mat, Medium	071691703563	39
FG703504	BSTON	Safti-Grip® Bath Mat, Medium	086876180084	39
FG704104	BSTON	Safti-Grip® Bath Mat, Large	086876013986	39
FG704104	WHT	Safti-Grip® Bath Mat, Large	086876159363	39
FG704304	BSTON	Safti-Grip® Bath Mat, XLarge	086876142372	39
FG704304	WHT	Safti-Grip® Bath Mat, XLarge	086876180107	39
FG711204	WHT	Safti-Grip® Shower Mat	086876180121	39
FG738000	YEL	Tandem™ 31-Qt Bucket and Wringer Combo	086876188233	63
FG747000	YEL	WaveBrake® Bucket	086876176520	63
FG748018	YEL	WaveBrake® Side Press Combo	086876176407	62
FG750084		Capri in Polished Chrome		28
FG750085		Capri in Polished Chrome		28

Part	Color	Description	UPC	Page
FG750095		Venetian 5.5" in Polished Chrome		29
FG750096		Venetian 5.5" in Polished Chrome		28
FG750099		Venetian 5.5" in Polished Chrome		28
FG750111		Enriched Foam Antibacterial E2 Hand Soap – E2		21
FG750112		Enriched Foam Hand Soap with Moisturizers		21
FG750127		Auto Foam Dispenser – Black/Black Pearl		20
FG750138		Auto Foam Dispenser – White/Black Pearl		20
FG750139		Auto Foam Dispenser – Black/Grey Pearl		20
FG750140		Auto Foam Dispenser – White/Grey Pearl		20
FG750172		Venetian 3.5" in Polished Chrome		28
FG750173		Venetian 3.5" in Polished Chrome		28
FG750174		Venetian 3.5" in Polished Chrome		29
FG750176		Manual Spray Dispenser, 400 mL – Metallic		25
FG750181		Milano in Polished Brass		28
FG750182		Milano in Polished Brass		28
FG750183		Milano in Polished Brass		29
FG750196		One Shot® Liquid Dispenser Low-Profile Metal – Brilliant Brass		19
FG750243		Sanitary Bin 3 Gallon – White		38
FG750244		Sanitary Bin 3 Gallon – Gray		38
FG750269		Venetian 3.5" in Polished Chrome		28
FG750270		Venetian 3.5" in Polished Chrome		28
FG750271		Venetian 3.5" in Polished Chrome		29
FG750295		Global Collection – Kilimanjaro		12
FG750296		Global Collection – Island Cocktail		12
FG750297		Global Collection – American Diner		12
FG750298		Global Collection – Marrakesh		12
FG750299		Global Collection – Mediterranean Charm		12
FG750300		Global Collection – Oriental Nights		12
FG750301		Global Collection – Ice Age		12
FG750302		Global Collection – Rainforest		12
FG750324		Gel – Green Citrus		17
FG750327		Gel – Island Melon		17
FG750328		Gel – Vanilla Coconut		17
FG750333		Auto Foam Starter Kit – White/Grey Pearl (dispenser, hand wash refill, 4 C batteries)		21
FG750334		Auto Foam Starter Kit – Black/Black Pearl (dispenser, hand wash refill, 4 C batteries)		21
FG750339		One Shot® Foam Dispenser Low Profile – Polished Chrome		18
FG750353		Venetian 5.5" in Polished Chrome		28
FG750354		Venetian 5.5" in Polished Chrome		28
FG750355		Venetian 5.5" in Polished Chrome		29
FG750362		Microburst™ 3000 Refill – Raspberry Green Tea		11
FG750363		Microburst™ 3000 Refill – Cucumber Melon		11
FG750365		Microburst™ 9000 Refill – Raspberry Green Tea		11
FG750366		Microburst™ 9000 Refill – Cucumber Melon		11
FG750375		SaniCell™ Tank – Clear		33
FG750382		Foam Skin Care Dispenser 800 mL, 1000 mL – Stainless Steel		24
FG750383		Foam Hand Soap with Moisturizers, 1000 mL		24
FG750386		Enriched Foam Hand Soap with Moisturizers		18
FG750389		Enriched Foam Free 'N' Clean Soap – E1		18
FG750390		Enriched Foam Free 'N' Clean Soap – E1		18
FG750399		Milano in Polished Chrome		28
FG750411		Auto Foam Dispenser – Black/Chrome		20
FG750443		Sanitary Bin 3-Gallon Liners – 15 per roll		38
FG750466		Global Collection – Variety Pack		12
FG750517		Enriched Foam Hand Soap with Moisturizers		18
FG750537		TCell™ Refill – Sugar Cookie		15
FG750590		Foam Alcohol Hand Sanitizer, 800 mL		24
FG750591		Enriched Foam Alcohol Hand Sanitizer – E3		21
FG750592		Foam Alcohol-Free Hand Sanitizer, 800 mL		24
FG750593		Enriched Foam Alcohol-Free Hand Sanitizer		21
FG750596		Verona in Polished Chrome		28
FG750597		Verona in Polished Chrome		28
FG750598		Verona in Polished Chrome		29
FG750600		Venetian 5.5" Polished Chrome Wall Mount 8" Center Set		29
FG750602		Venetian 5.5" Polished Chrome Wall Mount 4" Center Set		29
FG750604		Venetian 5.5" Polished Chrome Wall Mount 8" Center Set		29
FG750605		Venetian 5.5" Polished Chrome Wall Mount 4" Center Set		29
FG750607		Venetian 3.5" Polished Chrome Wall Mount 4" Center Set		29
FG750608		Venetian 3.5" Polished Chrome Wall Mount 8" Center Set		29
FG750612		Venetian 3.5" Polished Chrome Wall Mount 8" Center Set		29
FG750613		Venetian 3.5" Polished Chrome Wall Mount 4" Center Set		29
FG750645		Sienna in Polished Chrome		28
FG750824		Hand Sanitizer Station (Metal Stand) – Black		21
FG750831		Auto Flush® Tank White		31
FG750905		TCell™ Refill – Vanilla Cream		15
FG750907		TCell™ Refill – Apple Cinnamon		15
FG751001		Foam Hair and Body Wash, 800 mL		24

¹ FedEx shippable items.

* Contact Customer Service for UPC information not provided.

Part	Color	Description	UPC	Page
FG751058		Auto Foam Starter Kit – Black/Chrome (dispenser, hand wash refill, 4 C batteries) ecoUrinal™		21
FG751220		WaveBrake® Bucket, no Casters		32
FG757079	YEL	WaveBrake® Bucket, no Casters		63
FG757079	RED	WaveBrake® Bucket, no Casters		63
FG757079	GRN	WaveBrake® Bucket, no Casters		63
FG757079	BLUE	WaveBrake® Bucket, no Casters		63
FG757088	YEL	WaveBrake® Bucket	086876176537	63
FG757088	RED	WaveBrake® Bucket	086876176544	63
FG757088	BLUE	WaveBrake® Bucket	086876176568	63
FG757088	GRN	WaveBrake® Bucket	086876176582	63
FG757088	BRN	WaveBrake® Bucket	086876178241	63
FG757188	YEL	WaveBrake® Bucket, no Casters	086876179262	63
FG757188	RED	WaveBrake® Bucket, no Casters	086876179309	63
FG757188	GRN	WaveBrake® Bucket, no Casters	086876179316	63
FG757188	BLUE	WaveBrake® Bucket, no Casters	086876179323	63
FG757579	YEL	Down Press Wringer for WaveBrake® Bucket		63
FG757579	RED	Down Press Wringer for WaveBrake® Bucket		63
FG757579	GRN	Down Press Wringer for WaveBrake® Bucket		63
FG757579	BRN	Down Press Wringer for WaveBrake® Bucket		63
FG757579	BLUE	Down Press Wringer for WaveBrake® Bucket		63
FG757588	YEL	Down Press Wringer for WaveBrake® Bucket	086876179231	63
FG757588	BRN	Down Press Wringer for WaveBrake® Bucket	086876179248	63
FG757588	RED	Down Press Wringer for WaveBrake® Bucket	086876179330	63
FG757588	GRN	Down Press Wringer for WaveBrake® Bucket	086876179347	63
FG757588	BLUE	Down Press Wringer for WaveBrake® Bucket	086876179354	63
FG757688	YEL	WaveBrake® 44-Qt Down Press Combo	086876191585	62
FG757788	YEL	WaveBrake® Down Press Combo	086876179156	60
FG757788	BRN	WaveBrake® Down Press Combo	086876179170	60
FG757888	RED	WaveBrake® Down Press Combo	086876179279	60
FG757888	GRN	WaveBrake® Down Press Combo	086876179286	60
FG757888	BLUE	WaveBrake® Down Press Combo	086876179293	60
FG757900	YEL	WaveBrake® Down Press Institutional Combo		60
FG757900	BRN	WaveBrake® Down Press Institutional Combo		60
FG758088	YEL	WaveBrake® Side Press Combo	086876176421	60
FG758088	BRN	WaveBrake® Side Press Combo	086876176513	60
FG758888	RED	WaveBrake® Side Press Combo	086876176483	60
FG758888	GRN	WaveBrake® Side Press Combo	086876176490	60
FG758888	BLUE	WaveBrake® Side Press Combo	086876176506	60
FG759088	YEL	WaveBrake® Institutional Combo	086876179187	60
FG767700	YEL	WaveBrake® Dual-Water Down Press Combo	086876179200	61
FG768000	YEL	WaveBrake® Dual-Water Side Press Combo	086876179194	61
FG772000	BLA	Structural Foam Tack Box	071691152705	236
FG773488	BLA	5-Drawer Mobile Work Center	086876160031	220
FG777700	YEL	WaveBrake® Mopping Trolley Down Press	086876179224	61
FG777700	RED	WaveBrake® Mopping Trolley Down Press	086876180220	61
FG777700	BLUE	WaveBrake® Mopping Trolley Down Press	086876180237	61
FG777700	GRN	WaveBrake® Mopping Trolley Down Press	086876180244	61
FG778000	YEL	WaveBrake® Mopping Trolley Side Press	086876179217	61
FG780200	BLA	Tool Box	086876184846	236
FG780400	BLA	Tool Box	086876184853	236
FG780508	BLA	Sturdy Chair™ Youth Seat with Wheels	086876204704	282
FG780508	PLAT	Sturdy Chair™ Youth Seat with Wheels	086876204718	282
FG780508	DGRN	Sturdy Chair™ Youth Seat with Wheels	086876204728	282
FG780608	BLA	Sturdy Chair™ Youth Seat without Wheels	086876204735	282
FG780608	PLAT	Sturdy Chair™ Youth Seat without Wheels	086876204742	282
FG780608	DGRN	Sturdy Chair™ Youth Seat without Wheels	086876204759	282
FG781408	BLA	Sturdy Chair™ Youth Seat, RTA (ready to assemble), No Wheels	086876204766	282
FG781408	PLAT	Sturdy Chair™ Youth Seat, RTA (ready to assemble), No Wheels	086876204773	282
FG781408	DGRN	Sturdy Chair™ Youth Seat, RTA (ready to assemble), No Wheels	086876204780	282
FG781588	PLAT	Tray for FG780508, FG780608, and FG781408 Chairs	086876188127	282
FG781588	DBLU	Tray for FG780508, FG780608, and FG781408 Chairs		282
FG781588	DGRN	Tray for FG780508, FG780608, and FG781408 Chairs		282
FG781588	RED	Tray for FG780508, FG780608, and FG781408 Chairs		282
FG781588	BRN	Tray for FG780508, FG780608, and FG781408 Chairs		282
FG781588	BLA	Tray for FG780508, FG780608, and FG781408 Chairs		282
FG781788	WHT	Protective Liners for Baby-Changing Stations, Laminated 2-Ply Tissue Paper	086876143546	39, 283
FG781888	LPLAT	Baby-Changing Station Horizontal	086876192582	39, 283
FG781988	LPLAT	Baby-Changing Station Vertical	086876192599	39, 283
FG782200	BEIG	Slim Jim® Wall-Mounted Container	086876125511	140
FG782200	BRN	Slim Jim® Wall-Mounted Container		140
FG792020	BEIG	Untouchable® Square Container with Swing Lid Combo	086876191479	137
FG805RWQ		Washable Mechanical Portion Control Scale w/ QuickStop	077177404658	266
FG805SRWQ		Dishwasher-Safe Mechanical Portion Control Scale w/ QuickStop	077177404689	266
FG805W		Washable Mechanical Portion Control Scale	077177404672	266
FG810BW		Washable Mechanical Portion Control Scale	077177404696	266

Part	Color	Description	UPC	Page
FG810W		Washable Mechanical Portion Control Scale	077177404702	266
FG816088	BEIG	Marshal® Classic Containers	086876157017	165
FG816088	BLA	Marshal® Classic Containers	086876157024	165
FG816088	BRN	Marshal® Classic Containers	086876157031	165
FG816088	OWHT	Marshal® Classic Containers	086876157048	165
FG817088	BEIG	Marshal® Classic Containers	086876156881	165
FG817088	BLA	Marshal® Classic Containers	086876156898	165
FG817088	BRN	Marshal® Classic Containers	086876156904	165
FG817088	OWHT	Marshal® Classic Containers	086876156911	165
FG818088	BEIG	Ash/Trash Classic Container with Doors	086876156935	202
FG818088	BRN	Ash/Trash Classic Container with Doors	086876156959	202
FG818288	BEIG	Ash/Trash Classic Container without Doors	086876156973	202
FG818488	BEIG	Ash/Trash Classic Container with Doors	086876157062	202
FG818588	BEIG	Ash/Trash Classic Container without Doors	086876157109	202
FG820BW		Washable Mechanical Portion Control Scale	077177404719	266
FG820SW		Dishwasher-Safe Mechanical Portion Control Scale	077177404726	266
FG820W		Washable Mechanical Portion Control Scale	077177404733	266
FG8315AS	WHT	Measuring Cup Set	071691005063	260
FG8316AS	WHT	Measuring Spoon Set	071691831631	260
FG832BW		Washable Mechanical Portion Control Scale	077177404740	266
FG832RW		Washable Mechanical Portion Control Scale	077177405013	266
FG832RWQ		Washable Mechanical Portion Control Scale w/ QuickStop	077177404788	266
FG832SRW		Dishwasher-Safe Mechanical Portion Control Scale	077177405006	266
FG832SRWQ		Dishwasher-Safe Mechanical Portion Control Scale w/ QuickStop	077177404771	266
FG832W		Washable Mechanical Portion Control Scale	077177404764	266
FG832WQ		Washable Mechanical Portion Control Scale w/ QuickStop	077177404757	266
FG840BW		Washable Mechanical Portion Control Scale	077177494795	266
FG840SW		Dishwasher-Safe Mechanical Portion Control Scale		266
FG840W		Washable Mechanical Portion Control Scale	077177404665	266
FG843088	BRN	35-Gallon Ranger® Container	086876187236	192
FG843088	BEIG	35-Gallon Ranger® Container	086876187243	192
FG843088	BLA	35-Gallon Ranger® Container	086876187960	192
FG905800	BLA	Atrium® Classic Container with Funnel Top	086876156379	159
FG905886	WGRAN	Atrium® Classic Container with Funnel Top		159
FG907900	HSILV	Atrium® Aluminum Container Open-Top	086876159165	161
FG917188	BLA	45-Gallon Ranger® Container with 2 Doors	086876187250	192
FG917188	BEIG	45-Gallon Ranger® Container with 2 Doors	086876187267	192
FG917388	BLA	45-Gallon Ranger® Container with 4 Openings	086876187274	192
FG917388	BEIG	45-Gallon Ranger® Container with 4 Openings	086876187281	192
FG917500	BLA	65-Gallon Ranger® Container with 2 Doors	086876187298	192
FG917500	BEIG	65-Gallon Ranger® Container with 2 Doors	086876187304	192
FG917600	BLA	65-Gallon Ranger® Container with 4 Openings	086876187311	192
FG917600	BEIG	65-Gallon Ranger® Container with 4 Openings	086876187328	192
FG917700	BLA	Weighted Base Accessory for 45 and 65 Gallon Ranger® Container	086876187335	192
FG917700	BEIG	Weighted Base Accessory for 45 and 65 Gallon Ranger® Container	086876187342	192
FG940600	PLAT	CaterMax™ 25 Insulated Single-Pan Carrier accommodates 1/1, 1/2, and 1/3 Food Pans	086876155075	274
FG940600	BLA	CaterMax™ 25 Insulated Single-Pan Carrier accommodates 1/1, 1/2, and 1/3 Food Pans		274
FG940700	PLAT	CaterMax™ 50 Insulated Four-Pan Carrier accommodates 1/1, 1/2, and 1/3 Food Pans	086876155082	274
FG940700	BLA	CaterMax™ 50 Insulated Four-Pan Carrier accommodates 1/1, 1/2, and 1/3 Food Pans		274
FG940800	PLAT	CaterMax™ 100 Insulated End-Load Pan Carrier accommodates 1/1, 1/2, and 1/3 Food Pans	086876156263	274
FG940800	BLA	CaterMax™ 100 Insulated End-Load Pan Carrier accommodates 1/1, 1/2, and 1/3 Food Pans		274
FG940888	PLAT	CaterMax™ 100 Insulated End-Load Pan Carrier with 5" (12.7 cm) Swivel Casters accommodates 1/1, 1/2, and 1/3 Food Pans		274
FG940888	BLA	CaterMax™ 100 Insulated End-Load Pan Carrier with 5" (12.7 cm) Swivel Casters accommodates 1/1, 1/2, and 1/3 Food Pans		274
FG950900	YEL	Stable Safety Sign with "Caution" Imprint, English, Spanish, French		242
FG993046	WTC	Milan Collection Pescara Ash/Trash		169
FG993047	WTC	Milan Collection Tuscan Um		169
FG993053	WTC	Milan Collection Tuscan Ash/Trash		169
FG980000	GRAY	Plastic Foam Block, Fine Floor Sweep, Flagged Polypropylene Fill	086876163872	87
FG980100	BLA	Plastic Foam Block, Fine Floor Sweep, Tampico Fill with Horsehair Border	086876163889	87
FG980200	GRAY	Plastic Foam Block, Fine Floor Sweep, Flagged Polypropylene Fill	086876163896	87
FG980300	BLA	Plastic Foam Block, Fine Floor Sweep, Tampico Fill with Horsehair Mix Border	086876163902	87
FG980400	GRAY	Hardwood Block, Fine Floor Sweep, Flagged Polypropylene Fill	086876163919	87
FG980500	BLA	Hardwood Block, Fine Floor Sweep, Tampico Fill with Horsehair Border	086876163926	87
FG980600	BLA	Plastic Foam Block, Medium Floor Sweep, Polypropylene Fill	086876163933	88

¹ FedEx shippable items.

* Contact Customer Service for UPC information not provided.

Part	Color	Description	UPC	Page
FG9B0700	BLA	Plastic Foam Block, Medium Floor Sweep, Tampico Fill	086876163940	88
FG9B0800	GRAY	Plastic Foam Block, Medium Floor Sweep, Multisurface, Polypropylene Fill, Flagged Border	086876163957	88
FG9B0900	BLA	Plastic Foam Block, Medium Floor Sweep, Polypropylene Fill	086876163964	88
FG9B1000	BLA	Plastic Foam Block, Medium Floor Sweep, Tampico Fill	086876163971	88
FG9B1100	GRAY	Plastic Foam Block, Medium Floor Sweep, Multisurface, Polypropylene Fill, Flagged Border	086876163988	88
FG9B1200	BLA	Hardwood Block, Medium Floor Sweep, Polypropylene Fill	086876163995	88
FG9B1300	BLA	Hardwood Block, Medium Floor Sweep, Tampico Fill	086876164008	88
FG9B1400	GRAY	Hardwood Block, Medium Floor Sweep, Multisurface, Polypropylene Fill, Flagged Border	086876164015	88
FG9B1500	MARN	Plastic Foam Block, Heavy-Duty Floor Sweep, Coarse Polypropylene and Polystyrene Fill		88
FG9B1600	BRN	Plastic Foam Block, Heavy-Duty Floor Sweep, Palmyra Fill	086876164039	88
FG9B1700	MARN	Plastic Foam Block, Heavy-Duty Floor Sweep, Coarse Polypropylene and Polystyrene Fill		88
FG9B1800	BRN	Plastic Foam Block, Heavy-Duty Floor Sweep, Palmyra Fill	086876164053	88
FG9B1900	MARN	Hardwood Block, Heavy-Duty Floor Sweep, Coarse Polypropylene and Polystyrene Fill		88
FG9B2000	BRN	Hardwood Block, Heavy-Duty Floor Sweep, Palmyra Fill	086876164077	88
FG9B2100	BRN	Street Broom, Hardwood Block, Polypropylene Fill	086876164084	89
FG9B2200	BRN	Street Broom, Hardwood Block, Palmyra Fill	086876164091	89
FG9B2300	YEL	Square Block Scrub Brush, Polypropylene Fill	086876164107	92
FG9B2400	BRN	Square Block Scrub Brush, Palmyra Fill	086876164114	92
FG9B2500	YEL	Pointed Scrub Brush, Tampico Fill	086876164121	92
FG9B2600	YEL	Pointed Scrub Brush, Polypropylene Fill	086876164138	92
FG9B2700	BLA	Curved Plastic Handle Counter Brush, Polypropylene Fill	086876164145	90
FG9B2800	BRN	Short Plastic Handle-Utility Brush, Palmyra Fill	086876164152	90
FG9B2900	YEL	Short Plastic Handle-Utility Brush, Synthetic Fill	086876164169	90
FG9B3000	YEL	Short Plastic Handle-Utility Brush, Tampico Fill	086876164176	90
FG9B3100	BRN	Long Plastic Handle-Utility Brush, Palmyra Fill	086876164183	90
FG9B3200	YEL	Long Plastic Handle-Utility Brush, Synthetic Fill	086876164190	90
FG9B3300	YEL	Long Plastic Handle-Utility Brush, Tampico Fill	086876164206	90
FG9B3400	BRN	Deck Brush, Plastic Block, Palmyra Fill	086876164213	91
FG9B3500	BRN	Deck Brush, Wood Block, with Squeegee, Palmyra Fill	086876164220	91
FG9B3600	YEL	Deck Brush, Plastic Block, Polypropylene Fill	086876164237	91
FG9B3700	GRAY	Wash Brush, Plastic Block, Flagged Polystyrene Fill	086876164244	91
FG9B3800	YEL	Wash Brush, Plastic Block, Tampico Fill	086876164268	91
FG9B3900	YEL	Wash Brush, Round Block, Tampico Fill	086876164275	91
FG9B4000	GRAY	Wire Brush, Plastic Angular Handle	086876164282	91
FG9B4100	GRAY	Wire Brush, Short Plastic Handle	086876164299	91
FG9B4200	GRAY	Wire Brush with Scraper, Short Angular Handle	086876164305	91
FG9B4300	GRAY	Wire Brush, Long Plastic Handle	086876164312	91
FG9B4400	GRAY	Wire Brush with Scraper, Long Plastic Handle	086876164329	91
FG9B4500	GRAY	Wire Brush, Plastic Butcher Block Handle	086876164336	91
FG9B4600	GRAY	Wire Brush, Broad Plastic Handle	086876164343	91
FG9B4700	GRAY	Stainless Steel Wire Brush, Short Plastic Handle	086876164350	91
FG9B4800	GRAY	Stainless Steel Wire Brush, Long Plastic Handle	086876164367	91
FG9B4900	YEL	Masonry Brush, Hardwood Handle, Tampico Fill	086876164374	91
FG9B5000	YEL	Masonry Brush, Plastic Foam Block Handle, Synthetic Fill	086876164381	91
FG9B5100	YEL	Plastic Acid Brush, Tampico and Synthetic Fill	086876164398	91
FG9B5200	BLUE	Plastic Handle Bowl Brush, Polypropylene Fill	086876164404	92
FG9B5500	YEL	Corn Whisk Broom	086876164411	90
FG9B5600	BLA	Tile and Grout Brush, Plastic Bristles	086876164428	92
FG9B5700	0000	Tile and Grout Brush, Brass Bristles	086876164435	91
FG9B5800	WHT	Plastic Hand and Nail Brush, Polypropylene Bristles	086876164442	92
FG9B5900	BLA	Extra-Large Dust Pan	086876164459	90
FG9B6000	BLA	Jumbo Dust Pan	086876164466	90
FG9B7100	0000	Wide-Angle Brace for Fine, Medium and Heavy-Duty Floor Sweeps	086876164503	88
FG9B7200	GRN	Wash Brush, Plastic Block, Nylon Fill	086876164251	91
FG9C0306	0000	Assembled Bottle and Spray Trigger		121
FG9C0400	0000	30"-42" (76.2 cm-106.6 cm) Lambswool Duster with Telescoping Plastic Handle	086876169102	58
FG9C2600	BLA	18" (45.7 cm) Standard Floor Squeegee	086876170450	93
FG9C2700	BLA	22" (55.9 cm) Standard Floor Squeegee	086876170467	93
FG9C2800	BLA	22" (55.9 cm) Heavy-Duty Floor Squeegee	086876170474	93
FG9C2900	BLA	30" (76.2 cm) Heavy-Duty Floor Squeegee	086876170481	93
FG9C3100	BLA	18" (45.7 cm) Straight Floor Squeegee	086876170702	93
FG9C3200	BLA	24" (61 cm) Straight Floor Squeegee	086876170719	93
FG9C3300	BLA	36" (91.4 cm) Straight Floor Squeegee	086876170726	93
FG9C3400	BLA	24" (61 cm) Curved Floor Squeegee	086876170733	93
FG9C3500	BLA	18" (45.7 cm) Replacement Blade for FG9C3100	086876170740	93
FG9C3600	BLA	24" (61 cm) Replacement Blade for FG9C3200	086876170757	93
FG9C3700	BLA	36" (91.4 cm) Replacement Blade for FG9C3300	086876170825	93

Part	Color	Description	UPC	Page
FG9C4100	BLA	18" (45.7 cm) Plastic Professional Squeegee with Black Dual Moss Rubber	086876170672	93
FG9C4200	BLA	18" (45.7 cm) Plastic Scrub and Dry Squeegee with Black Dual Moss Rubber	086876170818	93
FG9C4300	RED	18" (45.7 cm) Plastic Professional Squeegee with Red Dual Moss Neoprene	086876170825	93
FG9C4400	RED	18" (45.7 cm) Plastic Scrub and Dry Squeegee with Red Dual Moss Neoprene	086876170832	93
FG9C7300	BLA	Quiet Caster Dolly	086876179255	63
FG9C7400	YEL	Dirty Water Bucket for WaveBrake® Combos	086876176612	63
FG9C7400	RED	Dirty Water Bucket for WaveBrake® Combos		63
FG9C8301	0000	Fresh Apple SeBreeze® Odor Absorbing Gel	086876177138	16
FG9C8401	0000	Citrus Breeze SeBreeze® Odor Absorbing Gel	086876177022	16
FG9C8501	0000	Ocean Breeze SeBreeze® Odor Absorbing Gel	086876177039	16
FG9C8701	0000	Lavender Bouquet SeBreeze® Odor Absorbing Gel	086876177114	16
FG9C8801	0000	Neutral SeBreeze® Odor Absorbing Gel	086876177107	16
FG9C8901	0000	Variety PK: 2 ea Citrus, Ocean, Lavender SeBreeze® Odor Absorbing Gel	086876177084	16
FG9C9000	0000	SeBreeze® Portable Fan System	086876174595	16
FG9C9401	0000	Lemon-Lime SeBreeze® Odor Absorbing Gel	086876177053	16
FG9C9501	0000	Wintermint SeBreeze® Odor Absorbing Gel	086876177077	16
FG9C9701	0000	Cinnamon Spice SeBreeze® Odor Absorbing Gel	086876177060	16
FG9C9801	0000	Neutral SeBreeze® Odor Absorbing Gel	086876177121	16
FG9F0300	WHT	Space-Saving Square Container	086876165395	256
FG9F0400	WHT	Space-Saving Square Container	086876165401	256
FG9F0500	WHT	Space-Saving Square Container	086876165418	256
FG9F0600	WHT	Space-Saving Square Container	086876165425	256
FG9F0700	WHT	Space-Saving Square Container	086876165432	256
FG9F0800	WHT	Space-Saving Square Container	086876165449	256
FG9F0900	WHT	Space-Saving Square Container	086876165456	256
FG9F1200	CGRAY	ProServe® Insulated End-Load, Full-Pan Carrier, Small	086876166750	273
FG9F1300	CGRAY	ProServe® Insulated End-Load, Full-Pan Carrier, Medium	086876166767	273
FG9F1400	CGRAY	ProServe® Insulated End-Load, Full-Pan Carrier, Large	086876166774	273
FG9F1500	CGRAY	ProServe® Insulated Top-Load, Half-Pan Carrier	086876166781	273
FG9F1600	CGRAY	ProServe® Insulated Top-Load, Full-Pan Carrier	086876166798	273
FG9F1900	BLA	ProServe® Insulated Carrier Dolly with Retention Strap	086876166828	273
FG9F3500	RED	ProServe™ Pizza Delivery Bag, Small	086876172577	274
FG9F3600	RED	ProServe™ Pizza Delivery Bag, Medium	086876172584	274
FG9F3700	RED	ProServe™ Pizza Delivery Bag, Large	086876172591	274
FG9F3800	RED	ProServe™ Pizza/Catering/Sandwich Delivery Bag, Medium	086876172607	274
FG9F3900	RED	ProServe™ Pizza/Catering/Sandwich Delivery Bag, Large	086876172614	274
FG9F4000	RED	ProServe™ Sandwich Delivery Bag	086876172621	274
FG9F4300	0000	Scoop Holder	086876200362	272
FG9F5000	TBLUE	74-oz Scoop with Hand Guard	086876200348	272
FG9F5100	TBLUE	74-oz Scoop with Hand Guard and Holder	086876200355	272
FG9F5200	TBLUE	Scovel™ Two-Handled Shovel	086876200379	272
FG9F5300	TBLUE	Ice Tote	086876200386	272
FG9F5400	TBLUE	Ice Tote with Bin Hook Adapter	086876200393	272
FG9F5500	BLA	Ice Cart		272
FG9F5600	0000	Ice Bin Hook Adapter	086876200409	272
FG9F7300	BLA	Ice Tote Lid		272
FG9F7500	CLR	Bouncer® Contour Scoop for FG360088, FG360288, FG360388 Ingredient Bins and FG9G7700	086876176773	251
FG9F7500	CLR	Bouncer® Contour Scoop for FG360088, FG360288, FG360388 Ingredient Bins (32-oz. scoop)	086876176773	261
FG9F7600	CLR	Bouncer® Contour Scoop for FG360088, FG360288, FG360388 Ingredient Bins and FG9G7800	086876176780	251
FG9F7600	CLR	Bouncer® Contour Scoop for FG360088, FG360288, FG360388 Ingredient Bins (64-oz. scoop)	086876176780	261
FG9F7700	CLR	Sliding Lid with 32-oz (0.9-L) Scoop for FG360088 Ingredient Bin	086876176797	250
FG9F7800	CLR	Sliding Lid with 32-oz (0.9-L) Scoop for FG360288 Ingredient Bin	086876176803	250
FG9F7900	CLR	Sliding Lid with 32-oz (0.9-L) Scoop for FG360388 Ingredient Bin	086876176810	250
FG9F8600	WHT	"ICE ONLY" Container	086876173086	262
FG9F9000	CLR	Vinyl Rack Cover for FG9F9700, FG332000 Racks	086876169508	275
FG9F9700	BLA	ProServe™ Standard Base Sheet Pan Rack	086876166507	275
FG9G5100	CLR	Bouncer® Portioning Scoop for FG9G5700, FG9G5800 Shelf Ingredient Bins and FG9G7600, FG9G7300	086876183610	251
FG9G5100	CLR	Bouncer® Portioning Scoop – 2 Cup	086876183610	261
FG9G5200	CLR	Bouncer® Portioning Scoop for FG9G7700, FG9G7400 Sliding Lid	086876183627	251
FG9G5200	CLR	Bouncer® Portioning Scoop – 3 Cup	086876183627	261
FG9G5300	CLR	Bouncer® Portioning Scoop for FG9G7800, FG9G7500 Sliding Lid	086876183634	251
FG9G5300	CLR	Bouncer® Portioning Scoop – 4 Cup	086876183634	261

¹ FedEx shippable items.

* Contact Customer Service for UPC information not provided.

Part	Color	Description	UPC	Page
FG9G5400	CLR	Bouncer® Portioning Scoop – 8 Cup	086876183641	261
FG9G5700	WHT	100-Cup Shelf Ingredient Bin with 2-Cup Scoop	086876189957	250
FG9G5800	WHT	200-Cup Shelf Ingredient Bin with 2-Cup Scoop	086876189964	250
FG9G5900	CHRM	Cart for Shelf Ingredient Bins	086876189971	251
FG9G6000	WHT	40-Cup Shelf Ingredient Bin with 1/2-Cup Scoop		250
FG9G7300	WHT	Sliding Lid w/ 2-Cup Scoop and FG261000 BRUTE® Container COMBO		252
FG9G7400	WHT	Sliding Lid w/ 3-Cup Scoop and FG262000 BRUTE® Container COMBO		252
FG9G7500	WHT	Sliding Lid w/ 4-Cup Scoop and FG263200 BRUTE® Container COMBO		252
FG9G7600	WHT	Sliding Lid with 2-Cup Scoop (fits FG261000 BRUTE® Container)		252
FG9G7700	WHT	Sliding Lid with 3-Cup Scoop (fits FG262000 BRUTE® Container)		252
FG9G7800	WHT	Sliding Lid with 4-Cup Scoop (fits FG263200 BRUTE® Container)		252
FG9G7900	CHRM	Mobile Rack for Shelf Ingredient Bins, 38" wide		251
FG9G8000	CHRM	Mobile Rack for Shelf Ingredient Bins, 50" wide		251
FG9G8100	CHRM	Wall-Mounted Rack for Shelf Ingredient Bin (FG9G6000 only)		251
FG9G8200	WHT	1/2 Cup Measuring Scoop for FG9G6000 Shelf Ingredient Bin		251
FG9G8200	WHT	Measuring Scoop		260
FG9M0000	BLA	Lobby Pro® Wet/Dry Spill Pan	086876164589	94
FG9M0100	BLA	Lobby Pro® Wet/Dry Cleaning Wand	086876164596	94
FG9P9000	DGRN	Plaza® Jr. Container	086876167023	193
FG9P9000	BEIG	Plaza® Jr. Container	086876167030	193
FG9P9000	BLA	Plaza® Jr. Container	086876167047	193
FG9P9100	DGRN	Plaza® Jr. Container with Ashtray Top	086876167054	193
FG9P9100	BEIG	Plaza® Jr. Container with Ashtray Top	086876167061	193
FG9P9100	BLA	Plaza® Jr. Container with Ashtray Top	086876167078	193
FG9S0000	YEL	Pop-Up Safety Cone, 20" (50.8 cm) with Multilingual "Caution" Imprint and Wet Floor Symbol	086876165951	244
FG9S0100	YEL	Pop-Up Safety Cone, 30" (76.2 cm) with Multilingual "Caution" Imprint and Wet Floor Symbol	086876165968	244
FG9S0700	YEL	Folding Safety Cone with "Caution" Imprint, English, Spanish, French	086876173345	244
FG9S0725	YEL	Folding Safety Cone with International Wet Floor Symbol	086876173352	244
FG9S0925	YEL	Stable Safety Sign with International Wet Floor Symbol	086876173314	242
FG9S1100	YEL	Mobile Barrier	086876166729	243
FG9S1500	YEL	Site Safety Hanging Sign with "Closed for Cleaning" Imprint – English Only	086876166590	245
FG9S1600	YEL	Site Safety Hanging Sign with Multilingual "Closed for Cleaning" Imprint	086876166606	245
FG9S3000	GRAY	BRUTE® Tote with Lid	086876166156	236
FG9S3000	WHT	BRUTE® Tote with Lid		236
FG9S3100	GRAY	BRUTE® Tote with Lid	086876166187	236
FG9S3100	WHT	BRUTE® Tote with Lid		236
FG9T0000	PLAT	Protective Security Hood for Classic Housekeeping Carts	086876164763	107
FG9T0000	BLA	Protective Security Hood for Classic Housekeeping Carts		107
FG9T0100	BRN	Refuse Cover for 618900, 619000, 619100, 619200, 9T1900 Carts	086876164770	107
FG9T0400	BRN	Executive Canvas Linen Accessory Bag for 618900, 619000, 619100, 619200, 9T1900 Carts	086876164800	107
FG9T0600	BLA	5th Wheel Wagon Truck with 16" (40.6 cm) Pneumatic Wheels	086876184631	214
FG9T0700	BLA	5th Wheel Wagon Truck with 12" (30.5 cm) Pneumatic Wheels	086876184648	214
FG9T0900	BLA	Side Panel Package, fits FG9T1100, FG9T1200, FG9T2100 (4 sides and 2 end panels)	086876184594	210
FG9T0900	BLA	Side Panel Package, Converts Truck to Platform Convertible Wagon (4 sides and 2 end panels), fits FG9T0600, FG9T0700	086876184594	214
FG9T1000	0000	Tow Package, fits all 5th Wheel Wagon Trucks	086876164664	214
FG9T1100	BLA	Heavy-Duty Platform Truck	086876184600	210
FG9T1200	BLA	Heavy-Duty Platform Truck	086876184617	210
FG9T1300	BLA	Structural Foam Tilt Truck, Utility-Duty	086876184167	231
FG9T1400	BLA	Structural Foam Tilt Truck, Standard-Duty	086876184174	231
FG9T1500	BLA	Structural Foam Tilt Truck, Standard-Duty	086876184204	231
FG9T1600	BLA	Structural Foam Tilt Truck, Heavy-Duty	086876184211	231
FG9T1700	BLA	Tilt Truck (RM)	086876165593	232
FG9T1800	BLA	Tilt Truck	086876165609	232
FG9T1900	BLA	Full-Size Housekeeping Cart with Doors	086876192445	106
FG9T2100	BLA	Heavy-Duty Platform Truck	086876184624	210
FG9T2200	BLA	Lid for FG9T1300 and FG9T1400 Tilt Trucks	086876184228	231
FG9T2300	BLA	Lid for FG9T1500 and FG9T1600 Tilt Trucks	086876184242	231
FG9T2800	BLA	Audio-Visual Cart, Open Cart with 3 Shelves, 3" dia (7.6 cm) Casters	086876165616	228
FG9T2900	BLA	Audio-Visual Cart, 3 Shelves with Cabinet, 3" dia (7.6 cm) Casters	086876165623	228
FG9T3000	BLA	Audio-Visual Cart, Open Cart with 3 Shelves, 4" dia (10.2 cm) Casters	086876165630	228

Part	Color	Description	UPC	Page
FG9T3200	BLA	Audio-Visual Cart, 3 Shelves with Cabinet, 4" dia (10.2 cm) Casters	086876165654	228
FG9T3300	BLA	Audio-Visual Cart, Open Cart with 3 Shelves, 4" dia (10.2 cm) Casters	086876165661	228
FG9T3400	BLA	Audio-Visual Cart, 3 Shelves with Cabinet, 4" dia (10.2 cm) Casters	086876165678	228
FG9T3500	BLA	Audio-Visual Cart, 4 Shelves with Cabinet, 4" dia (10.2 cm) Casters	086876165685	228
FG9T3600	BLA	Shelving, 4-Shelf Unit	086876165692	228
FG9T3700	BLA	Shelving, 5-Shelf Unit	086876165708	228
FG9T3800	BLA	Shelving, 4-Shelf Unit	086876165715	228
FG9T3900	BLA	Shelving, 5-Shelf Unit	086876165722	228
FG9T4000	BLA	Shelving, 6-Shelf Unit	086876165739	228
FG9T4200	BLA	Mobile Shelf Truck, 5-Shelf Mobile Truck with 5" dia (12.7 cm) Casters, 2 with Locks	086876165753	228
FG9T4300	BLA	Mobile Shelf Truck, 4-Shelf Mobile Truck with 5" dia (12.7 cm) Casters, 2 with Locks	086876165760	228
FG9T4500	BLA	StockMate® ES Restocking Truck with Hinged Deck	086876165906	218
FG9T4800	BLA	StockMate® Wire Shelf	086876165937	218
FG9T5000	BLA	StockMate® Restocking Truck, Standard Deck	086876165890	218
FG9T5200	BLA	StockMate® Restocking Truck, Standard Deck with Cardboard Management System, Polyurethane Wheels and Casters	086876172355	218
FG9T5400	RED	Polyethylene Dolly, Flush Deck	086876167436	218
FG9T5500	RED	Polyethylene Dolly, Padded Deck	086876167443	218
FG9T5600	BLA	StockMate® Restocking Truck, Utility Deck, Olefin Wheels and Casters	086876172393	218
FG9T5700	BLA	Ladder Cart	086876176377	221
FG9T5800	BLA	Ladder Cart with Cabinet	086876176384	221
FG9T5900	BLA	Executive Series™ Cruise Housekeeping Cart	086876193282	105
FG9T6000	BLA	Executive Series™ Compact Housekeeping Cart	086876193299	105
FG9T6100	BLA	Executive Series™ Deluxe Compact Housekeeping Cart	086876193305	105
FG9T6200	BLA	Executive Series™ High-Capacity Housekeeping Cart	086876193312	105
FG9T6300	BLA	Executive Series™ Deluxe High-Capacity Housekeeping Cart	086876193329	105
FG9T6400	BLA	Deluxe High-Security Housekeeping Cart	086876193336	105
FG9T6571	BEIG	Utility Cart with 3" dia (7.6 cm) Swivel Casters	086876173802	226
FG9T6600	BLA	2 Shelf Utility Cart, w/ 5" Casters	086876175080	223
FG9T6700	BLA	2 Shelf Utility Cart, w/ 5" Casters	086876175097	223
FG9T6800	BLA	Executive Service Cart	086876200447	225, 277
FG9T6800	PLAT	Executive Service Cart	086876200454	225, 277
FG9T7200	BLA	High-Capacity Cleaning Cart	086876180572	99
FG9T7300	BLA	Microfiber Cleaning Cart	086876180589	98
FG9T7301	0000	Lock 'N Go Accessory	086876188363	99
FG9T7400	BLA	Microfiber Cleaning Cart with Color-Coded Pails	086876180596	98
FG9T7500	BLA	High-Security Cleaning Cart	086876180602	98
FG9T7600	BLA	Executive Series™ Compact Folding Housekeeping Cart	086876180619	101
FG9T7700	BLA	Executive Series™ Turndown Housekeeping Cart	086876180626	101
FG9T7800	BLA	Executive Series™ High-Security Housekeeping Cart	086876180633	101
FG9T7900	BLA	Double-Capacity Cleaning Cart	086876185188	99
FG9T8000	YEL	High-Capacity Vinyl Replacement Bag	086876180640	100, 102
FG9T8100	BLA	Compact Fabric Replacement Bag	086876180657	100, 102
FG9T8100	BLA	Compact Fabric Replacement Bag	086876180657	102
FG9T8200	BLA	10-Quart Sanitizing Caddy	086876180671	107
FG9T8301		4-Pack of 5-Quart Disinfecting Pail – Blue, Red, Yellow, Green	086876180688	102
FG9T8400	YEL	30-Quart Organizing Bins	086876180695	102
FG9T8400	BLA	30-Quart Organizing Bins	086876187434	102
FG9T8500	BLA	Locking Cabinet Door Kit	086876180701	103
FG9T8600	BLA	Preassembled Locking Security Hood	086876180718	103
FG9T8701	RED	4" Quiet Caster Kit (2)	086876180732	103
FG9T8901	0000	Triple Waste Wire Bag Holders	086876182002	102
FG9T9000	BLA	Executive Series™ Fabric 9-Pocket Organizer	086876182101	102, 107
FG9T9101	BLA	Fabric Mesh Linen Bag	086876182118	102, 107
FG9T9101	BLA	Easy Side-Load Linen Bag	086876182118	105
FG9T9200	BLA	Triple-Capacity Cleaning Cart	086876187946	100
FG9T9300	RED	Recycling Bag with Universal Recycling Symbol	086876187953	100, 102
FG9T9300	GRN	Recycling Bag with Universal Recycling Symbol	086876187991	100, 102
FG9T9300	BLU	Recycling Bag with Universal Recycling Symbol	086876188004	100, 102
FG9T9300	BLU	Recycling Bag with Universal Recycling Symbol	086876188004	102
FG9T9301	0000	Recycling Bag with Universal Recycling Symbol – Set of 3 Colors (Red, Green, Blue)	086876188370	100, 102
FG9T9400BLA	WOOD-GRAIN	Executive Series™ Deluxe Paneled Compact Housekeeping Cart	086876191547	101
FG9T9500BLA	WOOD-GRAIN	Executive Series™ Deluxe Paneled Housekeeping Cart	086876191554	101
FG9T9600	MAHG	Deluxe Paneled Housekeeping Cart Locking Cabinet Door Kit	086876191561	101, 103
FG9VBH10	0000	Executive Series™ 10-Qt Capacity HEPA Backpack Vacuum Cleaner	086876193770	110
FG9VBHHP10		Replacement HEPA Exhaust Filter for FG9VBH10 and 1868435	086876190984	111
FG9VBP06	0000	Executive Series™ 6-Qt Capacity Backpack Vacuum Cleaner	086876193725	110

¹ FedEx shippable items.

* Contact Customer Service for UPC information not provided.

Part	Color	Description	UPC	Page
FG9VBP10	0000	Executive Series™ 10-Qt Capacity Backpack Vacuum Cleaner		110
FG9VBPBA06		Replacement Cloth Bag for FG9VBP06 and 1868433	086876191240	111
FG9VBPBA10		Replacement Cloth Bag for FG9VBP10, 1868434, FG9VBH10, and 1868435	086876193749	111
FG9VBPEB06		Belt Extender for Backpack Vacuum	086876200829	111
FG9VBPEF06		Replacement Exhaust Filter and Sound Diffuser and Foam Intake Filter for FG9VBP06, 1868433, FG9VBP10, and 1868434	086876191257	111
FG9VBPHA06		Replacement Backpack Harness for Backpack Vacuum	086876191264	111
FG9VBPHP06		HEPA Bag for FG9VBH10 and 1868435	086876193244	111
FG9VBPHS06		Replacement Cleaner Hose for Backpack Vacuum	086876191943	111
FG9VBPPB06		Replacement Paper Bag for FG9VBP06 and 1868433	086876191230	111
FG9VBPPB10		Replacement Paper Bag for FG9VBP10, 1868434, FG9VBH10, and 1868435	086876193732	111
FG9VCV12	0000	12" Traditional Upright Vacuum Cleaner	086876190892	113
FG9VCV16	0000	16" Traditional Upright Vacuum Cleaner	086876190908	113
FG9VCVBA12		Replacement Cloth Dust Bag with Dust Tube for FG9VCV12, 1868436, FG9VCV16, and 1868437	086876191028	114
FG9VCVBE12		Replacement Round Belt for FG9VCV12, 1868436, FG9VCV16, and 1868437	086876191011	114
FG9VCVBR12		Replacement Brush Roll for FG9VCV12 and 1868436	086876190991	114
FG9VCVBR16		Replacement Brush Roll for FG9VCV16 and 1868437	086876191004	114
FG9VCVPB12		Replacement Paper Bag for FG9VCV12, 1868436, FG9VCV16, and 1868437		114
FG9VCVSB12		Shake-Out Bags for FG9VCV12, 1868436, FG9VCV16, and 1868437		114
FG9VDVEF44		Replacement Exhaust Filter (10-pack)		117
FG9VDVHP10		Replacement HEPA Bags (10-pack)		117
FG9VDVPB10		Replacement Paper Bags (10-pack)		117
FG9VDVPN12		Replacement Power Nozzle for DVAC (base not included)	086876205565	117
FG9VDVPA400	YEL	Power Nozzle Model w/ Deluxe Rim Caddy		117
FG9VDVPA400	BLA	Power Nozzle Model w/ Deluxe Rim Caddy		117
FG9VDVRC4400	YEL	Deluxe Rim Caddy (fits BRUTE® 44-Gallon only)		117
FG9VDVSS4400	YEL	DVAC Straight Suction Vacuum Cleaner		117
FG9VMH12	0000	12" Manual-Height Upright Vacuum Cleaner	086876190922	112
FG9VMH15	0000	15" Manual-Height Upright Vacuum Cleaner	086876190939	112
FG9VMHBA12		Replacement Paper Bag for Dual-Motor and Manual-Height Upright Vacuums	086876191165	114
FG9VMHBA12		Replacement Paper Bag for FG9VPH12, 1868438, FG9VPH15, 1868439, FG9VMH12, 1868440, FG9VMH15, and 1868621	086876191165	114
FG9VMHBE12		Replacement Brush Belt for FG9VMH12, 1868438, FG9VMH15, and 1868439	086876191141	114
FG9VMHBL12		Replacement Motor Belt for FG9VMH12, 1868438, FG9VMH15, and 1868439	086876191530	114
FG9VMHBR12		Replacement Brush Roll for FG9VMH12 and 1868438	086876191073	114
FG9VMHBR15		Replacement Brush Roll for FG9VMH15 and 1868439	086876191097	114
FG9VMHEF12		Replacement Exhaust Filter for FG9VMH12, 1868438, FG9VMH15, and 1868439	086876191080	114
FG9VMHHP		HEPA Filter Kit for FG9VPH12, 1868438, FG9VPH15, 1868439, FG 9VMH12, 1868440, FG9VMH15, and 1868621 (8 bags & 1 filter)	086876191158	114
FG9VMHMF12		Replacement Air Filter for FG9VPH12, 1868438, FG9VPH15, 1868439, FG 9VMH12, 1868440, FG9VMH15, and 1868621	086876191103	114
FG9VPH12	0000	12" Power-Height Upright Vacuum Cleaner	086876190946	112
FG9VPH15	0000	15" Power-Height Upright Vacuum Cleaner	086876190953	112
FG9VPHBE12		Replacement Timing Belt for FG9VMH12, 1868438, FG9VMH15, and 1868439	086876191172	114
FG9VPHBR12		Replacement Brush Roll for FG9VPH12 and 1868438		114
FG9VPHBR15		Replacement Brush Roll for FG9VPH15 and 1868439		114
FG9VPHFE12		Replacement Exhaust Filter for FG9VMH12, 1868438, FG9VMH15, and 1868439	086876191394	114
FG9VUL12	0000	12" Ultra-Light Upright Vacuum Cleaner	086876190915	113
FG9VULBC12		Replacement Cloth Bag for FG9VUL12 and 1868622	086876191035	114
FG9VULBE12		Replacement Belt for FG9VUL12 and 1868622	086876191059	114
FG9VULBR12		Replacement Brush Roll for FG9VUL12 and 1868622	086876191042	114
FG9VULPB12		Replacement Paper Bag for FG9VUL12 and 1868622	086876191066	114
FG9VWD12	0000	12.5-Gal Capacity Wet and Dry Vacuum Cleaner	086876190960	115
FG9VWD16	0000	16-Gal Capacity Wet and Dry Vacuum Cleaner	086876190977	115
FG9VWDF12		Replacement Foam Filter for FG9VWD12 and FG9VWD16 (1 large and 1 small)	086876191288	115
FG9VWDHS12		Replacement Cleaner Hose for FG9VWD12 and FG9VWD16	086876193824	115
FG9VWDPF12		Replacement HEPA Pleated Filter for FG9VWD12 and FG9VWD16 (with foam sleeves)	086876191271	115

¹ FedEx shippable items.

Part	Color	Description	UPC	Page
FG9W0000	BLA	Landmark Series® Standard Funnel Top	086876166880	196
FG9W0100	BLA	Landmark Series® Standard Dome Top	086876166897	196
FG9W0200	BLA	Landmark Series® Funnel Top with Panel Frame and 3958 Rigid Liner	086876166903	196
FG9W0300	BLA	Landmark Series® Dome Top with Panel Frame and 3958 Rigid Liner	086876166910	196
FG9W0400	BLA	Window Wash Kit for FG9W0000, FG9W0100, FG9W0200, FG9W0300 Containers	086876166927	196
FG9W0500	CMARB	Decorative Panels for FG9W0200, FG9W0300 Containers	086876166934	196
FG9W0500	SGRAY	Decorative Panels for FG9W0200, FG9W0300 Containers		196
FG9W0600	BLA	Pole/Wall-Mount Kit for Window Wash Unit		196
FG9W1088	GRAY	BRUTE® Confidential Document Rollout Container	086876166965	133, 147
FG9W1188	GRAY	BRUTE® Confidential Document Rollout Container	088761688224	133, 147
FG9W1200	BLA	Light-Duty Container Base	086876166101	196
FG9W1300	BLA	Light-Duty Container Lid for FG9W1200, FG263200 Containers	086876166118	129, 196
FG9W1300	GRAY	Light-Duty Container Lid for FG9W1200, FG263200 Containers		196
FG9W1400	BLA	Light-Duty Container Combo, Contains (1) FG9W1200 and (1) FG9W1300	086876166125	196
FG9W1500	LGRAY	Slim Jim® Confidential Document Container with Lid	086876166132	147
FG9W1600	LGRAY	Slim Jim® Confidential Document Container Lids for FG354000, FG354100 Containers	086876166149	147
FG9W1700	LPLAT	Metal Confidential Document Container with Confidential Document Bag	086876166576	147
FG9W1900	RED	BRUTE® Medical Waste Rollout Container	086876168785	133
FG9W2000	RED	BRUTE® Medical Waste Rollout Container	086876169041	133
FG9W2100	GRAY	BRUTE® Rollout Container with Lid	086876168792	133
FG9W2173	BLUE	BRUTE® Rollout Container with Lid	086876194326	133
FG9W2200	GRAY	BRUTE® Rollout Container with Lid	086876169058	133
FG9W2273	BLUE	BRUTE® Rollout Container with Lid	086876169065	133
FG9W2500	LGRAY	Slim Jim® Confidential Document Container with Handles and Lid	086876167603	147
FG9W2700	GRAY	BRUTE® Rollout Container with Lid	086876175387	133
FG9W2700	BLUE	BRUTE® Rollout Container with Lid	086876176636	133
FG9W2700	YEL	BRUTE® Rollout Container with Lid	086876176643	133
FG9W2773	BLUE	BRUTE® Recycling Rollout Container with Lid	086876176643	133
FG9W2900	0000	Security Kit for GroundsKeeper® Tuscan Receptacle	086876173130	200
FG9W3000	SSTON	GroundsKeeper® Tuscan Receptacle	086876173048	200
FG9W3000	BLA	GroundsKeeper® Tuscan Receptacle	086876173055	200
FG9W3100	SSBLA	Infinity™ Base-Mount Smoking Receptacle	086876183450	199
FG9W3101	SSSTL	Infinity™ Base-Mount Stainless Replacement Canister	086876184945	199
FG9W3200	SSBLA	Infinity™ Wall-Mount Smoking Receptacle	086876183467	199
FG9W3201	SSSTL	Infinity™ Wall-Mount Stainless Replacement Canister	086876184975	199
FG9W3300	BLA	Infinity™ Traditional Smoking Receptacle	086876183474	199
FG9W3300	AGBRNZ	Infinity™ Traditional Smoking Receptacle	086876183481	199
FG9W3300	ATPWTR	Infinity™ Traditional Smoking Receptacle	086876183498	199
FG9W3301	SILV	Infinity™ Traditional Galvanized Replacement Bucket	086876184990	199
FG9W3400	BLA	Infinity™ Ultra-High-Capacity Smoking Receptacle	086876183504	199
FG9W3400	AGBRNZ	Infinity™ Ultra-High-Capacity Smoking Receptacle	086876183511	199
FG9W3400	ATPWTR	Infinity™ Ultra-High-Capacity Smoking Receptacle	086876183528	199
FG9W3700	BLA	Square Funnel Top Frame	086876176001	183
FG9W3800	BLA	Square Dome Top Frame	086876176018	183
FG9W4200	BLA	Round Funnel Top Frame	086876176025	183
FG9W4400	BLA	Round Dome Top Frame	086876176032	183
FG9W5000	BRNZ	35-Gal Perforated Square Panel Kit	086876176049	183
FG9W5000	DGRN	35-Gal Perforated Square Panel Kit	086876176056	183
FG9W5000	SILV	35-Gal Perforated Square Panel Kit	086876176063	183
FG9W5100	BRNZ	50-Gal Perforated Square Panel Kit	086876176070	183
FG9W5100	DGRN	50-Gal Perforated Square Panel Kit	086876176087	183
FG9W5100	SILV	50-Gal Perforated Square Panel Kit	086876176094	183
FG9W5400	BRNZ	32-Gal Perforated Round Panel Kit	086876176100	183
FG9W5400	DGRN	32-Gal Perforated Round Panel Kit	086876176117	183
FG9W5400	SILV	32-Gal Perforated Round Panel Kit	086876176124	183
FG9W5500	BRNZ	35-Gal Solid Square Panel Kit	086876176162	183
FG9W5500	DGRN	35-Gal Solid Square Panel Kit	086876176162	183
FG9W5600	BRNZ	50-Gal Solid Square Panel Kit	086876176193	183
FG9W5600	DGRN	50-Gal Solid Square Panel Kit	086876176223	183
FG9W5900	BRNZ	32-Gal Solid Round Panel Kit	086876176223	183
FG9W5900	DGRN	32-Gal Solid Round Panel Kit		183
FG9W6288	BLA	32-Gal Round Liner		183
FG9W6300	BLA	35-Gal Rigid Liner		183
FG9W6400	BLA	50-Gal Rigid Liner		183
FG9W7100	BLA	Mega BRUTE® Mobile Waste Collector – 3-Pack		132
FG9W7200	BLA	Mega BRUTE® Lid		132
FG9W7300	BLA	Mega BRUTE® Mobile Waste Collector – 1-Pack		132
FG9W8700	YEL	BRUTE® Rim Caddy for FG264300 Containers		131
FGA012R		Mechanical Portion Control Scale – Dual-Read		267

* Contact Customer Service for UPC information not provided.

Part	Color	Description	UPC	Page
FGA11106	WH00	Web Foot® Wet Mop	086876090161	67
FGA11106	GR00	Web Foot® Wet Mop	086876090178	67
FGA11106	BL00	Web Foot® Wet Mop	086876090185	67
FGA11106	OR00	Web Foot® Wet Mop	086876090192	67
FGA11206	WH00	Web Foot® Wet Mop	086876090437	67
FGA11206	GR00	Web Foot® Wet Mop	086876090444	67
FGA11206	BL00	Web Foot® Wet Mop	086876090451	67
FGA11206	OR00	Web Foot® Wet Mop	086876090468	67
FGA11306	WH00	Web Foot® Wet Mop	086876090697	67
FGA11306	GR00	Web Foot® Wet Mop	086876090703	67
FGA11306	BL00	Web Foot® Wet Mop	086876090710	67
FGA11306	OR00	Web Foot® Wet Mop	086876090727	67
FGA12R		Mechanical Portion Control Scale – Dual-Read		267
FGA15106	WH00	Web Foot® Wet Mop	086876091250	67
FGA15106	GR00	Web Foot® Wet Mop	086876091267	67
FGA15106	BL00	Web Foot® Wet Mop	086876091274	67
FGA15106	OR00	Web Foot® Wet Mop	086876091281	67
FGA15206	WH00	Web Foot® Wet Mop	086876091533	67
FGA15206	GR00	Web Foot® Wet Mop	086876091540	67
FGA15206	BL00	Web Foot® Wet Mop	086876091557	67
FGA15206	OR00	Web Foot® Wet Mop	086876091564	67
FGA15306	WH00	Web Foot® Wet Mop	086876091816	67
FGA15306	BL00	Web Foot® Wet Mop	086876091830	67
FGA15306	OR00	Web Foot® Wet Mop	086876091847	67
FGA15306	GR00	Web Foot® Wet Mop	086876145168	67
FGA17	BK	Architek® Radius Top	097591102183	181
FGA17	ABZ	Architek® Radius Top	097591102190	181
FGA175U	BK	Architek® Radius Urn Top	097591102206	181
FGA175U	ABZ	Architek® Radius Urn Top	097591102213	181
FGA21106	WH00	Web Foot® Shrinkless® Wet Mop	086876055238	67
FGA21106	GR00	Web Foot® Shrinkless® Wet Mop	086876092349	67
FGA21106	BL00	Web Foot® Shrinkless® Wet Mop	086876092356	67
FGA21206	WH00	Web Foot® Shrinkless® Wet Mop	086876055252	67
FGA21206	GR00	Web Foot® Shrinkless® Wet Mop	086876055429	67
FGA21206	BL00	Web Foot® Shrinkless® Wet Mop	086876092516	67
FGA21306	WH00	Web Foot® Shrinkless® Wet Mop	086876055276	67
FGA21306	BL00	Web Foot® Shrinkless® Wet Mop	086876092660	67
FGA21306	GR00	Web Foot® Shrinkless® Wet Mop	086876145175	67
FGA22R		Mechanical Portion Control Scale – Dual Read		267
FGA25106	WH00	Web Foot® Shrinkless® Wet Mop	086876092974	67
FGA25106	GR00	Web Foot® Shrinkless® Wet Mop	086876092981	67
FGA25106	BL00	Web Foot® Shrinkless® Wet Mop	086876092998	67
FGA25106	OR00	Web Foot® Shrinkless® Wet Mop	086876145182	67
FGA25206	WH00	Web Foot® Shrinkless® Wet Mop	086876093124	67
FGA25206	GR00	Web Foot® Shrinkless® Wet Mop	086876093131	67
FGA25206	BL00	Web Foot® Shrinkless® Wet Mop	086876093148	67
FGA25206	OR00	Web Foot® Shrinkless® Wet Mop	086876093155	67
FGA25306	WH00	Web Foot® Shrinkless® Wet Mop	086876055344	67
FGA25306	GR00	Web Foot® Shrinkless® Wet Mop	086876093247	67
FGA25306	BL00	Web Foot® Shrinkless® Wet Mop	086876093254	67
FGA25306	OR00	Web Foot® Shrinkless® Wet Mop	086876145199	67
FGA38	ABZ	Architek® Canopy Top	097591102053	181
FGA38	BK	Architek® Canopy Top	097591102152	181
FGA38SD	BK	Architek® Canopy Top with Side Door	097591108963	181
FGA38SD	ABZ	Architek® Canopy Top with Side Door	097591109069	181
FGA385U	BK	Architek® Canopy Top with Urn	097591102060	181
FGA385U	ABZ	Architek® Canopy Top with Urn	097591102077	181
FGA38T	BK	Architek® Drop-In Top	097591102084	181
FGA38T	ABZ	Architek® Drop-In Top	097591102091	181
FGA38TSD	BK	Architek® Drop-In Top with Side Door	097591109250	181
FGA38TSD	ABZ	Architek® Drop-In Top with Side Door	097591109267	181
FGA41206	WH00	Web Foot® Finish Mop		67
FGA41306	WH00	Web Foot® Finish Mop		67
FGA505U	BK	Architek® Urn	097591102640	181
FGA505U	ABZ	Architek® Urn	097591102657	181
FGA515U	BK	Architek® Radius Urn Top	097591102527	181
FGA515U	ABZ	Architek® Radius Urn Top	097591102534	181
FGA81206	GR00	Web Foot® Microfiber String Mop		66
FGA81306	GR00	Web Foot® Microfiber String Mop		66
FGA85206	GR00	Web Foot® Microfiber String Mop		66
FGA85306	GR00	Web Foot® Microfiber String Mop		66
FGAOT15	BK	Crowne Collection Open-Top		162
FGAOT15	SAB	Crowne Collection Open-Top		162
FGAOT15	SAGR	Crowne Collection Open-Top		162
FGAOT15	SBBR	Crowne Collection Open-Top		162
FGAOT15	SA,	Crowne Collection Open-Top		162
FGAOT15	SB	Crowne Collection Open-Top		162
FGAOT30	BK	Crowne Collection Open-Top		162
FGAOT30	SABK	Crowne Collection Open-Top		162
FGAOT30	SAGR	Crowne Collection Open-Top		162
FGAOT30	SBBR	Crowne Collection Open-Top		162
FGAOT30	SA	Crowne Collection Open-Top		162
FGAOT30	SB	Crowne Collection Open-Top		162
FGAOT35	SA	Atrium® Aluminum Container Open-Top		161
FGAOT35	SB	Atrium® Aluminum Container Open-Top		161
FGAOT62	SA	Atrium® Aluminum Container Open-Top		161
FGAOT62	SB	Atrium® Aluminum Container Open-Top		161
FGATF18	SA	Atrium® Aluminum Container Flip-Top		161

Part	Color	Description	UPC	Page
FGATF18	SB	Atrium® Aluminum Container Flip-Top		161
FGB1414	SS	WasteMaster Open Top – Clean Room		146
FGB1424	SS	WasteMaster Open Top – Clean Room		146
FGB1940	SS	WasteMaster Open Top – Clean Room		146
FGB168S		Baker's Scale Stainless Steel Scoop (20-lb capacity)		265
FGB25	Black	Sand (5 x 5 lbs)		191
FGBBT1529	AL	Steel Wastebasket Dome Top for FGWB44 or FGWB209		145
FGBBT1529	BK	Steel Wastebasket Dome Top for FGWB44 or FGWB209		145
FGBBT1529	GR	Steel Wastebasket Dome Top for FGWB44 or FGWB209		145
FGBC1		Adjustable Counterweight (for use with FGB168S)		265
FGBD165C		Baker's Beam Scale		265
FGBD85C		Baker's Beam Scale		265
FGBW1		1-lb weight for Baker's Scale		265
FGBW2		2-lb weight for Baker's Scale		265
FGBW4		4-lb weight for Baker's Scale		265
FGC11106	GR00	Swinger Loop® Wet Mop	086876057676	68
FGC11106	WH00	Swinger Loop® Wet Mop	086876057676	68
FGC11106	BL00	Swinger Loop® Wet Mop	086876057676	68
FGC11206	GR00	Swinger Loop® Wet Mop	086876057928	68
FGC11206	WH00	Swinger Loop® Wet Mop	086876057928	68
FGC11206	BL00	Swinger Loop® Wet Mop	086876057928	68
FGC11306	GR00	Swinger Loop® Wet Mop	086876058161	68
FGC11306	WH00	Swinger Loop® Wet Mop	086876058161	68
FGC11306	BL00	Swinger Loop® Wet Mop	086876058161	68
FGC11406	WH00	Swinger Loop® Wet Mop	086876058390	68
FGC11406	GR00	Swinger Loop® Wet Mop	086876058406	68
FGC11406	BL00	Swinger Loop® Wet Mop	0868761452005	68
FGC15106	WH00	Swinger Loop® Wet Mop	086876058635	68
FGC15106	GR00	Swinger Loop® Wet Mop	086876058642	68
FGC15106	BL00	Swinger Loop® Wet Mop	086876058659	68
FGC15206	GR00	Swinger Loop® Wet Mop	086876058888	68
FGC15206	BL00	Swinger Loop® Wet Mop	086876058895	68
FGC15206	WH00	Swinger Loop® Wet Mop	086876145212	68
FGC15306	WH00	Swinger Loop® Wet Mop	086876059113	68
FGC15306	GR00	Swinger Loop® Wet Mop	086876059120	68
FGC15306	BL00	Swinger Loop® Wet Mop	086876059137	68
FGC15406	WH00	Swinger Loop® Wet Mop	086876059359	68
FGC15406	GR00	Swinger Loop® Wet Mop	086876059366	68
FGC15406	BL00	Swinger Loop® Wet Mop	086876059373	68
FGC21106	WH00	Swinger Loop® Shrinkless Wet Mop	086876059595	68
FGC21106	GR00	Swinger Loop® Shrinkless Wet Mop	086876059601	68
FGC21106	BL00	Swinger Loop® Shrinkless Wet Mop	086876059618	68
FGC21106	OR00	Swinger Loop® Shrinkless Wet Mop	086876171495	68
FGC21206	OR00	Swinger Loop® Shrinkless Wet Mop	086876171594	68
FGC21206	WH00	Swinger Loop® Shrinkless Wet Mop	086876059830	68
FGC21206	GR00	Swinger Loop® Shrinkless Wet Mop	086876059847	68
FGC21206	BL00	Swinger Loop® Shrinkless Wet Mop	086876059854	68
FGC21306	WH00	Swinger Loop® Shrinkless Wet Mop	086876060072	68
FGC21306	GR00	Swinger Loop® Shrinkless Wet Mop	086876060089	68
FGC21306	BL00	Swinger Loop® Shrinkless Wet Mop	086876060096	68
FGC21306	OR00	Swinger Loop® Shrinkless Wet Mop	086876171600	68
FGC25106	GR00	Swinger Loop® Shrinkless Wet Mop	086876060560	68
FGC25106	BL00	Swinger Loop® Shrinkless Wet Mop	086876060577	68
FGC25106	WH00	Swinger Loop® Shrinkless Wet Mop	086876145229	68
FGC25106	OR00	Swinger Loop® Shrinkless Wet Mop	086876171617	68
FGC25206	WH00	Swinger Loop® Shrinkless Wet Mop	086876060799	68
FGC25206	GR00	Swinger Loop® Shrinkless Wet Mop	086876060805	68
FGC25206	BL00	Swinger Loop® Shrinkless Wet Mop	086876060812	68
FGC25206	OR00	Swinger Loop® Shrinkless Wet Mop	086876171501	68
FGC25306	WH00	Swinger Loop® Shrinkless Wet Mop	086876061031	68
FGC25306	GR00	Swinger Loop® Shrinkless Wet Mop	086876061048	68
FGC25306	BL00	Swinger Loop® Shrinkless Wet Mop	086876061055	68
FGC25306	OR00	Swinger Loop® Shrinkless Wet Mop	086876171518	68
FGC25406	WH00	Swinger Loop® Shrinkless Wet Mop	086876061277	68
FGC25406	BL00	Swinger Loop® Shrinkless Wet Mop	086876061291	68
FGC25406	GR00	Swinger Loop® Shrinkless Wet Mop	086876145236	68
FGC41206	WH00	Swinger Loop® Finish Mop		68
FGC41306	WH00	Swinger Loop® Finish Mop		68
FGCC16	BK	Metallic Steel Container Open-Top		163
FGCC16	SSS	Metallic Steel Container Open-Top		164
FGCC16	SBS	Metallic Steel Container Open-Top		164
FGCC16	MC	Metallic Steel Container Open-Top		164
FGCC16E	BK	Steel Container Open-Top		167
FGCC400DC		Candy Thermometer		271
FGCM200C		Meat Thermometer		271
FGCOT550C		Oven Thermometer		271
FGD11306	WH00	Super Stitch® Cotton Looped-End Wet Mop		69
FGD21106	WH00	Super Stitch® Blend Mop	086876064377	69
FGD21106	BL00	Super Stitch® Blend Mop	086876064391	69
FGD21206	GR00	Super Stitch® Blend Mop	086876064582	69
FGD21206	WH00	Super Stitch® Blend Mop	086876064575	69
FGD21206	RD00	Super Stitch® Blend Mop	086876155013	69
FGD21306	WH00	Super Stitch® Blend Mop	086876064773	69
FGD21306	GR00	Super Stitch® Blend Mop	086876064780	69

¹ FedEx shippable items.

* Contact Customer Service for UPC information not provided.

Part	Color	Description	UPC	Page
FGD21306	BL00	Super Stitch® Blend Mop	086876064797	69
FGD21306	RD00	Super Stitch® Blend Mop	086876155020	69
FGD21406	WH00	Super Stitch® Blend Mop		69
FGD25106	GR00	Super Stitch® Blend Mop		69
FGD25106	WH00	Super Stitch® Blend Mop	086876065176	69
FGD25106	BL00	Super Stitch® Blend Mop	086876065190	69
FGD25206	WH00	Super Stitch® Blend Mop	086876065374	69
FGD25206	GR00	Super Stitch® Blend Mop	086876065381	69
FGD25206	BL00	Super Stitch® Blend Mop	086876065398	69
FGD25206	RD00	Super Stitch® Blend Mop	086876155037	69
FGD25306	WH00	Super Stitch® Blend Mop	086876065572	69
FGD25306	GR00	Super Stitch® Blend Mop	086876065589	69
FGD25306	BL00	Super Stitch® Blend Mop	086876065596	69
FGD25306	RD00	Super Stitch® Blend Mop	086876155044	69
FGD25406	WH00	Super Stitch® Rayon Mop		69
FGD41206	WH00	Super Stitch® Rayon Mop		69
FGD41306	WH00	Super Stitch® Rayon Mop		69
FGD45206	WH00	Super Stitch® Rayon Mop		69
FGD45306	WH00	Super Stitch® Rayon Mop		69
FGD51206	WH00	Super Stitch® Finish Mop		69
FGD51306	WH00	Super Stitch® Finish Mop		69
FGD5206	WH00	Super Stitch® Finish Mop		69
FGD5306	WH00	Super Stitch® Finish Mop		69
FGDCR24C	DP	Silhouette Recycling Square 29 Gal – Cans		158
FGDCR24C	SM	Silhouette Recycling Square 29 Gal – Cans		158
FGDCR24C	TBK	Silhouette Recycling Square 29 Gal – Cans		158
FGDCR24C	SS	Silhouette Recycling Square 29 Gal – Cans		158
FGDCR24P	DP	Silhouette Recycling Square 29 Gal – Paper		158
FGDCR24P	SM	Silhouette Recycling Square 29 Gal – Paper		158
FGDCR24P	TBK	Silhouette Recycling Square 29 Gal – Paper		158
FGDCR24P	SS	Silhouette Recycling Square 29 Gal – Paper		158
FGDCR24T	DP	Silhouette Recycling Square 29 Gal – Trash		158
FGDCR24T	SM	Silhouette Recycling Square 29 Gal – Trash		158
FGDCR24T	TBK	Silhouette Recycling Square 29 Gal – Trash		158
FGDCR24T	SS	Silhouette Recycling Square 29 Gal – Trash		158
FGDM12SUT	GTM	Accents Ash/Trash		160
FGDM12SUT	MBM	Accents Ash/Trash		160
FGDM12SUT	SRG	Accents Ash/Trash		160
FGDM12T	GTM	Accents Waste Receptacle		160
FGDM12T	MBM	Accents Waste Receptacle		160
FGDM12T	SRG	Accents Waste Receptacle		160
FGDRR24C	DP	Silhouette Recycling Round 26 Gal – Cans		158
FGDRR24C	SM	Silhouette Recycling Round 26 Gal – Cans		158
FGDRR24C	TBK	Silhouette Recycling Round 26 Gal – Cans		158
FGDRR24C	SS	Silhouette Recycling Round 26 Gal – Cans		158
FGDRR24P	DP	Silhouette Recycling Round 26 Gal – Paper		158
FGDRR24P	SM	Silhouette Recycling Round 26 Gal – Paper		158
FGDRR24P	TBK	Silhouette Recycling Round 26 Gal – Paper		158
FGDRR24P	SS	Silhouette Recycling Round 26 Gal – Paper		158
FGDRR24T	DP	Silhouette Recycling Round 26 Gal – Trash		158
FGDRR24T	SM	Silhouette Recycling Round 26 Gal – Trash		158
FGDRR24T	TBK	Silhouette Recycling Round 26 Gal – Trash		158
FGDRR24T	SS	Silhouette Recycling Round 26 Gal – Trash		158
FGDS12SUT	SBS	Accents Ash/Trash	097591108499	160
FGDS12SUT	SSS	Accents Ash/Trash	097591108505	160
FGDS12T	SSS	Accents Waste Receptacle	097591108468	160
FGDS12T	SBS	Accents Waste Receptacle	097591108505	160
FGDT2488		4-Function Digital Timer	086876203981	271
FGDW12SUT	MAH	Accents Ash/Trash		160
FGDW12T	MAH	Accents Waste Receptacle		160
FGE05200	WH00	Finish Mop, Looped Fringe		57
FGE13600	WH00	Universal Headband Cotton Mop		70
FGE13800	WH00	Universal Headband Cotton Mop		70
FGE13900	WH00	Universal Headband Cotton Mop		70
FGE23600	BL00	Universal Headband Blue Blend Mop		70
FGE23800	BL00	Universal Headband Blue Blend Mop		70
FGE23900	BL00	Universal Headband Blue Blend Mop		70
FGE43600	WH00	Universal Headband Rayon Mop		70
FGE43800	WH00	Universal Headband Rayon Mop		70
FGE43900	WH00	Universal Headband Rayon Mop		70
FGF11600	WH00	Premium Cut-End Cotton Mop		71
FGF11700	WH00	Premium Cut-End Cotton Mop		71
FGF11800	WH00	Premium Cut-End Cotton Mop		71
FGF11900	WH00	Premium Cut-End Cotton Mop		71
FGF13100	BL00	Synthetic Blend Mop	086876116304	73
FGF13100	PINK	Synthetic Blend Mop	086876116328	73
FGF13100	GR00	Synthetic Blend Mop		73
FGF13200	BL00	Synthetic Blend Mop	086876116342	73
FGF13200	PINK	Synthetic Blend Mop	086876116366	73
FGF13200	GR00	Synthetic Blend Mop		73
FGF13600	BL00	Synthetic Blend Mop	086876116427	73
FGF13600	PINK	Synthetic Blend Mop	086876116441	73
FGF13600	GR00	Synthetic Blend Mop		73
FGF13700	BL00	Synthetic Blend Mop	086876116465	73
FGF13700	PINK	Synthetic Blend Mop	086876116489	73
FGF13700	GR00	Synthetic Blend Mop		73
FGF15600	WH00	Premium Cut-End Cotton Mop		71
FGF15700	WH00	Premium Cut-End Cotton Mop		71

Part	Color	Description	UPC	Page
FGF15800	WH00	Premium Cut-End Cotton Mop		71
FGF15900	WH00	Premium Cut-End Cotton Mop		71
FGF16600	WH00	Premium Bolt-On Cut-End Cotton Mop		72
FGF16700	WH00	Premium Bolt-On Cut-End Cotton Mop		72
FGF16800	WH00	Premium Bolt-On Cut-End Cotton Mop		72
FGF16900	WH00	Premium Bolt-On Cut-End Cotton Mop		72
FGF21600	WH00	Premium 8-Ply Cut-End Cotton Mop		72
FGF21700	WH00	Premium 8-Ply Cut-End Cotton Mop		72
FGF21800	WH00	Premium 8-Ply Cut-End Cotton Mop		72
FGF21900	WH00	Premium 8-Ply Cut-End Cotton Mop		72
FGF41600	WH00	Premium Cut-End Rayon Mop		71
FGF41700	WH00	Premium Cut-End Rayon Mop		71
FGF41800	WH00	Premium Cut-End Rayon Mop		71
FGF46700	WH00	Premium Bolt-On Cut-End Rayon Mop		72
FGF46800	WH00	Premium Bolt-On Cut-End Rayon Mop		72
FGF51600	WH00	Premium Cut-End Blend Mop	086876046106	71
FGF51600	BL00	Premium Cut-End Blend Mop	086876049145	71
FGF51700	WH00	Premium Cut-End Blend Mop	086876045932	71
FGF51700	BL00	Premium Cut-End Blend Mop	086876049152	71
FGF51800	WH00	Premium Cut-End Blend Mop	086876045857	71
FGF51800	BL00	Premium Cut-End Blend Mop	086876049169	71
FGF51900	WH00	Premium Cut-End Blend Mop	086876046083	71
FGF51900	BL00	Premium Cut-End Blend Mop	086876049121	71
FGF55600	WH00	Premium Cut-End Blend Mop	086876047820	71
FGF55600	BL00	Premium Cut-End Blend Mop	086876070408	71
FGF55700	WH00	Premium Cut-End Blend Mop	086876047837	71
FGF55700	BL00	Premium Cut-End Blend Mop	086876070521	71
FGF55800	WH00	Premium Cut-End Blend Mop	086876047844	71
FGF55800	BL00	Premium Cut-End Blend Mop	086876070644	71
FGF55900	WH00	Premium Cut-End Blend Mop	086876050301	71
FGF55900	BL00	Premium Cut-End Blend Mop	086876070767	71
FGF56600	WH00	Premium Bolt-On Cut-End Blend Mop		72
FGF56600	BL00	Premium Bolt-On Cut-End Blend Mop	086876071009	72
FGF56700	BL00	Premium Bolt-On Cut-End Blend Mop	086876064537	72
FGF56800	WH00	Premium Bolt-On Cut-End Blend Mop	086876050349	72
FGF56800	BL00	Premium Bolt-On Cut-End Blend Mop		72
FGF56900	BL00	Premium Bolt-On Cut-End Blend Mop		72
FGFG1219LO		Fiberglass One-Piece Lift-Off		175
FGFG1227FT		Fiberglass Ash/Trash Container Funnel Top		175
FGFG1227SU		Fiberglass Ash/Trash Container Sand Top		175
FGFG1628LO		Fiberglass One-Piece Lift-Off		175
FGFG1630C		Fiberglass Recycling Container – Can		176
FGFG1630P		Fiberglass Recycling Container – Paper		176
FGFG1630SQ		Fiberglass Recycling Container – Can		176
FGFG1630SQP		Fiberglass Recycling Container – Paper		176
FGFG1630SQSUT		Fiberglass Ash/Trash Container Sand Top		175
FGFG1630SQT		Open-Top Square		171
FGFG1630SUT		Fiberglass Ash/Trash Container Sand Top		175
FGFG1630T		Open-Top Round		171
FGFG1630TSA		Open-Top with Satin Aluminum Top		171
FGFG1630TSB		Open-Top with Satin Brass Top		171
FGFG1639		Covered Top Round		173
FGFG1639SU		Fiberglass Ash/Trash Container Covered Top		175
FGFG1829C		Fiberglass Recycling Container – Can		176
FGFG1829P		Fiberglass Recycling Container – Paper		176
FGFG1829T		Open-Top Round		171
FGFG1829TSA		Open-Top with Satin Aluminum Top		171
FGFG1829TSB		Open-Top with Satin Brass Top		171
FGFG1830LO		Fiberglass One Piece Lift Off		175
FGFG1837		Covered Top Round		173
FGFG1837SU		Fiberglass Ash/Trash Container Covered Top		175
FGFG2030SQT		Open-Top Square		171
FGFG2032		Open-Top Round		171
FGFG2037SQTR		Foodcourt Covered Tray Top		173
FGFG2038SQ		Covered Top Square		173
FGFG2432		Open-Top Round		171
FGFG2432SQSUT		Fiberglass Ash/Trash Container Sand Top		175
FGFG2432TSA		Open-Top with Satin Aluminum Top		171
FGFG2432TSB		Open-Top with Satin Brass Top		171
FGFG2438		Open-Top Round		171
FGFG2438SQ		Covered Top Square		173
FGFG2438SQTR		Foodcourt Covered Tray Top		173
FGFG2439		Covered Top Round		173
FGFG2439TR		Foodcourt Covered Tray Top		173
FGFGC1630T	Concrete	Cornerstone Series™ Open-Top		171
FGFGC1639	Concrete	Cornerstone Series™ Covered Top		171
FGFGC2035T	Concrete	Cornerstone Series™ Open-Top		171
FGFGC2044	Concrete	Cornerstone Series™ Covered Top		171
FGFGC2437T	Concrete	Cornerstone Series™ Open-Top		171
FGFGC2446	Concrete	Cornerstone Series™ Covered Top		171
FGFGC2446WU	Concrete	Cornerstone Series™ Covered Top w/ Weather Urn		171
FGFGH2436		Half Round Open Front		175
FGFGH2436SU		Fiberglass Ash/Trash Container Half Round Open Front		175
FGFGH2436SUT		Fiberglass Ash/Trash Container Half Round Open-Top		175
FGFGK1824	BISQ	Milan Collection Tuscan Open-Top		169
FGFGK1824	SAH	Milan Collection Tuscan Open-Top		169

¹ FedEx shippable items.

* Contact Customer Service for UPC information not provided.

Part	Color	Description	UPC	Page
FGFGK1824	WTRC	Milan Collection Tuscan Open-Top		169
FGFGK1824SU	BISQ	Milan Collection Tuscan Urn		169
FGFGK1824SU	SAH	Milan Collection Tuscan Urn		169
FGFGK1924	BISQ	Milan Collection Pescara Open-Top		169
FGFGK1924	BK	Milan Collection Pescara Open-Top		169
FGFGK1924	SAH	Milan Collection Pescara Open-Top		169
FGFGK1924	WTRC	Milan Collection Pescara Open-Top		169
FGFGK1924SU	BISQ	Milan Collection Pescara Urn		169
FGFGK1924SU	BR	Milan Collection Pescara Urn		169
FGFGK1924SU	SAH	Milan Collection Pescara Urn		169
FGFGK1924SU	WTC	Milan Collection Pescara Urn		169
FGFGK2130	BISQ	Milan Collection Pescara Open-Top		169
FGFGK2130	SAH	Milan Collection Pescara Open-Top		169
FGFGK2130	WTRC	Milan Collection Pescara Open-Top		169
FGFGK2433	BISQ	Milan Collection Tuscan Open-Top		169
FGFGK2433	SAH	Milan Collection Tuscan Open-Top		169
FGFGK2433	WTRC	Milan Collection Tuscan Open-Top		169
FGFGK2736	BISQ	Milan Collection Tuscan Open-Top		169
FGFGK2736	SAH	Milan Collection Tuscan Open-Top		169
FGFGK2736	WTRC	Milan Collection Tuscan Open-Top		169
FGFGK2736SUT	BIS	Milan Collection Tuscan Ash/Trash		169
FGFGK2736SUT	SAH	Milan Collection Tuscan Ash/Trash		169
FGFGK2836	BISQ	Milan Collection Portofino Open-Top		169
FGFGK2836	SAH	Milan Collection Portofino Open-Top		169
FGFGK2836	WTRC	Milan Collection Portofino Open-Top		169
FGFGK2836SUT	BIS	Milan Collection Portofino Ash/Trash		169
FGFGK2836SUT	SAH	Milan Collection Portofino Ash/Trash		169
FGFGK2836SUT	WTC	Milan Collection Portofino Ash/Trash		169
FGFGK2936	BISQ	Milan Collection Pescara Open-Top		169
FGFGK2936	SAH	Milan Collection Pescara Open-Top		169
FGFGK2936	WTRC	Milan Collection Pescara Open-Top		169
FGFGK2936SUT	BIS	Milan Collection Pescara Ash/Trash		169
FGFGK2936SUT	SAH	Milan Collection Pescara Ash/Trash		169
FGFGL1824GSU		Galleria Sand-Top Urn		171
FGFGL2730GSUT		Galleria Sand-Top Ash/Trash		171
FGFGL2730GT		Galleria Receptacle		171
FGFGPF2419	BISQ	Milan Planter		169
FGFGPF2419	SAH	Milan Planter		169
FGFGPF3025	BISQ	Milan Planter		169
FGFGPF3025	SAH	Milan Planter		169
FGFGPF3626	BISQ	Milan Planter		169
FGFGPF3626	SAH	Milan Planter		169
FGFGPK-Model K		Mediterranean Planter		203
FGFGLP-Model L		Galleria Planter		203
FGFGPM-Model M		Round Rimless Planter		203
FGFGPN-Model N		Rectangular Planter w/ Return Rim		203
FGFGPO-Model O		Square Planter w/ Return Rim		203
FGFGPP-Model P		Round Planter w/ Return Rim		203
FGFGPT-Model T		Tuscany Planter		169, 203
FGFGR3418TC		Fiberglass Large-Capacity 2-Section Recycling Center		176
FGFGR3418TP		Fiberglass Large-Capacity 2-Section Recycling Center		176
FGFGR3616TPC		Fiberglass 3-Section Recycling Center		176
FGFGR4816TGPC		Fiberglass 4-Section Recycling Center		176
FGFGR5220		Fiberglass Shapes Recycling Center		176
FGFGT2433SQ		Tuscany Collection™ Square		169
FGFTH1	BK	Towne Series Funnel Top for use w/ H1N		189
FGFTH3	BK	Towne Series Funnel Top for use w/ H3		189
FGFTH9	BK	Towne Series Funnel Top for use w/ H9N		189
FGG78004		PVA Sponge Mop		77
FGG78112		PVA Sponge Mop Refill		77
FGGO4204	WH00	Cotton Mop and Handle Combination		77
FGGO4300	WH00	Replacement Mop Head for FGGO4204		77
FGH11500	0000	Invader® Side-Gate Wet Mop Handle, Large Yellow Plastic Head, Hardwood Handle		75
FGH11600	0000	Invader® Side-Gate Wet Mop Handle, Large Yellow Plastic Head, Hardwood Handle		75
FGH11700	0000	Invader® Side-Gate Wet Mop Handle, Large Black Plastic Head, Bamboo Composite Handle	086876204018	75
FGH12400	0000	User-Friendly Mop Handle with Side-Gate Head		76
FGH12500	0000	Invader® Side-Gate Wet Mop Handle, Large Yellow Plastic Head, Gray Aluminum Handle		75
FGH12600	0000	Invader® Side-Gate Wet Mop Handle, Large Yellow Plastic Head, Gray Aluminum Handle		75
FGH12IG	C	Towne Series Post-Mount w/ Ground Post		189
FGH12SM	C	Towne Series Post-Mount w/ Surface Post		189
FGH13500	0000	Invader® Side-Gate Wet Mop Handle, Large Yellow Plastic Head, Vinyl-Covered Aluminum Handle		75
FGH13600	0000	Invader® Side-Gate Wet Mop Handle, Large Yellow Plastic Head, Vinyl-Covered Aluminum Handle		75
FGH14500	0000	Invader® Side-Gate Wet Mop Handle, Large Yellow Plastic Head, Fiberglass Handle		75
FGH14600	GR00	Invader® Side-Gate Wet Mop Handle, Large Yellow Plastic Head, Fiberglass Handle	086876146875	75
FGH14600	RD00	Invader® Side-Gate Wet Mop Handle, Large Yellow Plastic Head, Fiberglass Handle	086876146882	75

¹ FedEx shippable items.

Part	Color	Description	UPC	Page
FGH14600	BL00	Invader® Side-Gate Wet Mop Handle, Large Yellow Plastic Head, Fiberglass Handle	086876146899	75
FGH14600	GY00	Invader® Side-Gate Wet Mop Handle, Large Yellow Plastic Head, Fiberglass Handle	086876147353	75
FGH1N	BK	Towne Series Pole/Wall-Mount	097591082966	189
FGH1N	EGN	Towne Series Pole/Wall-Mount	097591082980	189
FGH1NLIIDKIT	EGN	Towne Series Lid Kit	097591103135	189
FGH1NLIIDKIT	BK	Towne Series Lid Kit	097591103142	189
FGH21500	0000	Gripper® Clamp-Style Wet Mop Handle, Plastic Yellow Head, Hardwood Handle		75
FGH21600	0000	Gripper® Clamp-Style Wet Mop Handle, Plastic Yellow Head, Hardwood Handle		75
FGH21700	0000	Gripper® Clamp-Style Wet Mop Handle, Plastic Black Head, Bamboo Composite Handle	086876204636	75
FGH22400	0000	User-Friendly Mop Handle with Clamp-Style Head		76
FGH22500	0000	Gripper® Clamp-Style Wet Mop Handle, Plastic Yellow Head, Gray Aluminum Handle		75
FGH22600	0000	Gripper® Clamp-Style Wet Mop Handle, Plastic Yellow Head, Gray Aluminum Handle		75
FGH23500	0000	Gripper® Clamp-Style Wet Mop Handle, Plastic Yellow Head, Vinyl-Coated Aluminum Handle		75
FGH23600	0000	Gripper® Clamp-Style Wet Mop Handle, Plastic Yellow Head, Vinyl-Coated Aluminum Handle		75
FGH24500	0000	Gripper® Clamp-Style Wet Mop Handle, Plastic Yellow Head, Fiberglass Handle		75
FGH24600	GR00	Gripper® Clamp-Style Wet Mop Handle, Plastic Yellow Head, Fiberglass Handle	086876146905	75
FGH24600	RD00	Gripper® Clamp-Style Wet Mop Handle, Plastic Yellow Head, Fiberglass Handle	086876146912	75
FGH24600	BL00	Gripper® Clamp-Style Wet Mop Handle, Plastic Yellow Head, Fiberglass Handle	086876146929	75
FGH24600	GY00	Gripper® Clamp-Style Wet Mop Handle, Plastic Yellow Head, Fiberglass Handle	086876147360	75
FGH3	EGN	Towne Series Free-Standing w/ Security Chain Holes	097591072660	189
FGH3	BK	Towne Series Free-Standing w/ Security Chain Holes	097591092767	189
FGH31600	0000	Bolt-On Wet Mop Handle, Metal Cap, Wood Handle		76
FGH41600	0000	Stirrup-Style Wet Mop Handle, Large Yellow Steel Head, Wood Handle		75
FGH51600	0000	Easy-Change Wet Mop Handle, Large Steel Head, Wood Handle		75
FGH55	C	Towne Series Free-Standing		189
FGH55E	BK	Towne Series Free-Standing	097591024584	189
FGH55E	EGN	Towne Series Free-Standing	097591024614	189
FGH9N	BK	Towne Series Pole/Wall-Mount	097591082997	189
FGH9N	EGN	Towne Series Pole/Wall-Mount	097591083017	189
FGHBRKTKIT	BK	Towne Series Mounting Bracket for H1N, H9N		189
FGHPIG		Towne Series In-Ground Pole w/ Hardware		189
FGHP5M		Towne Series Surface-Mount Pole w/ Hardware		189
FGJ15100	YL00	Trapper® Dust Mop		81
FGJ15700	YL00	Trapper® Dust Mop		81
FGJ25200	BL00	Twisted-Loop Blend Dust Mop	086876182170	80
FGJ25200	YL00	Twisted-Loop Blend Dust Mop	086876182187	80
FGJ25300	BL00	Twisted-Loop Blend Dust Mop	086876182194	80
FGJ25300	YL00	Twisted-Loop Blend Dust Mop	086876182200	80
FGJ25500	BL00	Twisted-Loop Blend Dust Mop	086876182217	80
FGJ25500	YL00	Twisted-Loop Blend Dust Mop	086876182224	80
FGJ25700	BL00	Twisted-Loop Blend Dust Mop	086876182231	80
FGJ25700	YL00	Twisted-Loop Blend Dust Mop	086876182248	80
FGJ25800	BL00	Twisted-Loop Blend Dust Mop	086876182255	80
FGJ25800	YL00	Twisted-Loop Blend Dust Mop	086876182262	80
FGJ35200	BL00	Twisted-Loop Synthetic Dust Mop		80
FGJ35300	BL00	Twisted-Loop Synthetic Dust Mop		80
FGJ35500	BL00	Twisted-Loop Synthetic Dust Mop		80
FGJ35700	BL00	Twisted-Loop Synthetic Dust Mop		80
FGJ35800	BL00	Twisted-Loop Synthetic Dust Mop		80
FGJ55200	GR00	Twisted-Loop Blend Antimicrobial Dust Mop		80
FGJ55300	GR00	Twisted-Loop Blend Antimicrobial Dust Mop		80
FGJ55500	GR00	Twisted-Loop Blend Antimicrobial Dust Mop		80
FGJ55700	GR00	Twisted-Loop Blend Antimicrobial Dust Mop		80
FGJ55800	GR00	Twisted-Loop Blend Antimicrobial Dust Mop		80
FGJ85200	GR00	Microfiber Loop Dust Mop 18"		79
FGJ85300	GR00	Microfiber Loop Dust Mop 24"		79
FGJ85500	GR00	Microfiber Loop Dust Mop 36"		79
FGJ85700	GR00	Microfiber Loop Dust Mop 48"		79
FGJ85900	GR00	Microfiber Loop Dust Mop 60"	086876204063	79
FGJ85900	GR00	Microfiber Loop Dust Mop 72"	086876204070	79
FGK15200	WH00	Kut-A-Way® Dust Mop	086876049176	81
FGK15200	BL00	Kut-A-Way® Dust Mop	086876081336	81
FGK15300	WH00	Kut-A-Way® Dust Mop	086876045499	81
FGK15300	BL00	Kut-A-Way® Dust Mop	086876081855	81
FGK15500	WH00	Kut-A-Way® Dust Mop	086876050677	81
FGK15500	BL00	Kut-A-Way® Dust Mop	086876082913	81
FGK15700	WH00	Kut-A-Way® Dust Mop	086876050691	81
FGK15700	BL00	Kut-A-Way® Dust Mop	086876083958	81
FGK15800	WH00	Kut-A-Way® Dust Mop		81
FGK15900	WH00	Kut-A-Way® Dust Mop		81

* Contact Customer Service for UPC information not provided.

Part	Color	Description	UPC	Page
FGK16SS		Compact Portion Control Scale		267
FGK32		Oven-Run Scale with 1-pt Measuring Cup		267
FGK32CUP		Measuring Cup for FGK32 (1 pt/16 oz/2 cup)		267
FGK75200	WH00	Twisted Loop Cotton Dust Mop		80
FGK75300	WH00	Twisted Loop Cotton Dust Mop		80
FGK75500	WH00	Twisted Loop Cotton Dust Mop		80
FGK75700	WH00	Twisted Loop Cotton Dust Mop		80
FGK75800	WH00	Twisted Loop Cotton Dust Mop		80
FGKF16SS		Compact Portion Control Scale with Contoured Platform		267
FGKSB	7000	Keystone Series™ Bench		191
FGKSB	8000	Keystone Series™ Bench		191
FGKSM10	7000	Keystone Series™ Urn		191
FGKSM10	8000	Keystone Series™ Urn		191
FGKSM32	7000	Keystone Series™ Open-Top	097591039526	191
FGKSM32	8000	Keystone Series™ Open-Top	097591039557	191
FGKSR125U	7000	Keystone Series™ Ash/Trash	097591039724	191
FGKSR125U	8000	Keystone Series™ Ash/Trash	097591039876	191
FGKSR36	7000	Keystone Series™ Hinged Top Receptacle		191
FGKSR36	8000	Keystone Series™ Hinged Top Receptacle		191
FGKSR36WU	7000	Keystone Series™ Hinged Top w/ Weather Urn		191
FGKSR36WU	8000	Keystone Series™ Hinged Top w/ Weather Urn		191
FGKSR48SD	7000	Keystone Series™ Front Door	097591100417	191
FGKSR48SD	8000	Keystone Series™ Front Door	097591100431	191
FGKSR48SDWU	8000	Keystone Series™ Front Door w/ Weather Urn	097591108253	191
FGKSR48SDWU	7000	Keystone Series™ Front Door w/ Weather Urn	097591110362	191
FGL15200	WH00	Blended Cut-End Disposable Dust Mop		81
FGL15300	WH00	Blended Cut-End Disposable Dust Mop	086876045505	81
FGL15300	GR00	Blended Cut-End Disposable Dust Mop	086876087369	81
FGL15500	WH00	Blended Cut-End Disposable Dust Mop	086876087598	81
FGL15500	GR00	Blended Cut-End Disposable Dust Mop	086876087604	81
FGL15700	WH00	Blended Cut-End Disposable Dust Mop	086876087833	81
FGL15700	GR00	Blended Cut-End Disposable Dust Mop	086876087840	81
FGL15800	WH00	Blended Cut-End Disposable Dust Mop		81
FGL15900	WH00	Blended Cut-End Disposable Dust Mop		81
FGL25200	WH00	Cut-End Disposable Cotton Dust Mop		82
FGL25300	WH00	Cut-End Disposable Cotton Dust Mop		82
FGL25500	WH00	Cut-End Disposable Cotton Dust Mop		82
FGL25700	WH00	Cut-End Disposable Cotton Dust Mop		82
FGM11600	0000	Snap-On Dust Mop Handle, Hardwood		84
FGM11700	0000	Snap-On Dust Mop Handle, Bamboo Composite	086876204629	84
FGM13600	0000	Snap-On Dust Mop Handle, Vinyl-Covered, Hardwood		84
FGM14600	0000	Snap-On Dust Mop Handle, Fiberglass		84
FGM15000	WH00	Cut-to-Length Dust Mop		83
FGM25100	0000	Snap-On Wire Dust Mop Frame		84
FGM25200	0000	Snap-On Wire Dust Mop Frame		84
FGM25300	0000	Snap-On Wire Dust Mop Frame		84
FGM25500	0000	Snap-On Wire Dust Mop Frame		84
FGM25700	0000	Snap-On Wire Dust Mop Frame		84
FGM25800	0000	Snap-On Wire Dust Mop Frame		84
FGM25900	0000	Snap-On Wire Dust Mop Frame		84
FGMH24	BK	Avenue Open-Top		179
FGMH32	BK	Avenue Round Open-Top		179
FGMH46	BK	Avenue Open-Top		179
FGMHR36	BK	Avenue Open-Top		179
FGMH50Q18	BK	Avenue Open-Top		179
FGMST15	SS	Medi-Can™ Step Can		144
FGMST15E	WH	Medi-Can™ Step Can		144
FGMST35	SS	Medi-Can™ Step Can		144
FGMST35E	RD	Medi-Can™ Step Can		144
FGMST35E	WH	Medi-Can™ Step Can		144
FGMST7	SS	Medi-Can™ Step Can		144
FGMST7E	WH	Medi-Can™ Step Can		144
FGMT12	ABZ	Americana Series™ Urn		179
FGMT12	BK	Americana Series™ Urn		179
FGMT12	VSGN	Americana Series™ Urn		179
FGMT22	ABZ	Americana Series™ Open-Top		179
FGMT22	BK	Americana Series™ Open-Top		179
FGMT22	VSGN	Americana Series™ Open-Top		179
FGMT32	ABZ	Americana Series™ Open-Top		179
FGMT32	BK	Americana Series™ Open-Top		179
FGMT32	VSGN	Americana Series™ Open-Top		179
FGNC24	BEIGE	Collect-A-Cubes™ Recycling Cube		177
FGNC24L	BEIGE	Collect-A-Cubes™ Recycling Cube w/ Lock		177
FGNC30	BEIGE	Collect-A-Cubes™ Recycling Cube		177
FGNC30L	BEIGE	Collect-A-Cubes™ Recycling Cube w/ Lock		177
FGNC36	BEIGE	Collect-A-Cubes™ Recycling Cube		177
FGNC36L	BEIGE	Collect-A-Cubes™ Recycling Cube w/ Lock		177
FGOB55	BK	Classics Recessed Base Ring		185
FGP100S		Briefcase Receiving Scale		268
FGP114S		Briefcase Receiving Scale – Metric		268
FGP11700	WH00	Standard Thickness Bonnet		85
FGP11900	WH00	Standard Thickness Bonnet		85
FGP12100	WH00	Standard Thickness Bonnet		85
FGP250S		Briefcase Receiving Scale		268
FGP250S		Briefcase Receiving Scale		268
FGP25700	WH00	Low-Profile Bonnet		85

Part	Color	Description	UPC	Page
FGP25900	WH00	Low-Profile Bonnet		85
FGP26100	WH00	Low-Profile Bonnet		85
FGP26700	WH00	Low-Profile with Green Scrub Strips Bonnet		85
FGP26900	WH00	Low-Profile with Green Scrub Strips Bonnet		85
FGP27100	WH00	Low-Profile with Green Scrub Strips Bonnet		85
FGQ05000	0000	Microfiber Finish System, Includes Bucket with Lid, Sieve, 8 Pads, 1 Frame		57
FGQ11000	BK00	11" (27.9 cm) Hook-and-Loop Replacement Set for FGQ55000	086876174885	50
FGQ18000	BK00	18" (45.7 cm) Hook-and-Loop Replacement Set for FGQ56000	086876174892	50
FGQ20000	WH00	Rubbermaid FLOW™ QC String Mop		56
FGQ21700	WH00	17" Low-Profile Microfiber Carpet Bonnet		85
FGQ21900	WH00	19" Low-Profile Microfiber Carpet Bonnet		85
FGQ22100	WH00	21" Low-Profile Microfiber Carpet Bonnet		85
FGQ24000	BK00	24" (61 cm) Hook-and-Loop Replacement Set for FGQ57000	086876174908	50
FGQ25700	WH00	17" Microfiber Carpet Bonnet		85
FGQ25900	WH00	19" Microfiber Carpet Bonnet		85
FGQ26100	WH00	21" Microfiber Carpet Bonnet		85
FGQ31100	GRAY	Upright Scrubber Pad Holder with Universal Locking Collar		77
FGQ31400	GY00	Upright Scrubber Pad Holder With Threaded Adapter		77
FGQ32200	BK00	Dust Cloth Holder		83
FGQ32600	YL00	Stretch Cleaning and Dusting Cloth		83
FGQ36000	BK00	36" (91.4 cm) Hook and Loop Replacement Set for FGQ58000	086876174915	50
FGQ41000	BL00	18" (45.7 cm) Microfiber Damp Room Mop	086876170016	51
FGQ41000	RD00	18" (45.7 cm) Microfiber Damp Room Mop	086876174045	51
FGQ41000	GR00	18" (45.7 cm) Microfiber Damp Room Mop	086876174052	51
FGQ41100	BL00	24" (61 cm) Microfiber Damp Room Mop	086876173734	51
FGQ41200	WH00	18" (45.7 cm) Microfiber Room Dust Mop	086876170023	51
FGQ41200	GR00	18" (45.7 cm) Microfiber Room Dust Mop	086876175448	51
FGQ41500	BL00	18" (45.7 cm) Microfiber Damp Mop with Scrubber	086876174946	51
FGQ41600	BL00	18" (45.7 cm) Microfiber High-Absorbency Mop	086876174960	51
FGQ41800	GR00	18" (45.7 cm) Microfiber Fringed Dust Mop	086876174939	51
FGQ42400	GR00	24" (61 cm) Microfiber Hall Dust Mop	086876170139	51
FGQ42500	BL00	24" (61 cm) Microfiber Damp Mop with Scrubber	086876174953	51
FGQ42600	GR00	24" (61 cm) Microfiber Fringed Dust Mop	086876182484	51
FGQ43600	GR00	36" (91.4 cm) Microfiber Hall Dust Mop	086876170047	51
FGQ43800	GR00	36" (91.4 cm) Microfiber Fringed Dust Mop	086876182491	51
FGQ44800	GR00	48" (121.9 cm) Microfiber Hall Dust Mop	086876170146	51
FGQ44900	GR00	48" (121.9 cm) Microfiber Fringed Dust Mop	086876182507	51
FGQ46000	GR00	60" (152.4 cm) Microfiber Fringed Dust Mop	086876182514	51
FGQ48000	BK00	48" (121.9 cm) Hook-and-Loop Replacement Set for FGQ59000	086876174922	50
FGQ55000	YL00	11" (27.9 cm) Quick-Connect Wall/Stair Frame	086876174823	50
FGQ55900	BK00	18" (45.7 cm) Economy Quick-Connect Wet/Dry Plastic Frame	086876186079	55
FGQ56000	YL00	18" (45.7 cm) Quick-Connect Wet/Dry Frame	086876174830	50
FGQ57000	YL00	24" (61 cm) Quick-Connect Squeegee Frame	086876174847	50
FGQ57100	GY00	24" (61 cm) Squeegee Blade Replacement for FGQ57000	086876175165	50
FGQ58000	YL00	36" (91.4 cm) Quick-Connect Hall Dusting Frame	086876174854	50
FGQ59000	YL00	48" (121.9 cm) Quick-Connect Hall Dusting Frame	086876174861	50
FGQ59500	YL00	60" (152.4 cm) Quick-Connect Hall Dusting Frame	086876182477	50
FGQ60000	BK00	60" (152.4 cm) Hook-and-Loop Replacement Set for FGQ59500	086876186345	50
FGQ61000	YL00	Microfiber Bathroom Cloth (Yellow)	086876170085	53
FGQ61006	YL00	Microfiber Bathroom Cloth (Yellow)	086876178593	53
FGQ62000	GR00	Microfiber General-Purpose Cloth (Green, Red, or Blue)	086876170092	53
FGQ62000	RD00	Microfiber General-Purpose Cloth (Green, Red, or Blue)	086876179101	53
FGQ62000	BL00	Microfiber General-Purpose Cloth (Green, Red, or Blue)		53
FGQ62006	GR00	Microfiber General-Purpose Cloth (Green)	086876170092	53
FGQ63000	BL00	Microfiber Glass/Mirror Cloth (Blue)	086876170108	53
FGQ63006	BL00	Microfiber Glass/Mirror Cloth (Blue)	086876178616	53
FGQ64000	GR00	Microfiber XL General-Purpose Cloth (Green)	086876170115	53
FGQ65000	GR00	Microfiber All-Purpose Mitt with Thumb	086876173765	53
FGQ65100	BL00	Microfiber Glass/Mirror Mitt with Thumb	086876173772	53
FGQ65200	GR00	Microfiber Dusting Mitt with Thumb	086876200966	53
FGQ70100	BK00	ACME to Quick-Connect Adapter	086876201000	49
FGQ74500	YL00	20"-40" (50.8 cm–101.6 cm) Quick-Connect Short Extension Handle	086876182453	49
FGQ74900	YL00	52" (132 cm) Economy Quick-Connect Steel Handle	086876186086	55
FGQ75000	YL00	58" (147.3 cm) Quick-Connect Handle	086876174809	49
FGQ75500	YL00	48"-72" (121.9 cm–182.9 cm) Quick-Connect Straight Extension Handle	086876182460	49
FGQ76000	0000	48"-72" (121.9 cm–182.9 cm) Quick-Connect Ergo Adjustable Handle	086876174816	49
FGQ76500	YL00	4'-8" Quick-Connect Extension Pole	086876201017	49
FGQ77000	YL00	6'-12" Quick-Connect Extension Pole	086876201021	49

¹ FedEx shippable items.

* Contact Customer Service for UPC information not provided.

Part	Color	Description	UPC	Page
FGQ77500	YL00	6-18' Quick-Connect Extension Pole	086876201116	49
FGQ80000	WH00	18" (45.7 cm) Microfiber Finish Pad		57
FGQ80500	WH00	Rubbermaid FLOW™ Nylon Flat Mop		56
FGQ81000	YL00	18" (45.7 cm) Microfiber Super Scrubber Mop	086876173727	51
FGQ82000	BL00	11" (27.9 cm) Microfiber Wall/Stair Damp Mop	086876173741	51
FGQ85000	BK00	Quick-Connect Flexible Dusting Wand with Microfiber Sleeve	086876174977	52
FGQ85100	GR00	Wand Duster Microfiber Replacement Sleeve	086876174984	52
FGQ85200	WH00	Executive Series™ Quick-Connect Flexible Dusting Wand with High-Performance Sleeve	086876200942	52
FGQ85300	WH00	Executive Series™ Wand Duster High-Performance Microfiber Replacement Sleeve	086876200959	52
FGQ85500	BK00	11" Microfiber Flexi-Frame	086876200898	52
FGQ85600	GR00	Microfiber Flexi-Frame Duster Cover	086876200904	52
FGQ86100	WH00	Executive Series™ Microfiber Flexi-Frame Hi-Pile Cover	086876200911	52
FGQ87100	BL00	Microfiber Flexi-Frame Glass Cover	086876201109	52
FGQ88100	YL00	Microfiber Flexi-Frame Tub and Tile Cover	086876200925	52
FGQ89100	BL00	Microfiber Flexi-Frame Damp Mop Cover	086876201789	52
FGQ90088	YEL	Press Wring Bucket	086876176827	47
FGQ93000	BLUE	Finish Bucket		57
FGQ95088	YEL	Charging Bucket	086876206418	47
FGQ96600	0000	Rubbermaid PULSE™ Caddy	086876192360	49
FGQ97700	0000	Rubbermaid FLOW™ Replacement Bladder	086876192339	56
FGQ97900	YL00	Rubbermaid FLOW™ Flat Mop Finish Kit		56
FGQ98900	YL00	Rubbermaid FLOW™ String Mop Finish Kit		56
FGQST12	SS	The Silent Defenders® Quiet Step Can		144
FGQST12E	RD	The Silent Defenders® Quiet Step Can		144
FGQST12E	WH	The Silent Defenders® Quiet Step Can		144
FGQST24	SS	The Silent Defenders® Quiet Step Can		144
FGQST24E	RD	The Silent Defenders® Quiet Step Can		144
FGQST24E	WH	The Silent Defenders® Quiet Step Can		144
FGQST40	SS	The Silent Defenders® Quiet Step Can		144
FGQST40E	RD	The Silent Defenders® Quiet Step Can		144
FGQST40E	WH	The Silent Defenders® Quiet Step Can		144
FGQST40EW	RD	The Silent Defenders® Quiet Step Can w/ Wheels		144
FGQST40EW	WH	The Silent Defenders® Quiet Step Can w/ Wheels		144
FGQST40SW	SS	The Silent Defenders® Quiet Step Can w/ Wheels		144
FGQST7	SS	The Silent Defenders® Quiet Step Can		144
FGQST7E	RD	The Silent Defenders® Quiet Step Can		144
FGQST7E	WH	The Silent Defenders® Quiet Step Can		144
FGR1	SM	Smokers' Pole	097591109106	198
FGR1	BK	Smokers' Pole	097591109113	198
FGR1012	SS	Smokers' Station® Wall-Mount Urn w/ Keyed Cam Lock		201
FGR1012E	BK	Smokers' Station® Wall-Mount Urn w/ Keyed Cam Lock		201
FGR12	SBK	Dimension Series Flat Top		186
FGR12	500	Dimension Series Flat Top		186
FGR12	201	Aspen Flat Top		187
FGR12	202	Aspen Flat Top		187
FGR12	2000	Aspen Flat Top		187
FGR12	6000	Aspen Flat Top		187
FGR12SU	SBK	Dimension Series Ash/Trash		186
FGR12SU	201	Aspen Ash/Trash		187
FGR12SU	202	Aspen Ash/Trash		187
FGR12SU	2000	Aspen Ash/Trash		187
FGR12SU	6000	Aspen Ash/Trash		187
FGR12WU	SBK	Dimension Series Ash/Trash w/ Weather Urn		186
FGR12WU	500	Dimension Series Ash/Trash w/ Weather Urn		186
FGR12WU	201	Aspen Ash/Trash w/ Weather Urn		187
FGR12WU	202	Aspen Ash/Trash w/ Weather Urn		187
FGR12WU	2000	Aspen Ash/Trash w/ Weather Urn		187
FGR12WU	6000	Aspen Ash/Trash w/ Weather Urn		187
FGR1450	EGN	Regent 50 Series Flat Top		190
FGR145U50	EGN	Regent 50 Series Ash/Trash		190
FGR14WU50	EGN	Regent 50 Series Ash/Trash w/ Weather Urn		190
FGR1530	MC	Metallic Steel Container Round-Top		164
FGR1530E	BK	Steel Containers Round-Top		167
FGR1530E	COB	Steel Containers Round-Top		167
FGR1530E	RD	Steel Containers Round-Top		167
FGR1530E	SPGN	Steel Containers Round-Top		167
FGR1530E	WH	Steel Containers Round-Top		167
FGR1536	SBBR	Crowne Steel Container Round-Top		162
FGR1536	SCGR	Crowne Steel Container Round-Top		162
FGR1536	BK	Metallic Steel Container Round-Top		163
FGR1536	CR	Metallic Steel Container Round-Top		163
FGR1536	EGN	Metallic Steel Container Round-Top		163
FGR1536	ANT	Metallic Steel Container Round-Top		163
FGR1536	SSS	Metallic Steel Container Round-Top		164
FGR1536	SBS	Metallic Steel Container Round-Top		164
FGR1536	MC	Metallic Steel Container Round-Top		164
FGR1536	SM	Steel Container Round-Top		167
FGR1536E	AL	Steel Container Round-Top		167
FGR1536E	BK	Steel Container Round-Top		167
FGR1536E	COB	Steel Container Round-Top		167

Part	Color	Description	UPC	Page
FGR1536E	RD	Steel Container Round-Top		167
FGR1536E	SPGN	Steel Container Round-Top		167
FGR1536E	WH	Steel Container Round-Top		167
FGR1536E0T	BK	Steel Container Open-Top		167
FGR1536STE	SM	Stepmaster™ Round-Top		167
FGR1536STE	WH	Stepmaster™ Round-Top		167
FGR1639E	HBZ	Aladdin Smokers' Station®	097591102961	200
FGR1639E	HGR	Aladdin Smokers' Station®	097591395660	200
FGR18	201	Aspen Ash/Trash		187
FGR1842E	WH	Steel Container Round-Top		167
FGR18SU	201	Aspen Ash/Trash		187
FGR18SU	202	Aspen Ash/Trash		187
FGR18SU	2000	Aspen Ash/Trash		187
FGR18SU	6000	Aspen Ash/Trash		187
FGR18WU	500	Dimension 500 Ash/Trash w/ Weather Urn		186
FGR18WU	201	Aspen Ash/Trash w/ Weather Urn		187
FGR18WU	202	Aspen Ash/Trash w/ Weather Urn		187
FGR18WU	2000	Aspen Ash/Trash w/ Weather Urn		187
FGR18WU	6000	Aspen Ash/Trash w/ Weather Urn		187
FGR2030	SS	Eclipse Open-Top		159
FGR2030E	BK	Eclipse Open-Top		159
FGR2350	EGN	Regent 50 Series Flat Top		190
FGR235U50	EGN	Regent 50 Series Ash/Trash		190
FGR25T50	EGN	Regent 50 Series Round-Top		190
FGR32	SSS	Metallic Steel Container Open-Top		164
FGR32	SBS	Metallic Steel Container Open-Top		164
FGR32E	BK	Steel Container Round-Top		167
FGR32E	WH	Steel Container Round-Top		167
FGR34HT50	EGN	Regent 50 Series Hinged Top		190
FGR34HTWU50	EGN	Regent 50 Series Hinged Top w/ Weather Urn		190
FGR36HT	SBK	Dimension Series Hinged Top		186
FGR36HT	500	Dimension Series Hinged Top		186
FGR36HT	201	Aspen Hinged Top		187
FGR36HT	202	Aspen Hinged Top		187
FGR36HT	2000	Aspen Hinged Top		187
FGR36HT	6000	Aspen Hinged Top		187
FGR36HTWU	SBK	Dimension Series Hinged Top w/ Weather Urn		186
FGR36HTWU	500	Dimension Series Hinged Top w/ Weather Urn		186
FGR36HTWU	201	Aspen Hinged Top w/ Weather Urn		187
FGR36HTWU	202	Aspen Hinged Top w/ Weather Urn		187
FGR36HTWU	2000	Aspen Hinged Top w/ Weather Urn		187
FGR36HTWU	6000	Aspen Hinged Top w/ Weather Urn		187
FGR38HT	SBK	Dimension Series Hinged Top		186
FGR38HT	500	Dimension Series Hinged Top		186
FGR38HT	201	Aspen Hinged Top		187
FGR38HT	202	Aspen Hinged Top		187
FGR38HT	2000	Aspen Hinged Top		187
FGR38HT	6000	Aspen Hinged Top		187
FGR38HTWU	SBK	Dimension Series Hinged Top w/ Weather Urn		186
FGR38HTWU	500	Dimension Series Hinged Top w/ Weather Urn		186
FGR38HTWU	201	Aspen Hinged Top w/ Weather Urn		187
FGR38HTWU	202	Aspen Hinged Top w/ Weather Urn		187
FGR38HTWU	2000	Aspen Hinged Top w/ Weather Urn		187
FGR38HTWU	6000	Aspen Hinged Top w/ Weather Urn		187
FGR38SD	201	Aspen Side Door w/ Cam Lock		187
FGR40	SBK	Dimension Series Urn		186
FGR40	201	Aspen Urn		187
FGR40	202	Aspen Urn		187
FGR40	2000	Aspen Urn		187
FGR40	6000	Aspen Urn		187
FGR40WU	SBK	Dimension Series Urn w/ Weather Shield		186
FGR40WU	500	Dimension Series Urn w/ Weather Shield		186
FGR40WU	201	Aspen Urn w/ Weather Shield		187
FGR40WU	202	Aspen Urn w/ Weather Shield		187
FGR40WU	2000	Aspen Urn w/ Weather Shield		187
FGR40WU	6000	Aspen Urn w/ Weather Shield		187
FGR41	SBK	Dimension Series Ash/Trash		186
FGR41	201	Aspen Ash/Trash		187
FGR41	202	Aspen Ash/Trash		187
FGR41	2000	Aspen Ash/Trash		187
FGR41	6000	Aspen Ash/Trash		187
FGR41WU	SBK	Dimension Series Ash/Trash w/ Weather Shield		186
FGR41WU	500	Dimension Series Ash/Trash w/ Weather Shield		186
FGR41WU	201	Aspen Ash/Trash w/ Weather Shield		187
FGR41WU	202	Aspen Ash/Trash w/ Weather Shield		187
FGR41WU	2000	Aspen Ash/Trash w/ Weather Shield		187
FGR41WU	6000	Aspen Ash/Trash w/ Weather Shield		187
FGR442188		Digital Timer	086876203467	271
FGR442188		Compact Digital Timer	086876203974	271
FGR48HT	SBK	Dimension Series Hinged Top		186
FGR48HT	500	Dimension Series Hinged Top		186
FGR48HT	201	Aspen Hinged Top		187
FGR48HT	202	Aspen Hinged Top		187
FGR48HT	2000	Aspen Hinged Top		187
FGR48HT	6000	Aspen Hinged Top		187
FGR48HTWU	SBK	Dimension Series Hinged Top w/ Weather Urn		186
FGR48HTWU	500	Dimension Series Hinged Top w/ Weather Urn		186
FGR48HTWU	201	Aspen Hinged Top w/ Weather Urn		187

1 FedEx shippable items.

* Contact Customer Service for UPC information not provided.

Part	Color	Description	UPC	Page
FGR48HTWU	202	Aspen Hinged Top w/ Weather Urn		187
FGR48HTWU	2000	Aspen Hinged Top w/ Weather Urn		187
FGR48HTWU	6000	Aspen Hinged Top w/ Weather Urn		187
FGR5650	EGN	Regent 50 Series Flat Top		190
FGR565U50	EGN	Regent 50 Series Ash/Trash		190
FGR80DC		Refrigerator/Freezer		271
FGR80GC		Refrigerator/Freezer		271
FGR93400	BK	Metropolitan Smokers' Station	086876194371	197
FGR93400	SM	Metropolitan Smokers' Station	086876194388	197
FGS21600	GY00	Wall Washer Kit Includes 1 Wood Handle, 1 Plastic Head, 2 Cotton Pads		92
FGS22600	GY00	Wall Washer Kit Includes 1 Aluminum Handle, 1 Plastic Head, 2 Cotton Pads		92
FGS25	White	White Silica Sand		191
FGS29900	WH00	Wall Washer Replacement Pads, Launderable Cotton		92
FGS3EG	BK	Classics Recycle Receptacle		185
FGS3EP	BK	Classics Recycle Receptacle		185
FGS3ET	BK	Classics Drop Top w/ Levelers		185
FGS3ET	HBZ	Classics Drop Top w/ Levelers		185
FGS3ET	HGR	Classics Drop Top w/ Levelers		185
FGS3ET	SM	Classics Drop Top w/ Levelers		185
FGS3SSG	BK	Classics Recycle Receptacle		185
FGS3SSP	BK	Classics Recycle Receptacle		185
FGS3SST	BK	Classics Drop Top w/ Levelers	097591107096	185
FGS3SST	SS	Classics Drop Top w/ Levelers		185
FGS5SET	BK	Classics Drop Top w/ Levelers	097591106693	185
FGS5SET	SM	Classics Drop Top w/ Levelers		185
FGS5SETWS	BK	Classics Drop Top w/ Levelers and Weather Shield		185
FGS5SST	BK	Classics Drop Top w/ Levelers	097591107133	185
FGS5SST	SS	Classics Drop Top w/ Levelers		185
FGS5SSTWS	BK	Classics Drop Top w/ Levelers and Weather Shield		185
FGSBR52	GALV	Street Basket		195
FGSBR52	BK	Street Basket		195
FGSBR52	COB	Street Basket		195
FGSBR52	GRN	Street Basket		195
FGSBR52	RD	Street Basket		195
FGSC10	SS	Silhouettes Open-Top Square Receptacle		157
FGSC10E	TBK	Silhouettes Open-Top Square Receptacle		157
FGSC14	SS	Silhouettes Open-Top Square Receptacle		157
FGSC14E	TBK	Silhouettes Open-Top Square Receptacle		157
FGSC14E	DP	Silhouettes Open-Top Square Receptacle		157
FGSC14E	SM	Silhouettes Open-Top Square Receptacle		157
FGSC18	SS	Silhouettes Open-Top Square Receptacle		157
FGSC18E	TBK	Silhouettes Open-Top Square Receptacle		157
FGSC18E	DP	Silhouettes Open-Top Square Receptacle		157
FGSC18E	SM	Silhouettes Open-Top Square Receptacle		157
FGSC22	SS	Silhouettes Open-Top Square Receptacle		157
FGSC22E	TBK	Silhouettes Open-Top Square Receptacle		157
FGSC22E	DP	Silhouettes Open-Top Square Receptacle		157
FGSC22E	SM	Silhouettes Open-Top Square Receptacle		157
FGSCSU	TBK	Silhouettes Square Sand Urn	097591107171	157
FGSCSU	SS	Silhouettes Square Sand Urn	097591107188	157
FGSH12	SS	Silhouettes Half Round Trash Open-Top		156
FGSM1	BLA	Street Media 2 Panel, Perforated Sides		195
FGSM7	BLA	Street Media Complete Graphic Wrap		195
FGSO12	BK	European Half Round Trash Open-Top		163
FGSO12	SSS	Metallic Steel Container Half Round Trash Open-Top		164
FGSO16	BK	European Flat Top		163
FGSO16	CR	European Flat Top		163
FGSO16	EGN	European Flat Top		163
FGSO16	ANT	European Flat Top		163
FGSO16	SSS	Metallic Steel Container Flat Top		164
FGSO16	SBS	Metallic Steel Container Flat Top		164
FGSO16E	AL	Steel Containers Flat Top		167
FGSO16SU	BK	European Sand Top Ash/Trash		163
FGSO16SU	CR	European Sand Top Ash/Trash		163
FGSO16SU	EGN	European Sand Top Ash/Trash		163
FGSO16SU	ANT	European Sand Top Ash/Trash		163
FGSO16SU	SSS	Ash/Trash		164
FGSO16SU	SBS	Ash/Trash		164
FGSO16SUE	AL	Steel Container Ash/Trash		167
FGSO17	SBBR	Crowne Collection Flat Top	097591395974	162
FGSO17	SCGR	Crowne Collection Flat Top	097591395981	162
FGSO17SU	SCGR	Crowne Collection Ash/Trash	097591045282	162
FGSO17SU	SBBR	Crowne Collection Ash/Trash	097591045299	162
FGSO8	BK	European Half Round		163
FGSO8	CR	European Half Round		163
FGSO8	EGN	European Half Round		163
FGSO8	ANT	European Half Round		163
FGSO8	SSS	Metallic Half Round		164
FGSO8	SBS	Metallic Half Round		164
FGSO8SU	BK	European Half Round Ash/Trash		163
FGSO8SU	CR	European Half Round Ash/Trash		163
FGSO8SU	ANT	European Half Round Ash/Trash		163
FGSO8SU	SSS	Metallic Half Round Ash/Trash		164

¹ FedEx shippable items.

Part	Color	Description	UPC	Page
FGS08SU	SBS	Metallic Half Round Ash/Trash		164
FGSR14	SS	Silhouettes Small Rectangular Waste Receptacle		157
FGSR14E	TBK	Silhouettes Small Rectangular Waste Receptacle		157
FGSR14E	DP	Silhouettes Small Rectangular Waste Receptacle		157
FGSR14E	SM	Silhouettes Small Rectangular Waste Receptacle		157
FGSR18	SS	Silhouettes Large Rectangular Waste Receptacle		157
FGSR18E	TBK	Silhouettes Large Rectangular Waste Receptacle		157
FGSR18E	DP	Silhouettes Large Rectangular Waste Receptacle		157
FGSR18E	SM	Silhouettes Large Rectangular Waste Receptacle		157
FGSSIG		Smokers' Station® Wall-Mount In-Ground Pole w/ Hardware for FGR1012		201
FGSSSM		Smokers' Station® Wall-Mount/Surface-Mount Pole w/ Hardware for FGR1012		201
FGST12	SS	The Defenders® Step Can		143
FGST12E	RD	The Defenders® Step Can		143
FGST12E	WH	The Defenders® Step Can		143
FGST24	SS	The Defenders® Step Can		143
FGST24E	RD	The Defenders® Step Can		143
FGST24E	WH	The Defenders® Step Can		143
FGST35	SS	The Defenders® Step Can		143
FGST35E	RD	The Defenders® Step Can		143
FGST35E	WH	The Defenders® Step Can		143
FGST40	SS	The Defenders® Step Can w/ Wheels		143
FGST40E	RD	The Defenders® Step Can		143
FGST40E	WH	The Defenders® Step Can		143
FGST40EW	RD	The Defenders® Step Can		143
FGST40EW	WH	The Defenders® Step Can		143
FGST40SW	SS	The Defenders® Step Can w/ Wheels		143
FGST5E	WH	The Defenders® Step Can	097591075401	143
FGST5E	RD	The Defenders® Step Can	097591075432	143
FGST7	SS	The Defenders® Step Can		143
FGST7E	RD	The Defenders® Step Can		143
FGST7E	WH	The Defenders® Step Can		143
FGT11000	GY00	Overhead Dusting Tool with Launderable Head, 51" l (129.5 cm) Extension Handle	086876125894	58
FGT12000	GY00	Overhead Dusting Tool with Angled Launderable Head, 51" l (129.5 cm) Extension Handle	086876125931	58
FGT13000	GY00	Overhead Dusting Tool with Launderable Head, 8½" l (2.6 m) Extension Handle	086876125955	58
FGT1414	SS	WasteMaster Hinged Top		146
FGT1414E	WH	WasteMaster Hinged Top		146
FGT1424	SS	WasteMaster Hinged Top		146
FGT1424E	WH	WasteMaster Hinged Top		146
FGT1940	SS	WasteMaster Hinged Top		146
FGT1940E	WH	WasteMaster Hinged Top		146
FGT19900	WH00	Overhead Dusting Tool Replacement Head fits FGT11000, FGT12000, FGT13000	086876125979	58
FGT20006	WH00	Nylon Finish Mop		74
FGT20106	WH00	Nylon Finish Mop		74
FGT25500	WH00	Rough Floor Wet Mop		73
FGT25600	WH00	Rough Floor Wet Mop		73
FGT30000	WH00	Clean Room Mop		73
FGT30100	WH00	Clean Room Mop		73
FGT41000	0000	Flexible Head Overhead Dusting Tool, Flexible Head with 60" l (152.4 cm) Aluminum Handle	086876050905	58
FGT49900	WH00	Dust Mitt Off-Floor Dusting Tool, Cotton	086876050912	58
FGT81206	GR00	Web Foot® Microfiber Tube Mop		66
FGT81306	GR00	Web Foot® Microfiber Tube Mop		66
FGT85206	GR00	Web Foot® Microfiber Tube Mop		66
FGT85306	GR00	Web Foot® Microfiber Tube Mop		66
FGTHB212DSP		Dishwasher-Safe Meat Thermometer, 1½" Dial		271
FGTHBP		Type K Thermocouple – Burger Probe		269
FGTHC400DS		Dishwasher-Safe Candy Thermometer		271
FGTHG600		Grill		271
FGTHM200DS		Dishwasher-Safe Meat Thermometer, 2½" Dial		271
FGTHMP		Type K Thermocouple – Microtip Probe		269
FGTHO550		Oven Thermometer		271
FGTHOP		Type K Thermocouple – Oven Probe		269
FGTHP160DS		Dishwasher-Safe Pocket Thermometer		270
FGTHP220C		Pocket Thermometer		270
FGTHP220DS		Dishwasher-Safe Pocket Thermometer		270
FGTHP302L		Digital Pocket		270
FGTHP550DS		Dishwasher-Safe Pocket Thermometer		270
FGTHR80C		Refrigerator/Freezer (carded blister)		271
FGTHR80P		Refrigerator/Freezer (non-carded)		271
FGTHW180		Warming/Proofing		271
FGTMP1000		Digital Pocket		270
FGTMP2000		Thermocouple		269
FGTMP500		Pocket Infrared Thermometer		270
FGU11000	0000	Wedge Mop Handle and Frame, Wood Handle with Metal Frame		83
FGU12000	YL00	Trapper® Wedge Mop Dust Mop Head, Looped-End		83
FGU13000	WH00	Kut-A-Way® Wedge Mop Dust Mop Head, Cut-End		83
FGU13067	WH00	Kut-A-Way® Wedge Mop Kit, Contains FGU13000 Mop, FGU11000 Handle and Frame		83

* Contact Customer Service for UPC information not provided.

Part	Color	Description	UPC	Page
FGU21000	WH00	Laundry Net, Synthetic Mesh Bag with Locking Closure		76
FGU650	SA	Smokers' Station® Wall-Mount Urn		201
FGU718	MC	Smokers' Station® Wall-Mount Urn		201
FGUB1900	BK	Steel Wastebasket Open-Top	097591058589	163
FGUB1900	SSS	Metallic Steel Open-Top		164
FGUB1900E	BK	Steel Receptacle Open-Top		167
FGV11600	WH00	Economy Cotton Mop		74
FGV11700	WH00	Economy Cotton Mop		74
FGV11800	WH00	Economy Cotton Mop		74
FGV11900	WH00	Economy Cotton Mop		74
FGV15600	WH00	Economy Cotton Mop		74
FGV15700	WH00	Economy Cotton Mop		74
FGV15800	WH00	Economy Cotton Mop		74
FGV15900	WH00	Economy Cotton Mop		74
FGV41600	WH00	Economy Rayon Cut-End Mop		74
FGV41700	WH00	Economy Rayon Cut-End Mop		74
FGV41800	WH00	Economy Rayon Cut-End Mop		74
FGV41900	WH00	Economy Rayon Cut-End Mop		74
FGV46900	WH00	Economy Bolt-On Rayon Cut-End Mop		74
FGWB2029	AL	Steel Open-Top Wastebasket		145
FGWB2029	BK	Steel Open-Top Wastebasket		145
FGWB2029	GR	Steel Open-Top Wastebasket		145
FGWB26	AL	Steel Open-Top Wastebasket		145
FGWB26	BK	Steel Open-Top Wastebasket		145
FGWB26	GR	Steel Open-Top Wastebasket		145
FGWB29R	SS	Concept Collection™ Open-Top Wastebasket		165
FGWB30R	AL	Steel Open-Top Wastebasket		145
FGWB30R	BK	Steel Open-Top Wastebasket		145
FGWB30R	GR	Steel Open-Top Wastebasket		145
FGWB44	AL	Steel Open-Top Wastebasket		145
FGWB44	BK	Steel Open-Top Wastebasket		145
FGWB44	GR	Steel Open-Top Wastebasket		145
FGWB96R	AL	Steel Open-Top Wastebasket		145
FGWB96R	BK	Steel Open-Top Wastebasket		145
FGWB96R	GR	Steel Open-Top Wastebasket		145
FGWHB14	SS	Hide-A-Bag Open-Top Wastebasket		165
FGWHB14E	BK	Hide-A-Bag Open-Top Wastebasket		165
FGWMB20	BK	Concept Collection™ Open-Top Wastebasket	097591080061	165
FGWMB20	SL	Concept Collection™ Open-Top Wastebasket	097591080078	165
FGWMB30R	BK	Concept Collection™ Open-Top Wastebasket		165
FGX40204	0000	Plastic Foam Block Brace Broom, Medium-Duty, Multisurface Polypropylene Fill, Fine Flagged Border		89
FGX40804	0000	Plastic Foam Block Brace Broom, Heavy-Duty, Coarse Polypropylene Fill		89
FGY16R		Mechanical Portion Control Scale		267
FGY200R		Mechanical Portion Control Scale		267
FGY32R		Mechanical Portion Control Scale		267
FGY50		Mechanical Portion Control Scale		267
FGYG1000R		Mechanical Portion Control Scale – Metric		267
FGYG180R		Mechanical Portion Control Scale		267
FGYG400R		Mechanical Portion Control Scale		267
FGYG425R		Mechanical Portion Control Scale		267
FGYG450R		Mechanical Portion Control Scale		267
FGYG500R		Mechanical Portion Control Scale – Metric		267
FGYG800R		Mechanical Portion Control Scale		267
M1564200		Wheel for FG564200, FG564261		238
M1565400		Wheel for FG565461		238
M1565800		Wheel for FG565861		239
M1565900		Wheel for FG565961		239
M1566000		Wheel for FG566000, FG566061		238
M1566200		Wheel for FG566261		238
MT60F88		Mechanical Timer		271
NPS65804		Wheelbarrow Handle Kit (2 wood handles), fits FG565861 and FG565961		239

¹ FedEx shippable items.

* Contact Customer Service for UPC information not provided.

Fits	Part Number	Description	Page #
1792339	256R-L2	Glutton® Square Insert (BLUE)	149
1792339	256R-L3	Glutton® Paper Insert (BLUE)	149
1792339	256R-L4	Glutton® Circle Insert (BLUE)	149
1792339	256R-L5	Glutton® Triangle Insert (BLUE)	149
1792339	256T-L1	Replacement Lid Frame for 2-Stream Glutton® (BLUE)	149
1792340	256R-L2	Glutton® Square Insert (DGRN)	149
1792340	256R-L3	Glutton® Paper Insert (DGRN)	149
1792340	256R-L4	Glutton® Circle Insert (DGRN)	149
1792340	256R-L5	Glutton® Triangle Insert (DGRN)	149
1792340	256T-L1	Replacement Lid Frame for 2-Stream Glutton® (DGRN)	149
1792371	1792338	Glutton® 1-Stream Recycle Insert (BEIG)	149
1792371	256R-L2	Glutton® Square Insert (BEIG)	149
1792371	256R-L3	Glutton® Paper Insert (BEIG)	149
1792371	256R-L4	Glutton® Circle Insert (BEIG)	149
1792371	256R-L5	Glutton® Triangle Insert (BEIG)	149
1792371	256T-L1	Replacement Lid Frame for 2-Stream Glutton® (BEIG)	149
1792372	256R-L2	Glutton® Square Insert (BLUE)	149
1792372	256R-L3	Glutton® Paper Insert (BLUE)	149
1792372	256R-L4	Glutton® Circle Insert (BLUE)	149
1792372	256R-L5	Glutton® Triangle Insert (BLUE)	149
1792373	256R-L2	Glutton® Square Insert (DGRN)	149
1792373	256R-L3	Glutton® Paper Insert (DGRN)	149
1792373	256R-L4	Glutton® Circle Insert (DGRN)	149
1792374	256R-L3	Glutton® Paper Insert (BLUE)	149
1792374	256R-L3	Glutton® Paper Insert (DGRN)	149
1792374	1792338	Glutton® 1-Stream Recycle Insert (BEIG)	149
1792374	1792338	Glutton® 1-Stream Recycle Insert	149
1792374	256R-L2	Glutton® Square Insert (BEIG)	149
1792374	256R-L3	Glutton® Paper Insert (BEIG)	149
1792374	256R-L4	Glutton® Circle Insert (BEIG)	149
1792374	256R-L5	Glutton® Triangle Insert (BEIG)	149
1861427	6173-M1	Polyliner Holder	98
1861427	9173-L2	Top Shelf	98
1861427	9173-L3	Middle Shelf	98
1861427	9173-L4	Base	98
1861427	9173-L5	Handle	98
1861427	9173-L6	Aluminum Upright	98
1861427	9173-L8	Folding Bag/Bucket Platform	98
1861427	9173-M1	Quiet Wheel and Axle Parts	98
1861427	9173-M2	Lock and Key	98
1861427	9173-M4	Tool Grip Rack and Cap	98
1861427	9173-M5	Rubber Tool Grip	98
1861427	9173-M6	Handle Tool Grip Cap	98
1861427	9194-M1	8" Ballbearing Wheel Kit	98
1861429	3424-L6	4" dia (10.2 cm) Swivel Caster	99
1861429	6173-M1	Polyliner Holder	99
1861429	9173-L2	Top Shelf	99
1861429	9173-L3	Middle Shelf	99
1861429	9173-L4	Base	99
1861429	9173-L5	Handle	99
1861429	9173-L6	Aluminum Upright	99
1861429	9173-L9	Wheel/Axle Parts	99
1861429	9173-M4	Tool Grip Rack and Cap	99
1861429	9173-M5	Rubber Tool Grip	99
1861429	9173-M6	Handle Tool Grip Cap	99
1861429	9194-M1	8" Ballbearing Wheel Kit	99
1861429	9194-M2	Vacuum Restraint Kit	99
1861430	6173-L1	4" dia Caster	99
1861430	6173-L9	Wheel and Axle Parts	99
1861430	6173-M0	Back Upright for Cleaning Cart (Specify Color)	99
1861430	6173-M4	Bottom Shelf for Cleaning Cart (Specify Color)	99
1861430	6173-M5	Handle for Cleaning Cart Trolley (Specify Color)	99
1861430	6173-M6	Left Side Upright for Cleaning Cart (Specify Color)	99
1861430	6173-M7	Right Side Upright for Cleaning Cart (Specify Color)	99
1861430	6173-M8	Top Shelf for Cleaning Cart (Specify Color)	99
1861430	6173-M9	Middle Shelf for Cleaning Cart (Specify Color)	99
1861443	6181-L2	Lock and Key	99
1863896	7570-L2	3" dia (7.6 cm) Caster	60
1863897	7570-L2	3" dia (7.6 cm) Caster	60
1863898	7570-L2	3" dia (7.6 cm) Caster	60
1863898	7575-L5	Handle	60
1863898	7575-L7	Pan Head Screws (4)	60
1863898	7575-L8	Gear Pack/P Plates (Set of 2)	60
1863898	7575-M2	Spring	60
1863899	7570-L2	3" dia (7.6 cm) Caster	60
1863899	7575-L5	Handle	60
1863899	7575-L7	Pan Head Screws (4)	60
1863899	7575-L8	Gear Pack/P Plates (Set of 2)	60
1863899	7575-M2	Spring	60
1868433	BP06-L1	50" Power Ext. Cord	112
1868433	BP06-L2	Backpack Motor Assembly	112
1868434	BP06-L1	50" Power Ext. Cord	112
1868434	BP06-L2	Backpack Motor Assembly	112
1868435	BP06-L1	50" Power Ext. Cord	112
1868435	BP06-L2	Backpack Motor Assembly	112
1868436	CV12-L2	CV Motor/Fan Assembly	115
1868437	CV12-L2	CV Motor/Fan Assembly	115

Fits	Part Number	Description	Page #
1868438	PH12-L1	PH Handle Assembly w/ Cord	114
1868438	PH12-L2	PH Motor Assembly	114
1868439	PH12-L2	PH Motor Assembly	114
1868440	MH12-L1	MH Handle Assembly w/ Cord	114
1868440	MH12-L2	MH Motor Assembly	114
1868621	MH12-L1	MH Handle Assembly w/ Cord	114
1868621	MH12-L2	MH Motor Assembly	114
1868622	UL12-L1	40" Power Ext. Cord	115
1868622	UL12-L2	UL Complete Motor Assembly	115
FG101100	1011-L1	12" dia (30.5 cm) Nonmarking Wheel	231
FG101100	1011-L2	4" dia (10.2 cm) Nonmarking Plate Caster	231
FG101300	1013-L1	12" dia (30.5 cm) Wheel	231
FG101300	1013-L2	4" dia (10.2 cm) Caster	231
FG102500	1025-L1	1 1/2 cu yd (1.1 m³) Body ONLY	232
FG102500	1025-L4	4" dia (10.2 cm) Swivel Caster	232
FG102500	1025-L5	1 1/2 cu yd (1.1 m³) Std-Duty Tilt Truck Frame (Specify Color)	232
FG102500	1025-L6	12" dia (30.5 cm) Wheel	232
FG102600	1025-L1	1 1/2 cu yd (1.1 m³) Body ONLY	232
FG102600	1025-L4	4" dia (10.2 cm) Swivel Caster	232
FG102600	1026-L5	1 1/2 cu yd (1.1 m³) Heavy-Duty Tilt Truck Frame w/ Side Rails (Specify Color)	232
FG102600	1026-L6	12" dia (30.5 cm) Wheel (Specify Color)	232
FG102641	1026-L7	16" dia (40.6 cm) Wheel	233
FG102641	1316-L4	Hitch (Specify Color)	233
FG102641	4727-L3	6" dia (15.2 cm) Swivel Caster	233
FG103500	1025-L4	4" dia (10.2 cm) Swivel Caster	232
FG103500	1026-L6	12" dia (30.5 cm) Wheel	232
FG103500	1035-L1	2 cu yd (1.5 m³) Body ONLY	232
FG103500	1035-L5	2 cu yd (1.5 m³) Std-Duty Tilt Truck Frame (Specify Color)	232
FG103600	1025-L4	4" dia (10.2 cm) Swivel Caster	232
FG103600	1026-L6	12" dia (30.5 cm) Wheel	232
FG103600	1035-L1	2 cu yd (1.5 m³) Body ONLY	232
FG103600	1036-L5	2 cu yd (1.5 m³) Heavy-Duty Tilt Truck Frame (Specify Color)	232
FG104500	1025-L4	4" dia (10.2 cm) Swivel Caster	232
FG104500	1026-L6	12" dia (30.5 cm) Wheel	232
FG104500	1045-L1	2 1/2 cu yd (1.9 m³) Body ONLY	232
FG104500	1045-L5	2 1/2 cu yd (1.9 m³) Std-Duty Tilt Truck Frame (Specify Color)	232
FG104600	1025-L4	4" dia (10.2 cm) Swivel Caster	232
FG104600	1026-L6	12" dia (30.5 cm) Wheel	232
FG104600	1045-L1	2 1/2 cu yd (1.9 m³) Body ONLY	232
FG104600	1046-L5	2 1/2 cu yd (1.9 m³) Heavy-Duty Tilt Truck Frame w/ Side Rails (Specify Color)	232
FG105400	1054-L1	1/2 cu yd (.4 m³) Body ONLY	234
FG105443	1054-L1	1/2 cu yd (.4 m³) Body ONLY	234
FG105443	1054-L2	1/2 cu yd Tilt Truck Body (Specify Color)	234
FG105443	1054-L4	6" dia (15.2 cm) Swivel Caster	234
FG105443	1054-L5	6" dia (15.2 cm) Rigid Caster	234
FG105900	1059-L1	1 cu yd (.8 m³) Body ONLY	234
FG105943	1054-L4	6" dia (15.2 cm) Swivel Caster	234
FG105943	1054-L5	6" dia (15.2 cm) Rigid Caster	234
FG105943	1059-L1	1 cu yd (.8 m³) Body ONLY	234
FG106400	1025-L1	1 1/2 cu yd (1.1 m³) Body ONLY	234
FG106443	1054-L4	6" dia (15.2 cm) Swivel Caster	234
FG106443	1054-L5	6" dia (15.2 cm) Rigid Caster	234
FG106900	1035-L1	2 cu yd (1.5 m³) Body ONLY	234
FG106943	1054-L4	6" dia (15.2 cm) Swivel Caster	234
FG106943	1054-L5	6" dia (15.2 cm) Rigid Caster	234
FG107400	1045-L1	2 1/2 cu yd (1.9 m³) Body ONLY	234
FG107443	1054-L4	6" dia (15.2 cm) Swivel Caster	234
FG107443	1054-L5	6" dia (15.2 cm) Rigid Caster	234
FG1100	L1100	Plastic Liner	163, 164
FG1219	L1227	Plastic Liner	
FG1227	L1227	Plastic Liner	
FG13	L13	Plastic Liner	38
FG130400	1004-L3	10" (25.4 cm) Wheel	232
FG130400	1304-L1	1/2 cu yd (.4 m³) Utility and Std Tilt Truck Body ONLY	232
FG130400	1304-L2	1/2 cu yd (.4 m³) Utility Frame* (Specify Color)	232
FG130400	1304-L3	4" dia (10.2 cm) Swivel Caster	232
FG130500	1005-L4	3.5" (8.9 cm) Caster	232
FG130500	1304-L1	1/2 cu yd (.4 m³) Utility and Std Tilt Truck Body ONLY	232
FG130500	1305-L2	1/2 cu yd Std and Heavy-Duty Tilt Truck Frame (Specify Color)	232
FG130500	1305-L3	10" dia (25.4 cm) Wheel	232
FG130500	1305-L4	Handle for 1/2 cu yd and 1 cu yd Tilt Trucks (Specify Color)	232
FG130573	1305-L3	10" dia (25.4 cm) Wheel	224
FG130573	1305-L4	Handle (Specify Color)	232
FG130600	1005-L4	3.5" dia (8.9 cm) Caster	232
FG130600	1305-L2	1/2 cu yd Std and Heavy-Duty Tilt Truck Frame (Specify Color)	232
FG130600	1305-L4	Handle for 1/2 cu yd and 1 cu yd Tilt Trucks (Specify Color)	232
FG130600	1306-L1	1/2 cu yd (.4 m³) Heavy-Duty Tilt Truck Body ONLY	232
FG130600	1306-L3	10" dia (25.4 cm) Wheel	232

* 3 Week Lead Time

Fits	Part Number	Description	Page #
FG130641	1305-L4	Handle for 1/2 cu yd and 1 cu yd Tilt Trucks (Specify Color)	233
FG130641	1316-L4	Hitch	233
FG130641	4727-L3	6" dia (15.2 cm) Swivel Caster	233
FG130641	9T06-L1	16" Pneumatic Wheel	233
FG131400	1014-L3	12" dia (30.5 cm) Wheel	232
FG131400	1305-L4	Handle for 1/2 cu yd and 1 cu yd Tilt Trucks (Specify Color)	232
FG131400	1314-L1	1 cu yd (.8 m³) Utility and Std-Duty Tilt Truck Body ONLY	232
FG131400	1314-L2	1 cu yd (.8 m³) Utility Duty Tilt Truck Frame (Specify Color)	232
FG131400	1314-L3	1 cu yd (.8 m³) Utility Duty Tilt Truck Caster	232
FG131500	1305-L4	Handle for 1/2 cu yd and 1 cu yd Tilt Trucks (Specify Color)	232
FG131500	1314-L1	1 cu yd (.8 m³) Utility and Std-Duty Tilt Truck Body ONLY (Specify Color)	232
FG131500	1315-L2	1 cu yd (.8 m³) Std and Heavy-Duty Tilt Truck Frame (Specify Color)	232
FG131500	1315-L3	12" dia (30.5 cm) Wheel	232
FG131500	4402-L1	5" dia (12.7 cm) Swivel Caster	232
FG131542	1305-L4	Handle for 1/2 cu yd and 1 cu yd Tilt Trucks (Specify Color)	233
FG131542	1315-L3	12" dia (30.5 cm) Wheel	233
FG131600	1305-L4	Handle for 1/2 cu yd and 1 cu yd Tilt Trucks (Specify Color)	232
FG131600	1315-L2	1 cu yd (.8 m³) Std and Heavy-Duty Tilt Truck Frame (Specify Color)	232
FG131600	1316-L1	1 cu yd (.8 m³) Heavy-Duty Tilt Truck Body ONLY	232
FG131600	1316-L2	5" dia (12.7 cm) Swivel Caster	232
FG131600	1316-L3	12" dia (30.5 cm) Wheel	232
FG131641	1305-L4	Handle for 1/2 cu yd and 1 cu yd Tilt Trucks (Specify Color)	233
FG131641	1316-L4	Hitch Kit	233
FG131641	4727-L3	6" dia (15.2 cm) Swivel Caster	233
FG131641	9T06-L1	16" Pneumatic Wheel	233
FG135	L135	Plastic Liner	38
FG16100111	9400-L1	Spigot Assembly	281
FG1628LO	355000GRAY	Plastic Liner	
FG1628LO	GL1536	Galvanized Liner	
FG1630	355000GRAY	Plastic Liner	
FG1630	GL1536	Galvanized Liner	
FG1630SQ	L140	Plastic Liner	
FG1639	355000GRAY	Plastic Liner	
FG1639	GL1536	Galvanized Liner	
FG1639DR	355000GRAY	Plastic Liner	
FG16830111	9400-L1	Spigot Assembly	281
FG1829	L1824	Plastic Liner	
FG1829	GL1824	Galvanized Liner	
FG1830ARLO	L1830	Plastic Liner	
FG1830LO	L1830	Plastic Liner	
FG1830SUT	L1824	Plastic Liner	
FG1837	L1824	Plastic Liner	
FG200	GL200	Galvanized Liner	140
FG2030SQ	L2434	Plastic Liner	
FG2030SQ	GL2434	Galvanized Liner	
FG2032	L2032	Plastic Liner	
FG2037SQ	L2434	Plastic Liner	
FG2037SQ	GL2434	Galvanized Liner	
FG2038SQ	L2434	Plastic Liner	
FG2038SQ	GL2434	Galvanized Liner	
FG2432	L2432BR	Plastic Liner	
FG2432	GL2432	Galvanized Liner	
FG2432AR	L2432BR	Plastic Liner	
FG2432SQ	L38	Plastic Liner	
FG2432SQ	GL38	Galvanized Liner	
FG2438	L2438	Plastic Liner	
FG2438SQ	L38	Plastic Liner	
FG2438SQ	GL38	Galvanized Liner	
FG2439	L2432BR	Plastic Liner	
FG2439	GL2432	Galvanized Liner	
FG2439DR	L2432BR	Plastic Liner	
FG2448SQ	L38	Plastic Liner	
FG2448SQ	GL38	Galvanized Liner	
FG2449SQ	L38	Plastic Liner	
FG2449SQ	GL38	Galvanized Liner	
FG252300	2523-L1	Stepstool Caster	120
FG252300	2523-L2	Top Pad	120
FG252300	2523-L3	Step Pad	120
FG253100	2531-L1	Lobby Pro® Dust Pan	94
FG253100	2531-L4	Lobby Pro® Dust Pan Wheel	94
FG253100	2532-L2	Lobby Pro® Dust Pan Handle	94
FG253200	2532-L1	Lobby Pro® Dust Pan Cover	94
FG253200	2532-L2	Lobby Pro® Dust Pan Handle	94
FG253200	2532-L3	Lobby Pro® Dust Pan	94
FG253300	2532-L3	Lobby Pro® Dust Pan	94
FG256L00	256-L1	Glutton® Bottle/Can Insert (Specify Color)	148
FG256W00	2646-L1	O-Ring for Glutton® Hold-Down Base	193
FG256W00	2646-L2	Anchor w/ O-Ring for Glutton® Hold-Down Base	193

Fits	Part Number	Description	Page #
FG256X00	256N-L1	Door ONLY for Glutton® Top (Specify Color, Top = 2 doors)	193
FG257088	2570-L4	Replacement Groundskeeper® Receptacle (Specify Color)	200
FG258500	2586-L1	Metal Liner for Smoking Urn	201
FG258600	2586-L1	Metal Liner for Smoking Urn	201
FG262400	2624-L1	20 U.S. gal (75.7 L) BRUTE® Container w/ drain holes for Greenskeeper®	262
FG262400	2624-L2	20 U.S. gal (75.7 L) BRUTE® Container w/ spigot hole for Greenskeeper®	262
FG262400	2624-L3	Spigot Kit for Greenskeeper®	262
FG263600	2624-L3	Spigot Kit for Greenskeeper®	262
FG263600	2636-L1	32 U.S. gal (121.1 L) BRUTE® Container w/ drain holes for Greenskeeper®	262
FG263600	2636-L2	32 U.S. gal (121.1 L) BRUTE® Container w/ spigot hole for Greenskeeper®	262
FG264043	2651-L2	3" dia (7.6 cm) Caster	130
FG264360	2643-L1	Soft Grip Handle	111, 128
FG264600	1011-L2	4" dia. (10.2 cm) Nonmarking Plate Caster	130
FG264600	6173-L9	Wheel and Axle Parts	130
FG265000	2650-L1	3" dia (7.6 cm) Swivel Plate Caster	130
FG265100	2651-L1	Hitch	130
FG265100	2651-L2	3" dia. (7.6 cm) Caster	130
FG265103	2651-L1	Hitch	130
FG265103	2651-L2	3" dia. (7.6 cm) Caster	130
FG266400	2664-L1	Door (Set) for the Untouchable® Swing Top (Specify Color)	137
FG267200	2779-L1	Door for Untouchable® Swing Top (Specify Color)	137
FG289000	2890-L2	Pint Insert for Condiment Dispenser (6)	280
FG289100	2891-L2	Quart Insert for Condiment Dispenser (3)	280
FG331500	3315-L1	Bracket Kit	275
FG331500	3315-L1	Bracket Kit	275
FG331500	3315-L2	Extrusion Kit	275
FG331500	3315-L3	Cutting Board for Max System™ Prep Cart	275
FG331500	3317-L1	Max System™ Caster and Hardware Kit (Specify Color)	275
FG331600	3316-L1	Extrusion Kit	275
FG331600	3316-L2	Cutting Board for Max System™ Prep Cart	275
FG331600	3317-L1	Max System™ Caster and Hardware Kit (Specify Color)	275
FG331700	3315-L1	Bracket Kit	275
FG331700	3315-L2	Extrusion Kit	275
FG331700	3317-L1	Max System™ Caster and Hardware Kit (Specify Color)	275
FG331700	3317-L2	Spanner Kit	275
FG331900	3315-L1	Bracket Kit	275
FG331900	3316-L1	Extrusion Kit	275
FG331900	3317-L1	Max System™ Caster and Hardware Kit (Specify Color)	275
FG331900	3319-L2	Spanner Kit	275
FG332000	3315-L1	Bracket Kit	275
FG332000	3317-L1	Max System™ Caster and Hardware Kit (Specify Color)	275
FG332000	3320-L1	Extrusion Kit	275
FG332000	3320-L2	Spanner Kit	275
FG332400	3315-L1	Bracket Kit	275
FG332400	3317-L1	Max System™ Caster and Hardware Kit (Specify Color)	275
FG332400	3324-L1	Extrusion Kit	275
FG332400	3324-L2	Spanner Kit	275
FG335588	3424-L6	4" dia (10.2 cm) Swivel Caster	226
FG335800	3358-L1	3 U.S. gal (11.4 L) Tank w/ threaded adapter and wing nut for Beverage Dispenser (Specify Color)	281
FG335800	3358-L5	Label/Spigot Kit for 3 and 5 U.S. gal (11.4 and 18.9 L) Beverage Dispenser	281
FG335800	3358-L6	Spigot for 3 and 5 U.S. gal (11.4 and 18.9 L) Beverage Dispenser	281
FG335800	3358-L7	Labels (1 Iced Tea and 1 Lemonade) for Beverage Dispenser	281
FG335800	3358-L8	Iced Coffee Label for Beverage Dispenser	281
FG335800	3358-L9	Lid for Beverage Dispenser	281
FG335800	3358-M1	Tray for Beverage Dispenser	281
FG335800	3358-M2	Base Assembly (Base w/tray slide) for Beverage Dispenser	281
FG335900	3358-L5	Label/Spigot Kit for 3 and 5 U.S. gal (11.4 and 18.9 L) Beverage Dispenser	281
FG335900	3358-L6	Spigot for 3 and 5 U.S. gal (11.4 and 18.9 L) Beverage Dispenser	281
FG335900	3358-L7	Labels (1 Iced Tea and 1 Lemonade) for Beverage Dispenser	281
FG335900	3358-L8	Iced Coffee Label for Beverage Dispenser	281
FG335900	3358-L9	Lid for Beverage Dispenser	281
FG335900	3358-M1	Tray for Beverage Dispenser	281
FG335900	3358-M2	Base Assembly (Base w/ tray slide) for Beverage Dispenser	281
FG335900	3359-L1	5 U.S. gal (18.9 L) Tank w/ threaded Adapter and Wing Nut for Beverage Dispenser	281
FG342100	3421-L1	Top Shelf for Utility Cart (Specify Color)	226
FG342100	3421-L2	Middle Shelf for Utility Cart (Specify Color)	226

Fits	Part Number	Description	Page #
FG342100	3421-L3	Bottom Shelf for Utility Cart (Specify Color)	226
FG342100	3421-L4	Handle for Utility Cart (Specify Color)	226
FG342100	3421-L5	End Panel for Utility Cart (Specify Color)	226
FG342100	3421-L6	3" dia (7.6 cm) Caster Kit (4 casters)	226
FG342488	3421-L1	Top Shelf for Utility Cart (Specify Color)	226, 277
FG342488	3421-L2	Middle Shelf for Utility Cart (Specify Color)	226, 277
FG342488	3421-L3	Bottom Shelf for Utility Cart (Specify Color)	226, 277
FG342488	3421-L4	Handle for Utility Cart (Specify Color)	226, 277
FG342488	3424-L6	4" dia (10.2 cm) Swivel Caster	226, 277
FG342488	3424-M2	Aluminum Extrusion for Utility Cart (8 Uprights)	226, 277
FG345700	3421-L1	Top Shelf for Utility Cart (Specify Color)	226
FG345700	3421-L2	Middle Shelf for Utility Cart (Specify Color)	226
FG345700	3421-L3	Bottom Shelf for Utility Cart (Specify Color)	226
FG345700	3421-L4	Handle for Utility Cart (Specify Color)	226
FG345700	3424-L6	4" dia (10.2 cm) Swivel Caster	226
FG353000	3530-L1	3" dia (7.6 cm) Caster	130, 244, 245
FG355188	3551-L1	Slim Jim® Trolley Caster	135, 147
FG355188	3551-L2	Slim Jim® Trolley Latch/Kick Plate	135, 147
FG355300	7570-L2	3" dia (7.6 cm) Caster	135, 147
FG360088	3600-L1	Body for Ingredient Mobile Bin	250
FG360088	3600-L4	3" dia (7.6 cm) Swivel Caster for Ingredient Mobile Bin	250
FG360088	3600-L5	3" dia (7.6 cm) Rigid Caster for Ingredient Mobile Bin	250
FG360100	3600-L3	Accessory Kit Labels and Instruction Sheet for Ingredient Mobile Bin	250
FG360100	3600-L4	3" dia (7.6 cm) Swivel Caster for Ingredient Mobile Bin	250
FG360100	3600-L5	3" dia (7.6 cm) Rigid Caster for Ingredient Mobile Bin	250
FG360100	3601-L1	Body for Ingredient Mobile Bin	250
FG360100	3601-L2	Front Lid/Back Lid for Ingredient Mobile Bin	250
FG360288	3600-L4	3" dia (7.6 cm) Swivel Caster for Ingredient Mobile Bin	250
FG360288	3600-L5	3" dia (7.6 cm) Rigid Caster for Ingredient Mobile Bin	250
FG360288	3602-L1	Body for Ingredient Mobile Bin	250
FG360388	3600-L4	3" dia (7.6 cm) Swivel Caster for Ingredient Mobile Bin	250
FG360388	3600-L5	3" dia (7.6 cm) Rigid Caster for Ingredient Mobile Bin	250
FG360388	3603-L1	Body for Ingredient Mobile Bin	250
FG396300	3963-L1	Tray Top Kit for Plaza® Container	193
FG396300	3964-L2	Molded Polyliner Holding Kit for Plaza® Container	193
FG396300	3964-L3	Latch Kit for Plaza® Container	193
FG396300	3964-L4	Refuse Door Replacement Kit for Plaza® Container (Specify Color)	193
FG396300	3964-L5	Hardware Kit for Plaza® Container	193
FG396300	3964-L6	Lock and Key (Optional)	193
FG396400	3964-L2	Molded Polyliner Holding Kit for Plaza® Container	193
FG396400	3964-L3	Latch Kit for Plaza® Container	193
FG396400	3964-L4	Refuse Door Replacement Kit for Plaza® Container (Specify Color)	193
FG396400	3964-L5	Hardware Kit for Plaza® Container	193
FG396400	3964-L6	Lock and Key (Optional)	193
FG396500	3964-L2	Molded Polyliner Holding Kit for Plaza® Container	193
FG396500	3964-L3	Latch Kit for Plaza® Container	193
FG396500	3964-L4	Refuse Door Replacement Kit for Plaza® Container (Specify Color)	193
FG396500	3964-L5	Hardware Kit for Plaza® Container	193
FG396500	3964-L6	Lock and Key (Optional)	193
FG396500	3965-L1	Ashtray Kit for Plaza® Container	193
FG396600	3961-L1	Ash/Trash Top for 20 U.S. gal (75.7 L) Landmark™ Series Container (Specify Color)	148
FG396600	3961-L2	Base for 20 U.S. gal (75.7 L) Landmark® Series Container (Specify Color)	188
FG396600	3961-L3	Sand Pan Insert w/ Wing Nut for 20 U.S. gal (75.7 L) Landmark® Series Container	188
FG396600	3962-L2	Stationary Collar for 20 U.S. gal (75.7 L) Landmark® Series Container (Specify Color)	188
FG396600	3970-L1	Deco Leg 35 U.S. gal (132.5 L)	188
FG396600	3970-L2	Steel Upright 35 U.S. gal (132.5 L)	188
FG396600	3970-L5	Deco Leg 35 U.S. gal (132.5 L)	188
FG396700	3961-L2	Base for 20 U.S. gal (75.7 L) Landmark® Series Container (Specify Color)	188
FG396700	3962-L1	Funnel Top/Stationary Collar for 20 U.S. gal (75.7 L) Landmark® Series Container	188
FG396700	3962-L3	Piano Hinge for 20 U.S. gal (75.7 L) Landmark® Series Container	188
FG396700	3970-L5	Deco Leg 35 U.S. gal (132.5 L)	188
FG396700	3975-L8	Restraint Strap w/ Hardware for Landmark® Series Container	188
FG396700	3975-L9	Hinge w/ Hardware for Landmark® Series Container	188
FG396800	3964-L6	Lock and Key (Optional)	148
FG396873	3968-L1	Plaza® "Bottle/Can" Recycling Insert (Specify Color)	148
FG396900	3964-L6	Lock and Key (Optional)	148
FG396973	3969-L1	Plaza® "Paper" Recycling Insert (Specify Color)	148
FG397000	3970-L1	Deco Leg 35 U.S. gal (132.5 L)	188
FG397000	3970-L2	Steel Upright 35 U.S. gal (132.5 L)	188

Fits	Part Number	Description	Page #
FG397000	3970-L5	Deco Leg 35 U.S. gal (132.5 L)	188
FG397000	3972-L2	Hardware Kit for Landmark® Series Container	188
FG397000	3975-L1	Dome Top for Landmark® Series Container (Specify Color)	188
FG397000	3975-L2	Base for 35 U.S. gal (132.5 L) and 50 U.S. gal (189.3 L) Landmark® Series Container (Specify Color)	188
FG397000	3975-L3	Stationary/Moving Collar for Landmark™ Series Container (Specify Color)	188
FG397000	3975-L5	Stationary Collar w/o Hinge (Specify Color)	188
FG397000	3975-L8	Restraint Strap w/ Hardware for Landmark™ Series Container	188
FG397000	3975-L9	Hinge w/ Hardware for Landmark® Series Container	188
FG397001	3970-88	Stationary Collar w/o Hinge (Specify Color)	188
FG397001	3970-L1	Deco Leg 35 U.S. gal (132.5 L)	188
FG397001	3970-L2	Steel Upright 35 U.S. gal (132.5 L)	188
FG397001	3970-L5	Deco Leg 35 U.S. gal (132.5 L)	188
FG397001	3972-L2	Hardware Kit for Landmark® Series Container	188
FG397001	3975-L2	Base for 35 U.S. gal (132.5 L) and 50 U.S. gal (189.3 L) Landmark® Series Container (Specify Color)	188
FG397001	3975-L8	Restraint Strap w/ Hardware for Landmark™ Series Container	188
FG397001	3975-L9	Hinge w/ Hardware for Landmark® Series Container	188
FG397001	3975-M2	Dome Top w/ Hole and Hardware for Landmark® Series Container (Specify Color)	188
FG397001	3975-M3	Ashtray for Landmark Dome Top Container	188
FG397088	3970-L1	Deco Leg 35 U.S. gal (132.5 L)	188
FG397088	3970-L2	Steel Upright 35 U.S. gal (132.5 L)	188
FG397088	3970-L4	Lock w/ Key	188
FG397088	3970-L5	Deco Leg 35 U.S. gal (132.5 L)	188
FG397088	3972-L2	Hardware Kit for Landmark® Series Container	188
FG397088	3975-L1	Dome Top for Landmark® Series Container (Specify Color)	188
FG397088	3975-L2	Base for 35 U.S. gal (132.5 L) and 50 U.S. gal (189.3 L) Landmark® Series Container (Specify Color)	188
FG397088	3975-L4	Stationary/Moving Collar	188
FG397088	3975-L8	Restraint Strap w/ Hardware for Landmark® Series Container	188
FG397088	3975-L9	Hinge w/ Hardware for Landmark™ Series Container	188
FG397100	3970-L1	Deco Leg 35 U.S. gal (132.5 L)	188
FG397100	3970-L2	Steel Upright 35 U.S. gal (132.5 L)	188
FG397100	3970-L5	Deco Leg 35 U.S. gal (132.5 L)	188
FG397100	3972-L2	Hardware Kit for Landmark® Series Container	188
FG397100	3975-L2	Base for 35 U.S. gal (132.5 L) & 50 U.S. gal	188
FG397100	3975-L5	Stationary Collar w/o Hinge for Landmark® Series Container (Specify Color)	188
FG397100	3976-L1	Ash/Trash Top for 35 U.S. gal (132.5 L) and 50 U.S. gal (189.3 L) Landmark® Series Container (Specify Color)	188
FG397100	3976-L2	Sand Pan Insert w/ Wing Nut for 35 U.S. gal	188
FG397200	3970-L5	Deco Leg 35 U.S. gal (132.5 L)	188
FG397200	3972-L1	Funnel Top/Stationary Collar for 35 U.S. gal (132.5 L) and 50 U.S. gal (189.3 L) Landmark® Series Container (Specify Color)	188
FG397200	3972-L2	Hardware Kit for Landmark® Series Containers	188
FG397200	3975-L2	Base for 35 U.S. gal (132.5 L) and 50 U.S. gal (189.3 L) Landmark® Series Container (Specify Color)	188
FG397200	3975-L8	Restraint Strap w/ Hardware for Landmark® Series Container	188
FG397200	3975-L9	Hinge w/ Hardware for Landmark® Series Container	188
FG397500	3972-L2	Hardware Kit for Landmark® Series Container	188, 195
FG397500	3975-L1	Dome Top for Landmark® Series Container (Specify Color)	188, 195
FG397500	3975-L2	Base for 35 U.S. gal (132.5 L) and 50 U.S. gal (189.3 L) Landmark® Series Container (Specify Color)	188, 195
FG397500	3975-L3	Stationary/Moving Collar for Landmark Container (Specify Color)	188, 195
FG397500	3975-L5	Stationary Collar w/o Hinge (Specify Color)	188, 195
FG397500	3975-L6	Deco Leg for 50 U.S. gal (189.3 L) Landmark® Series Container (Specify Color)	188, 195
FG397500	3975-L7	Steel Upright for 50 U.S. gal (189.3 L) Landmark® Series Container	188, 195
FG397500	3975-L8	Restraint Strap w/ Hardware for Landmark® Series Container	188, 195
FG397500	3975-L9	Hinge w/ Hardware for Landmark® Series Container	188, 195
FG397501	3972-L2	Hardware Kit for Landmark® Series Container	188, 195
FG397501	3975-89	Stationary Collar w/o Hinge (Specify Color)	188, 195
FG397501	3975-L2	Base for 35 U.S. gal (132.5 L) and 50 U.S. gal (189.3 L) Landmark® Series Container (Specify Color)	188, 195
FG397501	3975-L3	Stationary/Moving Collar for Landmark Container (Specify Color)	188, 195
FG397501	3975-L6	Deco Leg for 50 U.S. gal (189.3 L) Landmark® Series Container (Specify Color)	188, 195
FG397501	3975-L7	Steel Upright for 50 U.S. gal (189.3 L) Landmark® Series Container	188, 195
FG397501	3975-L8	Restraint Strap w/ Hardware for Landmark® Series Container	188, 195
FG397501	3975-L9	Hinge w/ Hardware for Landmark® Series Container	188, 195
FG397501	3975-M2	Dome Top w/ Hole and Hardware for Landmark Container (Specify Color)	188, 195
FG397501	3975-M3	Ashtray for Landmark Dome Top Container	188, 195

Fits	Part Number	Description	Page #
FG397589	3975-L4	Stationary/Moving Collar	195
FG397589	3975-M4	Polyliner Retainer Strap	195
FG402000	4020-L1	20 U.S. gal (75.7 L) Replacement Liner	179
FG402000	4020-L3	Replacement Feet (4)	179
FG402100	4020-L3	Replacement Feet (4)	179
FG402100	4021-L1	32 U.S. gal (121.1 L) Replacement Liner	179
FG402100	4021-L2	Funnel Top Kit	179
FG409100	3424-L6	4" dia (10.2 cm) Swivel Caster	227, 278
FG409100	4091-L1	Top Shelf (Specify Color)	227, 278
FG409100	4091-L2	Middle Shelf (Specify Color)	227, 278
FG409100	4091-L3	Bottom Shelf (Specify Color)	227, 278
FG409100	4091-L5	Upright	227, 278
FG409100	4091-L6	Handle Kit (Specify Color)	227, 278
FG409200	3424-L6	4" dia (10.2 cm) Swivel Caster	227
FG409200	4091-L1	Top Shelf (Specify Color)	227
FG409200	4091-L2	Middle Shelf (Specify Color)	227
FG409200	4091-L3	Bottom Shelf (Specify Color)	227
FG409200	4091-L5	Upright	227
FG409200	4091-L6	Handle Kit (Specify Color)	227
FG409200	4092-L1	Side Panel Kit, (4) Panels	227
FG409300	3424-L6	4" dia (10.2 cm) Swivel Caster	227, 278
FG409300	4091-L1	Top Shelf (Specify Color)	227, 278
FG409300	4091-L2	Middle Shelf (Specify Color)	227, 278
FG409300	4091-L3	Bottom Shelf (Specify Color)	227, 278
FG409300	4091-L5	Upright	227, 278
FG409300	4091-L6	Handle Kit (Specify Color)	227, 278
FG409300	4093-L1	Panel Kit (1 Back and 2 Side Panels) (Specify Color)	227, 278
FG409400	3424-L6	4" dia (10.2 cm) Swivel Caster	227
FG409400	4091-L1	Top Shelf (Specify Color)	227
FG409400	4091-L2	Middle Shelf (Specify Color)	227
FG409400	4091-L3	Bottom Shelf (Specify Color)	227
FG409400	4091-L5	Upright	227
FG409400	4091-L6	Handle Kit (Specify Color)	227
FG409400	4092-L1	Side Panel Kit, (4) Panels	227
FG409400	4093-L1	Panel Kit (1 Back and 2 Side Panels) (Specify Color)	227
FG409400	4094-L1	Door Kit w/ Lock (Specify Color)	227
FG409400	4094-L4	Drawer (Specify Color)	227
FG409500	3424-L6	4" dia (10.2 cm) Swivel Caster	227
FG409500	4091-L1	Top Shelf (Specify Color)	227
FG409500	4091-L2	Middle Shelf (Specify Color)	227
FG409500	4091-L3	Bottom Shelf (Specify Color)	227
FG409500	4091-L5	Upright	227
FG409500	4091-L6	Handle Kit (Specify Color)	227
FG409500	4093-L1	Panel Kit (1 Back and 2 Side Panels) (Specify Color)	227
FG409500	4094-L1	Door Kit w/ Lock (Specify Color)	227
FG409600	3424-L6	4" dia (10.2 cm) Swivel Caster	227
FG409600	4091-L1	Top Shelf (Specify Color)	227
FG409600	4091-L2	Middle Shelf (Specify Color)	227
FG409600	4091-L3	Bottom Shelf (Specify Color)	227
FG409600	4091-L5	Upright	227
FG409600	4091-L6	Handle Kit (Specify Color)	227
FG430000	4300-L3	Joint Kit	225, 276
FG430000	4300-L4	Joint Kit	225, 276
FG430000	4300-L5	Front/Rear Support Kit	225, 276
FG430000	4300-L6	Front/Rear Support Kit	225, 276
FG430000	4300-L7	Cord Cap	225, 276
FG430000	4300-L8	3 N 1 Caster Kit	225, 276
FG430000	4300-L9	Foot Pedal Kit	225, 276
FG430000	4501-L1	5" dia (12.7 cm) Fixed Caster	225, 276
FG430000	4501-L2	5" dia (12.7 cm) Swivel Caster	225, 276
FG430000	6180-L2	Swivel Caster w/ Brake	225, 276
FG440100	4501-L1	5" dia (12.7 cm) Fixed Caster	218, 279
FG440100	4501-L1	5" dia (12.7 cm) Rigid Caster	218, 279
FG440100	4501-L2	5" dia (12.7 cm) Swivel Caster	218, 279
FG440186	4401-L1	Wheel Kit	274
FG440300	4300-L2	Bolt Kit	210, 279
FG440300	4402-L1	5" dia (12.7 cm) Swivel Caster	210, 279
FG440300	4402-L2	5" dia (12.7 cm) Rigid Caster	210, 279
FG440300	7907-L1	24" (61 cm) Cross Bar Handle (Specify Color)	210, 279
FG440300	7912-L2	Adapter Block (Specify Color)	210, 279
FG440300	7931-L2	6" dia (15.2 cm) Swivel Caster	210, 279
FG440300	7931-L3	6" dia (15.2 cm) Rigid Caster	210, 279
FG440600	4300-L2	Bolt Kit (Specify Color)	210
FG440600	4406-L6	6" dia (15.2 cm) Swivel/Fixed Caster Kit	210
FG440600	7907-L1	24" (61 cm) Cross Bar Handle	210
FG440600	7912-L2	Adapter Block	210
FG440600	7931-L3	6" dia (15.2 cm) Rigid Caster	210
FG443600	4300-L1	Lag Screws (4)	210, 279
FG443600	4300-L2	Bolt Kit	210, 279
FG443600	4436-L8	8" dia Swivel/Fixed Caster Kit (TPR)	210, 279
FG443600	4472-L3	Hardware Kit	210, 279
FG443600	7907-L1	24" (61 cm) Cross Bar Handle (Specify Color)	210, 279
FG443600	7912-L2	Adapter Block (Specify Color)	210, 279
FG443600	7931-L3	6" dia (15.2 cm) Rigid Caster	210, 279
FG443610	4300-L2	Bolt Kit	210
FG443610	4402-L3	8" dia (20.3 cm) Pneumatic Swivel Caster	210
FG443610	4402-L4	8" dia (20.3 cm) Pneumatic Rigid Caster	210
FG443610	7901-L1	24" w x 48" l (61 cm x 121.9 cm) Deck w/ Adapters (Specify Color)	210

Fits	Part Number	Description	Page #
FG443610	7907-L1	24" (61 cm) Cross Bar Handle (Specify Color)	210
FG443610	7912-L2	Adapter Block (Specify Color)	210
FG444100	4300-L1	Lag Screws (4)	210
FG444100	4300-L2	Bolt Kit	210
FG444100	7907-L1	24" (61 cm) Cross Bar Handle (Specify Color)	210
FG444100	7912-L2	Adapter Block (Specify Color)	210
FG444100	7932-L2	8" dia (20.3 cm) Swivel Caster	210
FG444100	7932-L3	8" dia (20.3 cm) Rigid Caster	210
FG446600	4300-L2	Bolt Kit	210
FG446600	4471-L1	60" l x 30" w – One Handle Corner Caster Placement	210
FG446600	4471-L3	30" (76.2 cm) Cross Bar Handle	210
FG446600	7912-L2	Adapter Block (Specify Color)	210
FG446600	7931-L2	6" dia (15.2 cm) Swivel Caster	210
FG446600	7931-L3	6" dia (15.2 cm) Rigid Caster	210
FG446610	4300-L2	Bolt Kit	210
FG446610	4402-L3	8" dia (20.3 cm) Pneumatic Swivel Caster	210
FG446610	4402-L4	8" dia (20.3 cm) Pneumatic Rigid Caster	210
FG446610	4471-L3	30" (76.2 cm) Cross Bar Handle	210
FG446610	7912-L2	Adapter Block (Specify Color)	210
FG447100	4300-L2	Bolt Kit	210
FG447100	4471-L1	60" l x 30" w – One Handle Corner Caster Placement	210
FG447100	4471-L3	30" (76.2 cm) Cross Bar Handle	210
FG447100	7912-L2	Adapter Block (Specify Color)	210
FG447100	7932-L2	8" dia (20.3 cm) Swivel Caster	210
FG447100	7932-L3	8" dia (20.3 cm) Rigid Caster	210
FG450088	4500-M1	Universal Leg (Specify Color)	223, 278
FG450088	4500-M2	Hardware Kit	223, 278
FG450088	4501-L1	5" dia (12.7 cm) Rigid Caster	223, 278
FG450088	4501-L2	5" dia (12.7 cm) Swivel Caster	223, 278
FG450500	4500-M1	Universal Leg (Specify Color)	223, 278
FG450500	4505-L1	Top Shelf (Specify Color)	223, 278
FG450500	4505-L2	Bottom Shelf (Specify Color)	223, 278
FG451288	4510-L5	Small Back Panel	219
FG451288	4512-L3	Small Left Door	219
FG451288	4512-L4	Small Right Door	219
FG451288	4512-L5	Top and Bottom Hinge Kit	219
FG451288	4512-L6	Door Lock and Hardware Kit	219
FG451288	4512-L7	Back Panel Bracket	219
FG451288	4513-L1	Handle	219
FG451288	4532-L1	5" dia (12.7 cm) Rigid Caster	219
FG451288	4532-L2	5" dia (12.7 cm) Swivel Caster w/ Lock	219
FG451288	4532-L7	Caster Kit	219
FG451288	9128-L3	10' Electrical Power Strip	219
FG451388	4513	14" Drawer Slide (Full Ext.)	219
FG451388	4510-L5	Small Back Panel	219
FG451388	4511-L1	Large Drawer Front w/o Lock Hole	219
FG451388	4511-L4	Large Steel Drawer	219
FG451388	4512-L7	Back Panel Bracket	219
FG451388	4513-L1	Handle	219
FG451388	4513-L2	Four Drawer Hardware Kit	219
FG451388	4532-L1	5" dia (12.7 cm) Rigid Caster	219
FG451388	4532-L2	5" dia (12.7 cm) Swivel Caster w/ Lock	219
FG451388	9128-L3	10' Electrical Power Strip	219
FG452010	4500-M1	Universal Leg (Specify Color)	223
FG452088	4500-M1	Universal Leg (Specify Color)	223, 278
FG452088	4500-M2	Hardware Kit	223, 278
FG452088	4501-L1	5" dia (12.7 cm) Fixed Caster	223, 278
FG452088	4501-L1	5" dia (12.7 cm) Rigid Caster	223, 278
FG452088	4501-L2	5" dia (12.7 cm) Swivel Caster	223, 278
FG452500	4500-M1	Universal Leg (Specify Color)	223, 278
FG452500	4501-L1	5" dia (12.7 cm) Rigid Caster	223, 278
FG452500	4501-L2	5" dia (12.7 cm) Swivel Caster	223, 278
FG453288	4512-L5	Top and Bottom Hinge Kit	219
FG453288	4512-L6	Door Lock and Hardware Kit	219
FG453288	4512-L7	Back Panel Bracket	219
FG453288	4530-L1	Bottom Shelf w/ Slots	219
FG453288	4530-L2	Medium Back Panel	219
FG453288	4532-L1	5" dia (12.7 cm) Rigid Caster	219
FG453288	4532-L2	5" dia (12.7 cm) Swivel Caster w/ Lock	219
FG453288	4532-L3	Handle	219
FG453288	4532-L4	Left Door	219
FG453288	4532-L5	Right Door	219
FG453288	4532-L6	Adjustable Shelf	219
FG453288	4532-L7	Caster Kit	219
FG453288	9128-L3	10' Electrical Power Strip	219
FG453388	4512-L5	Top and Bottom Hinge Kit	219
FG453388	4512-L6	Door Lock and Hardware Kit	219
FG453388	4512-L7	Back Panel Bracket	219
FG453388	4513-L2	Four Drawer Hardware Kit	219
FG453388	4530-L1	Bottom Shelf w/ Slots	219
FG453388	4530-L2	Medium Back Panel	219
FG453388	4532-L1	5" dia (12.7 cm) Rigid Caster	219
FG453388	4532-L2	5" dia (12.7 cm) Swivel Caster w/ Lock	219
FG453388	4532-L3	Handle	219
FG453388	4532-L5	Right Door	219
FG453388	4532-L6	Adjustable Shelf	219
FG453388	4532-L7	Caster Kit	219
FG453388	4533-L1	Small Drawer Front	219

Fits	Part Number	Description	Page #
FG453388	4533-L2	22" Drawer Slide	219
FG453388	4533-L3	Metal Drawer	219
FG453388	9T28-L3	10" Electrical Power Strip	219
FG453588	4513	14" Drawer Slide	219
FG453588	4510-L1	Universal Leg (Specify Color)	219
FG453588	4511-L2	Large Drawer Front w/ Lock Hole	219
FG453588	4511-L4	Large Steel Drawer	219
FG453588	4532-L1	5" dia (12.7 cm) Caster	219
FG453588	4532-L2	5" dia (12.7 cm) Swivel Caster w/ Lock	219
FG453588	4532-L3	Handle	219
FG453588	4532-L7	Caster Kit	219
FG453588	4535-L1	Hardware Kit	219
FG453588	4535-L2	Hardware Kit for Brackets	219
FG453588	9T28-L3	10" Electrical Power Strip	219
FG454500	4500-M1	Universal Leg (Specify Color)	223
FG454600	4500-L1	Universal Leg (Specify Color)	223
FG454600	4500-M2	Hardware Kit	223
FG454600	4532-L1	5" dia (12.7 cm) Rigid Caster	223
FG454600	4546-10		223
FG454600	4546-L1	5" dia (12.7 cm) Swivel Caster	223
FG454610	4500-L1	Universal Leg (Specify Color)	223
FG454888	4513	14" Drawer Slide (Full Ext.)	219
FG454888	4511-L1	Large Drawer Front w/o Lock Hole	219
FG454888	4511-L4	Large Steel Drawer	219
FG454888	4512-L5	Top and Bottom Hinge Kit	219
FG454888	4512-L6	Door Lock and Hardware Kit	219
FG454888	4512-L7	Back Panel Bracket	219
FG454888	4513-L2	Four Drawer Hardware Kit	219
FG454888	4532-L1	5" dia (12.7 cm) Rigid Caster	219
FG454888	4532-L2	5" dia (12.7 cm) Swivel Caster w/ Lock	219
FG454888	4532-L3	Handle	219
FG454888	4532-L5	Right Door	219
FG454888	4532-L6	Adjustable Shelf	219
FG454888	4532-L7	Caster Kit	219
FG454888	4548-L1	Bottom Shelf w/ Slots	219
FG454888	4548-L2	Large Back Panel	219
FG454888	9T28-L3	10" Electrical Power Strip	219
FG460800	4608-L1	8 cu ft (.2 m ³) Body w/ Bolts (Specify Color)	235
FG460800	4608-L2	8 cu ft (.2 m ³) Base	235
FG460800	4608-L3	4" dia (10.2 cm) Swivel Caster	235
FG460800	4608-L4	4" dia (10.2 cm) Rigid Caster	235
FG461100	4611-L1	14 cu ft (.4 m ³) Spring Platform and Kit	235
FG461100	4614-L2	14 cu ft (.4 m ³) Base	235
FG461100	4614-L3	5" dia (12.7 cm) Swivel Caster	235
FG461100	4614-L4	5" dia (12.7 cm) Rigid Caster	235
FG461200	4608-L3	4" dia (10.2 cm) Swivel Caster	235
FG461200	4608-L4	4" dia (10.2 cm) Rigid Caster	235
FG461200	4612-L1	12 cu ft (.3 m ³) Body w/ Bolts (Specify Color)	235
FG461200	4612-L2	12 cu ft (.3 m ³) Base	235
FG461400	4614-L1	14 cu ft (.4 m ³) Body w/ Bolts (Specify Color)	235
FG461400	4614-L2	14 cu ft (.4 m ³) Base	235
FG461400	4614-L3	5" dia (12.7 cm) Swivel Caster	235
FG461400	4614-L4	5" dia (12.7 cm) Rigid Caster	235
FG461600	4614-L3	5" dia (12.7 cm) Swivel Caster	235
FG461600	4614-L4	5" dia (12.7 cm) Rigid Caster	235
FG461600	4616-L1	16 cu ft (.5 m ³) Body w/ Bolts (Specify Color)	235
FG461600	4616-L2	16 cu ft (.5 m ³) Base	235
FG461673	4616-L2	16 cu Truck Base	235
FG461800	4614-L3	5" dia (12.7 cm) Swivel Caster	235
FG461800	4614-L4	5" dia (12.7 cm) Rigid Caster	235
FG461800	4618-L1	20 cu ft (.6 m ³) Spring Platform and Kit	235
FG461800	4619-L2	20 cu ft (.6 m ³) Base	235
FG461900	4614-L3	5" dia (12.7 cm) Swivel Caster	235
FG461900	4614-L4	5" dia (12.7 cm) Rigid Caster	235
FG461900	4619-L1	20 cu ft (.6 m ³) Body w/ Bolts (Specify Color)	235
FG461900	4619-L2	20 cu ft (.6 m ³) Base	235
FG470800	4708-L2	8 cu ft (.2 m ³) Base	235
FG470800	4708-L3	4" dia (10.2 cm) Swivel Caster	235
FG470800	4708-L4	4" dia (10.2 cm) Rigid Caster	235
FG471200	4708-L4	4" dia (10.2 cm) Rigid Caster	235
FG471200	4712-L2	12 cu ft (.3 m ³) Base	235
FG471600	4614-L3	5" dia (12.7 cm) Swivel Caster	235
FG471600	4614-L4	5" dia (12.7 cm) Rigid Caster	235
FG471600	4716-L2	16 cu ft (.5 m ³) Base	235
FG472000	4614-L3	5" dia (12.7 cm) Swivel Caster	235
FG472000	4614-L4	5" dia (12.7 cm) Rigid Caster	235
FG472000	4720-L2	20 cu ft (.6 m ³) Base	235
FG472700	4727-L1	5" dia (12.7 cm) Swivel Caster	235
FG472741	1316-L4	Hitch Kit (Specify Color)	235
FG472741	4727-L2	6" dia (15.2 cm) Rigid Caster	235
FG472741	4727-L3	6" dia (15.2 cm) Swivel Caster	235
FG614200	2613-L1	Liner w/ Bail for Step-On Can	141
FG614200	2613-L2	Bail ONLY for Step-On Can	141
FG614200	6142-L2	Pedal/Lifter Kit	141
FG614300	6143-L1	Lifter	141
FG614300	6143-L2	Lid (Specify Color)	141
FG614300	6143-L3	Pedal	141
FG614300	6143-L4	Hinge Pin Kit	141
FG614400	6143-L2	Lid (Specify Color)	141

Fits	Part Number	Description	Page #
FG614400	6143-L3	Pedal	141
FG614400	6143-L4	Hinge Pin Kit	141
FG614400	6144-L1	Lifter	141
FG614500	6145-L1	Lifter	141
FG614500	6145-L2	Lid (Specify Color)	141
FG614500	6145-L3	Pedal	141
FG614500	6145-L4	Hinge Pins	141
FG614600	6145-L2	Lid (Specify Color)	141
FG614600	6145-L3	Pedal	141
FG614600	6145-L4	Hinge Pins	141
FG614600	6146-L1	Lifter	141
FG614687	6146-L2	Quiet Damper and Pin	142
FG614687	6146-L3	Lifter Pin and Damper	142
FG614687	6146-L4	Step-On Pedal	142
FG614700	6146-L2	Quiet Damper and Pin	142
FG614700	6146-L4	Step-On Pedal	142
FG614700	6147-L1	Metal Bag Retaining Straps	142
FG614700	6147-L2	Damper and Pin	142
FG614787	6146-L2	Quiet Damper and Pin	142
FG614787	6146-L4	Step-On Pedal	142
FG614787	6147-L2	Damper and Pin	142
FG617388	6173-L1	4" dia Caster	99
FG617388	6173-L9	Wheel and Axle Parts	99
FG617388	6173-M0	Back Upright for Cleaning Cart (Specify Color)	99
FG617388	6173-M4	Bottom Shelf for Cleaning Cart (Specify Color)	99
FG617388	6173-M5	Handle for Cleaning Cart Trolley (Specify Color)	99
FG617388	6173-M6	Left Side Upright for Cleaning Cart (Specify Color)	99
FG617388	6173-M7	Right Side Upright for Cleaning Cart (Specify Color)	99
FG617388	6173-M8	Top Shelf for Cleaning Cart (Specify Color)	99
FG617388	6173-M9	Middle Shelf for Cleaning Cart (Specify Color)	99
FG617700	6177-L1	Lifter	147
FG617700	6177-L2	Pedal	147
FG617700	6177-L3	Spring	147
FG618000	4501-L1	5" dia (12.7 cm) Rigid Caster	220
FG618000	4501-L1	5" dia (12.7 cm) Rigid Caster	220
FG618000	4501-L2	5" dia (12.7 cm) Swivel Caster	220
FG618000	4505-L1	Top Shelf (Specify Color)	220
FG618000	4505-L2	Bottom Shelf (Specify Color)	220
FG618000	4505-L4	Left Upright (Specify Color)	220
FG618000	4505-L5	Universal Leg (Specify Color)	220
FG618000	6180-L2	Swivel Caster w/ Brake	220
FG618000	6180-L8	Compartment Box	220
FG618000	6180-L9	Storage Bin (Specify Color)	220
FG618088	4501-L1	5" dia (12.7 cm) Rigid Caster	220
FG618088	4501-L1	5" dia (12.7 cm) Rigid Caster	220
FG618088	4501-L2	5" dia (12.7 cm) Swivel Caster	220
FG618088	4505-L1	Top Shelf (Specify Color)	220
FG618088	4505-L2	Bottom Shelf (Specify Color)	220
FG618088	4505-L5	Universal Leg (Specify Color)	220
FG618088	6180-L2	Swivel Caster w/ Brake	220
FG618088	6180-L7	Cabinet, Panel, and Hardware Kit	220
FG618088	6180-L8	Compartment Box	220
FG618088	6180-L9	Storage Bin (Specify Color)	220
FG618100	6181-L2	Lock and Key	99
FG618400	6173-L9	Wheel and Axle Parts	242, 245
FG618688	6185-M1	Drain Kit	61
FG618688	6185-M2	Bucket	61
FG618688	6185-M3	Bail	61
FG618688	7570-L2	3" dia (7.6 cm) Caster	61
FG618900	6193	Vinyl Replacement Bag with Zippered Side Opening	106
FG618900	6173-M1	Polyliner Holder	106
FG618900	6189-L1	Hardware Kit	106
FG618900	6189-L2	Back Panel Kit (Specify Color)	106
FG618900	6189-L3	Vacuum Cleaner Holder Kit	106
FG618900	6189-L4	8" dia (20.3 cm) Rigid Caster	106
FG618900	6189-L5	8" dia (20.3 cm) Swivel Caster w/ Brake	106
FG618900	6189-L6	Vinyl Bag (Plat. Color Only)	106
FG618900	6190-L1	Bumper Kit	106
FG618900	9194-M1	8" (20.3 cm) Ballbearing Wheel Kit	106
FG618900	9194-M2	Vacuum Restraint Kit	106
FG619000	6193	Vinyl Replacement Bag with Zippered Side Opening	106
FG619000	6173-M1	Polyliner Holder	106
FG619000	6189-L1	Hardware Kit	106
FG619000	6189-L2	Back Panel Kit (Specify Color)	106
FG619000	6189-L3	Vacuum Cleaner Holder Kit	106
FG619000	6189-L4	8" dia (20.3 cm) Rigid Caster	106
FG619000	6189-L5	8" dia (20.3 cm) Swivel Caster w/ Brake	106
FG619000	6189-L6	Vinyl Bag	106
FG619000	6190-L1	Bumper Kit	106
FG619000	7575-88	7575-L8 Gear Pack/P Plates (set of 2)	106
FG619000	9194-M1	8" (20.3 cm) Ballbearing Wheel Kit	106
FG619000	9194-M2	Vacuum Restraint Kit	106
FG619100	6193	Vinyl Replacement Bag with Zippered Side Opening	106
FG619100	6173-M1	Polyliner Holder	106
FG619100	6189-L1	Hardware Kit	106
FG619100	6189-L2	Back Panel Kit (Specify Color)	106
FG619100	6189-L3	Vacuum Cleaner Holder Kit	106
FG619100	6189-L4	8" dia (20.3 cm) Rigid Caster	106

* 7 Week Lead Time

Fits	Part Number	Description	Page #
FG619100	6189-L5	8" dia (20.3 cm) Swivel Caster	106
FG619100	6189-L6	Vinyl Bag	106
FG619100	6190-L1	Bumper Kit	106
FG619100	6191-L1	Lock w/ (2) Keys	106
FG619100	9T94-M1	8" (20.3 cm) Ballbearing Wheel Kit	106
FG619100	9T94-M2	Vacuum Restraint Kit	106
FG619200	6193	Vinyl Replacement Bag with Zippered Side Opening	106
FG619200	6173-M1	Polyliner Holder	106
FG619200	6189-L1	Hardware Kit	106
FG619200	6189-L2	Back Panel Kit (Specify Color)	106
FG619200	6189-L3	Vacuum Cleaner Holder Kit	106
FG619200	6189-L4	8" dia (20.3 cm) Rigid Caster	106
FG619200	6189-L5	8" dia (20.3 cm) Swivel Caster	106
FG619200	6189-L6	Vinyl Bag	106
FG619200	6190-L1	Bumper Kit	106
FG619200	6191-L1	Lock w/ (2) Keys	106
FG619200	9T94-M1	8" (20.3 cm) Ballbearing Wheel Kit	106
FG619200	9T94-M2	Vacuum Restraint Kit	106
FG619700	6191-L1	Lock w/ (2) Keys	107
FG628600	6287-L3	Barrier Tape Adapter Plate	245
FG628700	6287-L1	Replacement Belt Cassette	244, 245
FG628700	6287-L2	Weight Ring for Barricade	244, 245
FG628700	6287-L3	Barrier Tape Adapter Plate	244, 245
FG630000	6146-L2	Quiet Damper and Pin	142
FG630000	6300-L1	Step On Pedal	142
FG738000	7380-L1	Caster 3" dia (7.6)	63
FG738000	7380-L2	12" Handle	63
FG738000	7380-L3	Spring	63
FG757088	7570-L2	3" dia (7.6 cm) Caster	63
FG757588	7575-L8	Gear Pack/P Plates (Set of 2)	63
FG757588	7575-M2	Spring	63
FG757688	6185-M1	Drain Kit	61
FG757688	6185-M2	Bucket	61
FG757688	6185-M3	Bail	61
FG757688	7570-L2	3" dia (7.6 cm) Caster	61
FG757688	7575-L5	Handle	61
FG757688	7575-L8	Gear Pack/P Plates (Set of 2)	61
FG757688	7575-M2	Spring	61
FG757788	7570-L2	3" dia (7.6 cm) Caster	60
FG757788	7575-L5	Handle	60
FG757788	7575-L7	Pan Head Screws (4)	60
FG757788	7575-L8	Gear Pack/P Plates (Set of 2)	60
FG757788	7575-M2	Spring	60
FG757888	7570-L2	3" dia (7.6 cm) Caster	60
FG757888	7575-L5	Handle	60
FG757888	7575-L7	Pan Head Screws (4)	60
FG757888	7575-L8	Gear Pack/P Plates (Set of 2)	60
FG757888	7575-M2	Spring	60
FG758088	7570-L2	3" dia (7.6 cm) Caster	60
FG758888	7570-L2	3" dia (7.6 cm) Caster	60
FG759088	7570-L2	3" dia (7.6 cm) Caster	60
FG759088	7590-L1	Wringer Clip	60
FG767700	7575-L8	Gear and Rack (Set of 2)	61
FG767700	7575-M2	Spring	61
FG767700	9C75-L4	Screws for Bucket to Dolly	61
FG768000	6127-L1	Handle Grip	61
FG768000	9C75-L4	Screws for Bucket to Dolly	61
FG772000	7802-L1	Metal Latch for Toolbox	236
FG777700	7575-L8	Gear Pack/P Plates (Set of 2)	62
FG777700	7575-M2	Spring	62
FG777700	7580-L2	Quiet Caster for WaveBrake® Trolley	62
FG777700	9C75-L1	Trolley Hardware Kit	62
FG777700	9C75-L3	Trolley Handle with Maid Caddy	62
FG777700	9C75-L4	Screws for Bucket to Dolly	62
FG778000	7580-L2	Quiet Caster – WaveBrake® Trolley	62
FG778000	9C75-L1	Trolley Hardware Kit	62
FG778000	9C75-L3	Trolley Handle with Maid Caddy	62
FG780200	7802-L1	Metal Latch for Toolbox	236
FG780400	7802-L1	Metal Latch for Toolbox	236
FG780508	7806-L8	3-Point Strap	282
FG780588	7805-L2	Caster Kit	268
FG780588	7806-L1	Spanner Bar Kit (Specify Color)	268
FG780608	7806-L8	3-Point Strap	282
FG780688	7806-L1	Spanner Bar Kit (Specify Color)	268
FG781408	7806-L8	3-Point Strap	282
FG781488	7806-L1	Spanner Bar Kit (Specify Color)	282
FG781888	7818-L1	Restroom Door Label	39, 283
FG781888	7818-L4	Strap Kit	39, 283
FG781888	7818-L5	Screw/Liner Cover	39, 283
FG781888	7818-L6	Hardware Kit	39, 283
FG781988	7818-L1	Door Label	39, 283
FG781988	7818-L5	Screw/Liner Cover	39, 283
FG781988	7818-L6	Hardware Kit	39, 283
FG781988	7819-L1	Belt Kit	39, 283
FG781988	7819-L4	Strap	39, 283
FG782200	7822-L1	Top/Door/Pivot (Specify Color)	140
FG816088	6160-L1	Polyliner Holder w/ Bolts	165
FG816088	6160-L2	Hinge Straps	165
FG816088	8160-L1	15 U.S. gal (56.8 L) Base (Specify Color)	165

Fits	Part Number	Description	Page #
FG816088	8160-L2	15 U.S. gal (56.8 L) Top (Specify Color)	165
FG817088	6160-L2	Hinge Straps	165
FG817088	6170-L1	Polyliner Holder w/ Bolts	165
FG817088	8170-L1	25 U.S. gal (94.6 L) Base (Specify Color)	165
FG817088	8170-L2	25 U.S. gal (94.6 L) Top (Specify Color)	165
FG818088	6170-L1	Polyliner Holder w/ Bolts	202
FG818088	8180-L1	Ash Tray	202
FG818088	8180-L4	Door and Pivot (Specify Color)	202
FG818088	8180-L5	25 U.S. gal (94.6 L) w/o Doors (Specify Color)	202
FG818288	6170-L1	Polyliner Holder w/ Bolts	202
FG818288	8180-L1	Ash Tray	202
FG818488	6160-L1	Polyliner Holder w/ Bolts	202
FG818488	8184-L1	Ash Tray	202
FG818488	8184-L4	Door and Pivot (Specify Color)	202
FG818488	8184-L5	15 U.S. gal (56.8 L) Top w/o Doors (Specify Color)	202
FG818588	6160-L1	Polyliner Holder w/ Bolts	202
FG818588	8184-L1	Ash Tray	202
FG905800	9054-L2	UBO Strap (Specify Color)	159
FG905886	9054-L2	UBO Strap (Specify Color)	159
FG917188	9171-L4	45/65 Gal Ranger Ring (Specify Color)	192
FG917388	9171-L4	45/65 Gal Ranger Ring (Specify Color)	192
FG917500	9171-L4	45/65 Gal Ranger Ring (Specify Color)	192
FG917600	9171-L4	45/65 Gal Ranger Ring (Specify Color)	192
FG940600	9406-L2	Handle and Latch Kit	274
FG940700	9406-L2	Handle and Latch Kit	274
FG940800	9408-L1	Caster Kit	274
FG940800	9408-L5	CaterMax™ 100 Hinge Kit	274
FG940800	9408-L6	Handle/Latch/Stacking Lug Kit	274
FG9C7300	7580-L2	Quiet Caster for WaveBrake® Trolley	63
FG9F1900	9F19-L1	Dolly Strap	273
FG9M0000	9M00-L1	Wet/Dry Replacement Pan	94
FG9M0000	9M00-L2	Wet/Dry Replacement Yoke	94
FG9M0000	9M00-L3	Wet/Dry Replacement Blade	94
FG9P9000	3964-L6	Lock and Key (Optional)	193
FG9P9000	9P90-L1	Polyliner Retainer Kit	193
FG9P9100	3965-L1	Ashtray Kit for Plaza® Containers	193
FG9P9100	9P90-L1	Polyliner Retainer Kit	193
FG9S1100	9S11-L1	Bungee Strap (4-Pack)	243
FG9S1100	9S11-L2	Middle Panel (2-pack)	243
FG9T0600	9T06-L1	16" Pneumatic Wheel	214
FG9T0600	9T11-L2	40" x 70" Platform Deck (Specify Color)	214
FG9T0700	9T07-L1	12" Pneumatic Wheel	214
FG9T0700	9T11-L2	40" x 70" Platform Deck (Specify Color)	214
FG9T1100	7931-L2	6" dia (15.2 cm) Swivel Caster	210
FG9T1100	7931-L3	6" dia (15.2 cm) Rigid Caster	210
FG9T1100	9T11-L1	Crossbar Handle (Specify Color)	210
FG9T1100	9T11-L2	40" x 70" Platform Deck (Specify Color)	210
FG9T1200	4402-L3	8" dia (20.3 cm) Pneumatic Swivel Caster	210
FG9T1200	4402-L4	8" dia (20.3 cm) Pneumatic Rigid Caster	210
FG9T1200	9T11-L1	Crossbar Handle (Specify Color)	210
FG9T1200	9T11-L2	40" x 70" Platform Deck (Specify Color)	210
FG9T1300	1011-L2	4" dia (10.2 cm) Nonmarking Plate Caster	231
FG9T1300	9T13-L3	10" Wheel	231
FG9T1300	9T14-L2	Tilt Truck Handle Bracket	231
FG9T1400	1013-L2	4" dia (10.2 cm) Caster	231
FG9T1400	9T14-L1	10" Wheel	231
FG9T1400	9T14-L2	Tilt Truck Handle Bracket	231
FG9T1500	1315-L3	12" dia (30.5 cm) Wheel	231
FG9T1500	9T14-L2	Tilt Truck Handle Bracket	231
FG9T1500	9T15-L1	5" dia (12.7 cm) Swivel Caster	231
FG9T1600	1316-L3	12" dia (30.5 cm) Wheel	231
FG9T1600	9T14-L2	Tilt Truck Handle Bracket	231
FG9T1600	9T15-L1	5" dia (12.7 cm) Swivel Caster	231
FG9T1700	9T13-L3	10" Wheel	232
FG9T1700	9T17-L1	4" dia (10.2 cm) Swivel Caster	232
FG9T1800	1305-L3	10" dia (25.4 cm) Wheel	232
FG9T1800	1305-L4	Handle for 1/2 cu yd and 1 cu yd Tilt Trucks (Specify Color)	232
FG9T1800	9T18-L1	4" dia (10.2 cm) Swivel Caster	232
FG9T1900	6193	Vinyl Replacement Bag with Zippered Side Opening	106
FG9T1900	6173-M1	Polyliner Holder	106
FG9T1900	6189-L2	Back Panel Kit (Specify Color)	106
FG9T1900	6191-L1	Lock w/ (2) Keys	106
FG9T1900	9T94-M2	Vacuum Restraint Kit	106
FG9T2100	7932-L2	8" dia (20.3 cm) Swivel Caster	210
FG9T2100	7932-L3	8" dia (20.3 cm) Rigid Caster	210
FG9T2100	9T11-L1	Crossbar Handle (Specify Color)	210
FG9T2100	9T12-L1	40" x 70" Platform Deck (Specify Color)	210
FG9T2800	9T28-L1	33" x 18" Media Master™ Top	228
FG9T2800	9T28-L2	3" dia (7.6 cm) Caster Kit (4 swivel casters, 2 w/ locks, w/ 4 inserts)	228
FG9T2800	9T28-L3	10' Electrical Power Strip	228
FG9T2800	9T28-L4	Safety Strap	228
FG9T2900	3421-L5	End Panel	228
FG9T2900	9T28-L1	33" x 18" Media Master™ Top	228
FG9T2900	9T28-L2	3" dia (7.6 cm) Caster Kit (4 swivel casters, 2 w/ locks, w/ 4 inserts)	228
FG9T2900	9T28-L3	10' Electrical Power Strip	228

Fits	Part Number	Description	Page #
FG9T2900	9T28-L4	Safety Strap	228
FG9T3000	9T28-L1	33" x 18" Media Master™ Top	228
FG9T3000	9T28-L3	10" Electrical Power Strip	228
FG9T3000	9T28-L4	Safety Strap	228
FG9T3000	9T30-L1	4" dia (10.2 cm) Caster Kit	228
FG9T3000	9T30-L2	15.5" Extrusion	228
FG9T3200	3421-L5	End Panel	228
FG9T3200	9T28-L1	33" x 18" Media Master™ Top	228
FG9T3200	9T28-L3	10" Electrical Power Strip	228
FG9T3200	9T28-L4	Safety Strap	228
FG9T3200	9T30-L1	4" dia (10.2 cm) Caster Kit	228
FG9T3200	9T32-L1	20" Extrusion	228
FG9T3300	9T28-L3	10" Electrical Power Strip	228
FG9T3300	9T28-L4	Safety Strap	228
FG9T3300	9T30-L1	4" dia (10.2 cm) Caster Kit	228
FG9T3300	9T33-L1	40" x 20" Media Master™ Top	228
FG9T3300	9T33-L2	18" Extrusion	228
FG9T3400	4093-L1	Panel Kit (1 Back and 2 Side Panels) (Specify Color)	228
FG9T3400	4094-L1	Door Kit w/ Lock (Specify Color)	228
FG9T3400	9T28-L3	10" Electrical Power Strip	228
FG9T3400	9T28-L4	Safety Strap	228
FG9T3400	9T30-L1	4" dia (10.2 cm) Caster Kit	228
FG9T3400	9T33-L1	40" x 20" Media Master™ Top	228
FG9T3400	9T34-L1	25" Extrusion	228
FG9T3500	4091-L7	Extrusion	228
FG9T3500	4093-L1	Panel Kit (1 Back and 2 Side Panels) (Specify Color)	228
FG9T3500	4094-L1	Door Kit w/ Lock (Specify Color)	228
FG9T3500	9T28-L3	10" Electrical Power Strip	228
FG9T3500	9T28-L4	Safety Strap	228
FG9T3500	9T30-L1	4" dia (10.2 cm) Caster Kit	228
FG9T3500	9T33-L1	40" x 20" Media Master™ Top	228
FG9T3600	4091-L5	Upright	228
FG9T3600	4091-L7	Extrusion	228
FG9T3600	9T36-L1	Top Shelf	228
FG9T3600	9T36-L2	Middle Shelf	228
FG9T3600	9T36-L3	Bottom Shelf	228
FG9T3600	9T36-L4	Shelving Feet Kit	228
FG9T3700	4091-L5	Upright	228
FG9T3700	4091-L7	Extrusion	228
FG9T3700	9T36-L1	Top Shelf	228
FG9T3700	9T36-L2	Middle Shelf	228
FG9T3700	9T36-L3	Bottom Shelf	228
FG9T3700	9T36-L4	Shelving Feet Kit	228
FG9T3800	9T36-L1	Top Shelf	228
FG9T3800	9T36-L2	Middle Shelf	228
FG9T3800	9T36-L3	Bottom Shelf	228
FG9T3800	9T36-L4	Shelving Feet Kit	228
FG9T3800	9T38-L1	19.5" Extrusion	228
FG9T3900	9T36-L1	Top Shelf	228
FG9T3900	9T36-L2	Middle Shelf	228
FG9T3900	9T36-L3	Bottom Shelf	228
FG9T3900	9T36-L4	Shelving Feet Kit	228
FG9T3900	9T39-L1	14" Extrusion	228
FG9T4000	4091-L5	Upright	228
FG9T4000	4091-L7	Extrusion	228
FG9T4000	9T36-L1	Top Shelf	228
FG9T4000	9T36-L2	Middle Shelf	228
FG9T4000	9T36-L3	Bottom Shelf	228
FG9T4000	9T36-L4	Shelving Feet Kit	228
FG9T4100	4093-L1	Panel Kit (1 Back and 2 Side Panels) (Specify Color)	228
FG9T4100	4094-L1	Door Kit w/ Lock (Specify Color)	228
FG9T4200	4091-L5	Upright	228
FG9T4200	9T36-L1	Top Shelf	228
FG9T4200	9T36-L2	Middle Shelf	228
FG9T4200	9T36-L3	Bottom Shelf	228
FG9T4200	9T36-L5	5" dia (12.7 cm) Caster Kit (4 swivel casters, 2 w/ locks)	228
FG9T4300	9T36-L1	Top Shelf	228
FG9T4300	9T36-L2	Middle Shelf	228
FG9T4300	9T36-L3	Bottom Shelf	228
FG9T4300	9T36-L5	5" dia (12.7 cm) Caster Kit (4 swivel casters, 2 w/ locks)	228
FG9T4300	9T43-L1	18.75" Upright Kit	228
FG9T4500	9T50-L1	Upright	218
FG9T4500	9T50-L2	Upright with Handle	218
FG9T4500	9T50-L3	Work Surface	218
FG9T4500	9T50-L4	6" dia (15.2 cm) Rigid Caster	218
FG9T4500	9T50-L5	5" dia (12.7 cm) Swivel Caster	218
FG9T5000	9T50-L1	Upright	218
FG9T5000	9T50-L2	Upright with Handle	218
FG9T5000	9T50-L3	Work Surface	218
FG9T5000	9T50-L4	6" dia (15.2 cm) Rigid Caster	218
FG9T5000	9T50-L5	5" dia (12.7 cm) Swivel Caster	218
FG9T5200	9T50-L1	Upright	218
FG9T5200	9T50-L2	Upright with Handle	218
FG9T5200	9T50-L3	Work Surface	218
FG9T5200	9T50-L4	6" Rigid Caster	218
FG9T5200	9T50-L5	5" Swivel Caster	218
FG9T5400	9T54-L1	Caster Kit	218

Fits	Part Number	Description	Page #
FG9T5500	9T54-L1	Caster Kit	218
FG9T5500	9T55-L1	Rubber Pad Kit	218
FG9T5700	4532-L1	5" dia (12.7 cm) Rigid Caster	103, 221
FG9T5700	4532-L2	5" dia (12.7 cm) Swivel Caster	103, 221
FG9T5700	9T57-L1	Ladder Cart Top/Middle Shelf	103, 221
FG9T5700	9T57-L2	Light Bulb Strap	103, 221
FG9T5700	9T57-L3	Shelf with Tool Holder	103, 221
FG9T5700	9T57-L4	Shelf without Tool Holder	103, 221
FG9T5700	9T57-L5	Locking Strap	103, 221
FG9T5800	4532-L1	5" (12.7 cm) Rigid Caster	103, 221
FG9T5800	4532-L2	5" dia (12.7 cm) Swivel Caster	103, 221
FG9T5800	9T57-L1	Ladder Cart Top/Middle Shelf	103, 221
FG9T5800	9T57-L1	Cabinet Latch Kit without Lock	103, 221
FG9T5800	9T57-L2	Light Bulb Strap	103, 221
FG9T5800	9T57-L3	Shelf with Tool Holder	103, 221
FG9T5800	9T57-L4	Shelf without Tool Holder	103, 221
FG9T5800	9T57-L5	Locking Strap	103, 221
FG9T6600	9T66-L1	4" dia (10.2 cm) Caster Kit	104, 223
FG9T6600	9T66-L2	Right Upright	104, 223
FG9T6600	9T66-L3	Left Upright	104, 223
FG9T6700	9T66-L1	4" dia (10.2 cm) Caster Kit	104, 223
FG9T6700	9T66-L2	Right Upright	104, 223
FG9T6700	9T66-L3	Left Upright	104, 223
FG9T7200	3424-L6	4" diameter (10.2 cm) Swivel Caster	99
FG9T7200	6173-M1	Polyliner Holder	99
FG9T7200	9T73-L2	Top Shelf	99
FG9T7200	9T73-L3	Middle Shelf	99
FG9T7200	9T73-L4	Base	99
FG9T7200	9T73-L5	Handle	99
FG9T7200	9T73-L6	Aluminum Upright	99
FG9T7200	9T73-L9	Wheel/Axle Parts	99
FG9T7200	9T73-M4	Tool Grip Rack and Cap	99
FG9T7200	9T73-M5	Rubber Tool Grip	99
FG9T7200	9T73-M6	Handle Tool Grip Cap	99
FG9T7200	9T94-M1	8" Ballbearing Wheel Kit	99
FG9T7200	9T94-M2	Vacuum Restraint Kit	99
FG9T7300	3424-L6	4" dia (10.2 cm) Swivel Caster	98
FG9T7300	6173-M1	Polyliner Holder	98
FG9T7300	9T73-L2	Top Shelf	98
FG9T7300	9T73-L3	Middle Shelf	98
FG9T7300	9T73-L4	Base	98
FG9T7300	9T73-L5	Handle	98
FG9T7300	9T73-L6	Aluminum Upright	98
FG9T7300	9T73-L8	Folding Bag/Bucket Platform	98
FG9T7300	9T73-L9	Wheel/Axle Parts	98
FG9T7300	9T73-M4	Tool Grip Rack and Cap	98
FG9T7300	9T73-M5	Rubber Tool Grip	98
FG9T7300	9T73-M6	Handle Tool Grip Cap	98
FG9T7300	9T94-M1	8" Ballbearing Wheel Kit	98
FG9T7300	9T94-M2	Vacuum Restraint Kit	98
FG9T7400	3424-L6	4" dia (10.2 cm) Swivel Caster	98
FG9T7400	6173-M1	Polyliner Holder	98
FG9T7400	9T73-L2	Top Shelf	98
FG9T7400	9T73-L3	Middle Shelf	98
FG9T7400	9T73-L4	Base	98
FG9T7400	9T73-L5	Handle	98
FG9T7400	9T73-L6	Aluminum Upright	98
FG9T7400	9T73-L8	Folding Bag/Bucket Platform	98
FG9T7400	9T73-M4	Tool Grip Rack and Cap	98
FG9T7400	9T73-M5	Rubber Tool Grip	98
FG9T7400	9T73-M6	Handle Tool Grip Cap	98
FG9T7400	9T94-M1	8" Ballbearing Wheel Kit	98
FG9T7400	9T94-M2	Vacuum Restraint Kit	98
FG9T7500	6173-M1	Polyliner Holder	98
FG9T7500	9T73-L2	Top Shelf	98
FG9T7500	9T73-L3	Middle Shelf	98
FG9T7500	9T73-L4	Base	98
FG9T7500	9T73-L5	Handle	98
FG9T7500	9T73-L6	Aluminum Upright	98
FG9T7500	9T73-L8	Folding Bag/Bucket Platform	98
FG9T7500	9T73-M1	Quiet Wheel and Axle Parts	98
FG9T7500	9T73-M2	Lock and Key	98
FG9T7500	9T73-M4	Tool Grip Rack and Cap	98
FG9T7500	9T73-M5	Rubber Tool Grip	98
FG9T7500	9T73-M6	Handle Tool Grip Cap	98
FG9T7500	9T94-M1	8" Ballbearing Wheel Kit	98
FG9T7600	3424-L6	4" dia (10.2 cm) Swivel Caster	101
FG9T7600	6173-M1	Polyliner Holder	101
FG9T7600	9T73-L2	Top Shelf	101
FG9T7600	9T73-L3	Middle Shelf	101
FG9T7600	9T73-L4	Base	101
FG9T7600	9T73-L5	Handle	101
FG9T7600	9T73-L6	Aluminum Upright	101
FG9T7600	9T73-L8	Folding Bag/Bucket Platform	101
FG9T7600	9T73-L9	Wheel and Axle Parts	101
FG9T7600	9T73-M2	Lock and Key	101
FG9T7600	9T73-M5	Rubber Tool Grip	101
FG9T7600	9T73-M6	Handle Tool Grip Cap	101

Fits	Part Number	Description	Page #
FG9T7600	9T94-M1	8" Ballbearing Wheel Kit	101
FG9T7700	3424-L6	4" dia (10.2 cm) Swivel Caster	101
FG9T7700	6173-M1	Polyliner Holder	101
FG9T7700	9T73-L2	Top Shelf	101
FG9T7700	9T73-L3	Middle Shelf	101
FG9T7700	9T73-L4	Base	101
FG9T7700	9T73-L5	Handle	101
FG9T7700	9T73-L6	Aluminum Upright	101
FG9T7700	9T73-L9	Wheel and Axle Parts	101
FG9T7700	9T73-M2	Lock and Key	101
FG9T7700	9T73-M4	Tool Grip Rack and Cap	101
FG9T7700	9T73-M5	Rubber Tool Grip	101
FG9T7700	9T73-M6	Handle Tool Grip Cap	101
FG9T7700	9T94-M1	8" Ballbearing Wheel Kit	101
FG9T7800	3424-L6	4" dia (10.2 cm) Swivel Caster	101
FG9T8000	6173-M1	Polyliner Holder	101
FG9T8000	9T73-L2	Top Shelf	101
FG9T8000	9T73-L3	Middle Shelf	101
FG9T8000	9T73-L4	Base	101
FG9T8000	9T73-L5	Handle	101
FG9T8000	9T73-L6	Aluminum Upright	101
FG9T8000	9T73-L8	Folding Bag/Bucket Platform	101
FG9T8000	9T73-L9	Wheel and Axle Parts	101
FG9T8000	9T73-M2	Lock and Key	101
FG9T8000	9T73-M5	Rubber Tool Grip	101
FG9T8000	9T73-M6	Handle Tool Grip Cap	101
FG9T8000	9T94-M1	8" Ballbearing Wheel Kit	101
FG9T9000	9T73-L2	Top Shelf	99
FG9T9000	9T73-L3	Middle Shelf	99
FG9T9000	9T73-L4	Base	99
FG9T9000	9T73-L5	Handle	99
FG9T9000	9T73-L6	Aluminum Upright	99
FG9T9000	9T73-L8	Folding Bag/Bucket Platform	99
FG9T9000	9T73-M1	Quiet Wheel and Axle Parts	99
FG9T9000	9T73-M5	Rubber Tool Grip	99
FG9T9000	9T73-M6	Handle Tool Grip Cap	99
FG9T9000	9T94-M1	8" Ballbearing Wheel Kit	99
FG9T9200	9T73-L8	Folding Bag/Bucket Platform	100
FG9T9200	9T73-L9	Wheel and Axle Parts	100
FG9T9200	9T73M5	Rubber Tool Grip	100
FG9T9200	9T94-M1	8" Ballbearing Wheel Kit	100
FG9T9200	9T94-M2	Vacuum Restraint Kit	100
FG9T9400	9T73-M5	Rubber Tool Grip	101
FG9T9400	9T94-M1	8" Ballbearing Wheel Kit	101
FG9T9400	9T94-M2	Vacuum Restraint Kit	101
FG9T9500	9T73-L8	Folding Bag/Bucket Platform	101
FG9T9500	9T73-M5	Rubber Tool Grip	101
FG9T9500	9T94-M1	8" Ballbearing Wheel Kit	101
FG9T9500	9T94-M2	Vacuum Restraint Kit	101
FG9VBH100000	BP06-L1	50' Power Ext. Cord	112
FG9VBH100000	BP06-L2	Backpack Motor Assembly	112
FG9VBP060000	BP06-L1	50' Power Ext. Cord	112
FG9VBP060000	BP06-L2	Backpack Motor Assembly	112
FG9VBP100000	BP06-L1	50' Power Ext. Cord	112
FG9VBP100000	BP06-L2	Backpack Motor Assembly	112
FG9VCV120000	CV12-L2	CV Motor/Fan Assembly	115
FG9VCV160000	CV12-L2	CV Motor/Fan Assembly	115
FG9VDVFN4400	DVPN-L2	DVAC Power Nozzle Assembly	111
FG9VDVFN4400	DVPN-L3	DVAC Bumper Kit	111
FG9VDVFN4400	DVPN-L4	DVAC Power Lower Wand Assembly	111
FG9VDVFN4400	DVPN-L5	DVAC Power Upper Wand Assembly	111
FG9VDVFN4400	DVPN-L8	DVAC Power Nozzle Wiring Harness Kit	111
FG9VDVFN4400	DVPN-L9	DVAC Power Nozzle Cover	111
FG9VDVFN4400	DVPN-M0	Power Nozzle Motor	111
FG9VDVFN4400	DVPN-M2	DVAC Power Nozzle Neck	111
FG9VDVFN4400	DVPN-M3	DVAC Power Nozzle Cable	111
FG9VDVFN4400	DVPN-M4	Power Nozzle Motor Circuit Board	111
FG9VDVFN4400	DVPN-M5	Power Nozzle Motor Cover	111
FG9VDVFN4400	DVPN-M6	Power Nozzle Base	111
FG9VDVFN4400	DVPN-M7	Power Nozzle Brush Roll	111
FG9VDVFN4400	DVPN-M8	Power Nozzle Wiper Blade	111
FG9VDVFN4400	DVPN-M9	Power Nozzle Motor Mounting Set	111
FG9VDVFN4400	DVPN-N1	Power Nozzle Rear Wheel w/Axle	111
FG9VDVFN4400	DVPN-N2	Power Nozzle Front Wheel w/Axle	111
FG9VDVFN4400	DVPN-N3	Power Nozzle Belt	111
FG9VDVFN4400	DVPN-N4	Power Nozzle Screw – Long	111
FG9VDVFN4400	DVPN-N5	DVAC Female Power Connector	111
FG9VDVFN4400	DVPN-N6	DVAC Power Nozzle Switch Kit	111
FG9VDVFN4400	DVPN-N7	DVAC Power Hose Assembly	111
FG9VDVFN4400	DVSS-L2	DVAC Suction Motor Kit	111
FG9VDVFN4400	DVSS-L3	DVAC Bag Full Lens	111
FG9VDVFN4400	DVSS-L4	DVAC Hose Coupling	111
FG9VDVFN4400	DVSS-L5	DVAC Exhaust Filter Door	111
FG9VDVFN4400	DVSS-L7	DVAC Air Grate Kit	111
FG9VDVFN4400	DVSS-L8	DVAC Bag-in-Place Spring Kit	111
FG9VDVFN4400	DVSS-L9	DVAC Door Gasket	111
FG9VDVFN4400	DVSS-M0	DVAC Floor Tool w/ Bristles	111
FG9VDVFN4400	DVSS-M1	DVAC Pig Tail Cord Assembly Kit	111

Fits	Part Number	Description	Page #
FG9VDVFN4400	DVSS-M2	DVAC Crevice Tool	111
FG9VDVFN4400	DVSS-M4	DVAC Straight Suction Switch Kit	111
FG9VDVFN4400	DVSS-M5	DVAC Nonpowered Hose Assembly	111
FG9VDVFN4400	DVSS-M7	DVAC Upholstery Tool	111
FG9VDVFN4400	DVSS-M8	DVAC Bag Full LED Board Kit	111
FG9VDVRC4400	9T73-M5	Rubber Tool Grip	111
FG9VDVSS4400	DVSS-L0	DVAC Nonpowered Lower/Upper Wand	111
FG9VDVSS4400	DVSS-L1	DVAC Straight Suction Harness Kit	111
FG9VDVSS4400	DVSS-L2	DVAC Suction Motor Kit	111
FG9VDVSS4400	DVSS-L3	DVAC Bag Full Lens	111
FG9VDVSS4400	DVSS-L4	DVAC Hose Coupling	111
FG9VDVSS4400	DVSS-L5	DVAC Exhaust Filter Door	111
FG9VDVSS4400	DVSS-L6	DVAC Straight Suction Floor Nozzle	111
FG9VDVSS4400	DVSS-L7	DVAC Air Grate Kit	111
FG9VDVSS4400	DVSS-L8	DVAC Bag-in-Place Spring Kit	111
FG9VDVSS4400	DVSS-L9	DVAC Door Gasket	111
FG9VDVSS4400	DVSS-M0	DVAC Floor Tool w/ Bristles	111
FG9VDVSS4400	DVSS-M1	DVAC Pig Tail Cord Assembly Kit	111
FG9VDVSS4400	DVSS-M2	DVAC Crevice Tool	111
FG9VDVSS4400	DVSS-M7	DVAC Upholstery Tool	111
FG9VMH120000	MH12-L1	MH Handle Assembly w/ Cord	114
FG9VMH120000	MH12-L2	MH Motor Assembly	114
FG9VMH150000	MH12-L1	MH Handle Assembly w/ Cord	114
FG9VMH150000	MH12-L2	MH Motor Assembly	114
FG9VPH120000	PH12-L1	PH Handle Assembly w/ Cord	114
FG9VPH120000	PH12-L2	PH Motor Assembly	114
FG9VPH150000	PH12-L2	PH Motor Assembly	114
FG9VPH160000	PH12-L1	PH Handle Assembly w/ Cord	105
FG9VUL120000	UL12-L1	40' Power Ext. Cord	115
FG9VUL120000	UL12-L2	UL Complete Motor Assembly	115
FG9VWD120000	WD12-L2	WD Lid/Motor Assembly	117
FG9VWD160000	WD12-L2	WD Lid/Motor Assembly	117
FG9W0000	9W00-L1	Funnel Top	196
FG9W0100	9W00-L1	Funnel Top	196
FG9W0100	9W01-L1	Dome Top	196
FG9W0200	9W00-L1	Funnel Top	196
FG9W0200	9W02-L1	POP Frame	196
FG9W0300	9W00-L1	Funnel Top	196
FG9W0400	9W04-L1	Towel Holder	196
FG9W0400	9W04-L2	Replacement Bucket	196
FG9W0400	9W04-L3	Replacement Squeegee	196
FG9W1088	3964-L6	Lock and Key	133, 147
FG9W1088	9W21-L1	Wheel Set (2 Wheels and 2 Caps)	133, 147
FG9W1088	9W21-L2	Axle Carriage	133, 147
FG9W1188	3964-L6	Lock and Key	133, 147
FG9W1188	9W21-L1	Wheel Set (2 Wheels and 2 Caps)	133, 147
FG9W1188	9W21-L2	Axle Carriage	133, 147
FG9W1500	9W15-L1	Lock and Key	147
FG9W1600	9W15-L1	Lock and Key	147
FG9W1900	3964-L6	Lock and Key	133
FG9W1900	9W21-L1	Wheel Set (2 Wheels and 2 Caps)	133
FG9W1900	9W21-L2	Axle Carriage	133
FG9W2000	3964-L6	Lock and Key	133
FG9W2000	9W21-L1	Wheel Set (2 Wheels and 2 Caps)	133
FG9W2000	9W21-L2	Axle Carriage	133
FG9W2000	Q925-L3	Conversion Kit Q920/Q925 (Specify Color)	133
FG9W2100	9W21-L1	Wheel Set (2 Wheels and 2 Caps)	133
FG9W2100	9W21-L2	Axle Carriage	133
FG9W2200	9W21-L1	Wheel Set (2 Wheels and 2 Caps)	133
FG9W2200	9W21-L2	Axle Carriage	133
FG9W2500	9W15-L1	Lock and Key	147
FG9W2700	3559-L3	BRUTE® Roll Out Axle	133
FG9W2700	9W27-L1	BRUTE® Roll Out Wheels/Push Caps	133
FG9W2700	9W27-L2	BRUTE® Roll Out Lid/Handle	133
FG9W2773	3559-L3	Brake Rollout Axle	133
FG9W2773	9W27-L1	50 gal Rollout Wheels/Push Caps	133
FG9W2773	9W27-L2	50 gal Rollout Lid/Handle	133
FG9W3000	2570-L4	Replacement Groundskeeper® Receptacle (Specify Color)	200
FG9W3000	9W31-L3	Base-Mount Base Cover	200
FG9W3100	9W31-L1	Funnel Top Cap	199
FG9W3100	9W31-L2	Base-Mount Mounting Pole	199
FG9W3100	9W31-L3	Base-Mount Cover	199
FG9W3200	9W31-L1	Funnel Top Cap	199
FG9W3200	9W32-L1	Wall Mount Bracket Plate	199
FG9W3300	9W31-L1	Funnel Top Cap	199
FG9W3400	9W34-L1	Ultra High-Capacity Domed Cap (Specify Color)	199
FG9W3400	9W34-L4	Ultra High-Capacity Snuff Ring	199
FG9W3700	9W37-L1	Infinity Square Top Retaining Ring	183
FG9W3700	9W37-L2	Infinity Square Hardware Kit	183
FG9W3800	9W43-L1	Infinity Round Retaining Ring	183
FG9W3800	9W43-L2	Infinity Round Hardware Kit	183
FG9W4300	9W43-L1	Infinity Round Retaining Ring	183
FG9W4300	9W43-L2	Infinity Round Hardware Kit	183
FG9W4400	9W43-L1	Infinity Round Retaining Ring	183
FG9W4400	9W43-L2	Infinity Round Hardware Kit	183
FG9W5000	9W50-L1	35-gal. Sq. Perforated Panel (Specify Color)	183
FG9W5000	9W50-L2	35-gal. Upright	183

Fits	Part Number	Description	Page #
FG9W5100	9W51-L1	50-gal. Square Perforated Panel (Specify Color)	183
FG9W5400	9W54-L1	32-gal. Round Perforated Panel (Specify Color)	183
FG9W5400	9W54-L2	32-gal. Upright	183
FG9W5500	9W55-L1	35-gal. Square Solid Panel (Specify Color)	183
FG9W5600	9W56-L1	50-gal. Square Solid Panel (Specify Color)	183
FG9W5600	9W56-L2	50-gal. Upright	183
FG9W5900	9W59-L1	32-gal. Round Solid Panel (Specify Color)	183
FG9W7100	9W71-L1	5" dia (12.7 cm) Caster Kit	132
FG9W7100	9W71-L2	12" dia (30.5 cm) Wheel Kit	132
FG9W7100	9W71-L3	Axle Kit	132
FG9W7100	9W71-L4	Handle Kit	132
FG9W7100	9W71-L5	Door Latch	132
FG9W7100	9W71-L6	Door with Latch	132
FG9W7100	9W71-L7	Bag Hoop Kit	132
FG9W7100	9W71-L8	Hinge Kit	132
FG9W7100	9W71-L9	Accessory Kit	132
FG9W8700	9W87-L1	Caddy Bag Straps	131
FGA17	LA17	Plastic Liner	181
FGA38	LA38	Plastic Liner	181
FGA38SD	LA38SD	Plastic Liner	181
FGA51	LA5	Plastic Liner	181
FGAOT15	355000GRAY	Plastic Liner	162
FGAOT30	LG30	Plastic Liner	162
FGAOT35	355200GRAY	Plastic Liner	161
FGAOT35	GL1842	Galvanized Liner	161
FGAOT62	L45	Plastic Liner	161
FGAOU20	L1536T	Plastic Liner	
FGAOU20	GL1536ST	Galvanized Liner	
FGAOU63	LG30	Plastic Liner	
FGATF18	L18	Plastic Liner	161
FGATF3020	LG30	Plastic Liner	
FGB1424	L24	Plastic Liner	
FGB1940	L40	Plastic Liner	
FGC1630	355000GRAY	Plastic Liner	
FGC2035	L2032	Plastic Liner	
FGC2044	L2032	Plastic Liner	
FGC2437	L2438	Plastic Liner	
FGC2446	L2438	Plastic Liner	
FGCC16	GL1536	Galvanized Liner	163, 164
FGDCR24	L40	Plastic Liner	158
FGDRR24	L2032	Plastic Liner	158
FGH2436	HP1	Plastic Liner	
FGK1824	LH1	Plastic Liner	
FGK2130	L1536ST	Plastic Liner	
FGK2433	355200GRAY	Plastic Liner	
FGK2736	L2736	Plastic Liner	
FGK2836	L2836	Plastic Liner	
FGK2936	L2836	Plastic Liner	
FGKSM32	355200GRAY	Plastic Liner	191
FGKSR12	LH12	Plastic Liner	191
FGKSR36	L40	Plastic Liner	191
FGKSR48SD	L150	Plastic Liner	191
FGL140MOD	L140	Plastic Liner	
FGL2030	LG30	Plastic Liner	
FGL2433	L150	Plastic Liner	
FGLBB2BK	LBB2BK	Plastic Liner	
FGLBB3BK	LBB3BK	Plastic Liner	
FGMH24	LMH24BK	Plastic Liner	179
FGMH32	LMH32BK	Plastic Liner	179
FGMH46	L46	Plastic Liner	179
FGMHR36	LR36	Plastic Liner	179
FGMHSQ18	LH18	Plastic Liner	179
FGQ05000	7570-L2	3" Caster w/ Metal Axle	57
FGQ05000	Q920-L7	Sieve	57
FGQ05000	Q930-L1	Lid	57
FGQ55000	Q550-L1	End Cap for 11", 18", 36", 48" Frames	50
FGQ56000	Q550-L1	End Cap for 11", 18", 36", 48" Frames	50
FGQ57000	Q570-L1	End Cap for 24" Frames	50
FGQ58000	Q550-L1	End Cap for 11", 18", 36", 48" Frames	50
FGQ59000	Q550-L1	End Cap for 11", 18", 36", 48" Frames	50
FGQ90088	7570-L2	Caster Kit for MF Bucket/Wringers	47
FGQ90088	Q920-L2	O-Ring for MF Bucket/Wringers	47
FGQ90088	Q920-L6	Bail for MF Bucket/Wringers	47
FGQ90088	Q920-L7	Sieve for MF Bucket/Wringers	47
FGQ93000	7570-L2	Caster Kit for MF Bucket/Wringers	57
FGQ93000	Q920-L2	O-Ring for MF Bucket/Wringers	57
FGQ93000	Q920-L6	Bail for MF Bucket/Wringers	57
FGQ93000	Q920-L7	Sieve for MF Bucket/Wringers	57
FGQ93000	Q930-L1	Lid for MF Finish Bucket	57
FGQ96600	Q966-L1	Pulse Caddy w/ Female Connect	49
FGQ97900	Q979-L1	Flow Back Pack Red Cap	52
FGQ97900	Q979-L2	Flow Male and Female Connect	52
FGQ98900	Q979-L1	Flow Back Pack Red Cap	52
FGQ98900	Q979-L2	Flow Male and Female Connect	52
FGR1012	GL1012	Galvanized Liner	201
FGR11	L41	Plastic Liner	
FGR12	LH12	Plastic Liner	186, 187
FGR14	LH12	Plastic Liner	190
FGR1530	LH12	Plastic Liner	164

Fits	Part Number	Description	Page #
FGR1530	GL1530	Galvanized Liner	164
FGR1536	355000GRAY	Plastic Liner	162
FGR1536	GL1536	Galvanized Liner	162
FGR1536ST	L1536ST	Plastic Liner	167
FGR1536ST	GL1536ST	Galvanized Liner	167
FGR1639	GL1639	Galvanized Liner	200
FGR18	L36SD	Plastic Liner	187
FGR1842	355200GRAY	Plastic Liner	167
FGR1842	GL1842	Galvanized Liner	167
FGR23	L1530	Plastic Liner	
FGR2416	L2416	Plastic Liner	
FGR2416	GL3616 (2)	Galvanized Liner	
FGR25	355000GRAY	Plastic Liner	
FGR32	355000GRAY	Plastic Liner	164
FGR32	GL1536	Galvanized Liner	164
FGR3418	L140	Plastic Liner	
FGR34HT	L2434	Plastic Liner	190
FGR3616	L2416	Plastic Liner	
FGR3616	GL3616 (3)	Galvanized Liner	
FGR36HT	L2434	Plastic Liner	186, 187
FGR38HT	L38	Plastic Liner	186, 187
FGR38SD	L38SD	Plastic Liner	187
FGR41	L41	Plastic Liner	186, 187
FGR4816	L2416	Plastic Liner	
FGR4816	GL130 (2), DGL130 (2)	Galvanized Liner	
FGR48HT	L48	Plastic Liner	186, 187
FGR5220	HP2	Plastic Liner	
FGR5220	355000GRAY	Plastic Liner	
FGR5220	355200GRAY	Plastic Liner	
FGR56	L2432BR	Plastic Liner	190
FGS3	L3	Plastic Liner	185
FGS55	L51	Plastic Liner	185
FGSC10	L10	Plastic Liner	157
FGSC14	L24	Plastic Liner	157
FGSC18	L40	Plastic Liner	157
FGSC22	L150	Plastic Liner	157
FGSH12	L8MOD	Plastic Liner	156
FGSIG4120	L41	Plastic Liner	
FGSIG4125	L41	Plastic Liner	
FGSIG5210	L52	Plastic Liner	
FGSIG5220	L52	Plastic Liner	
FGSM1	L51	Plastic Liner	195
FGSM3	L51	Plastic Liner	
FGSM4	L38	Plastic Liner	
FGSM5	L38	Plastic Liner	
FGSO12	L8MOD	Plastic Liner	163, 164
FGSO16	L1530	Plastic Liner	163, 164
FGSO16	GL1530	Galvanized Liner	163, 164
FGSO17	GL1536	Galvanized Liner	162
FGS08	L8	Plastic Liner	163, 164
FGSR14	LR14	Plastic Liner	157
FGSR18	LR18	Plastic Liner	157
FGST12	L12	Plastic Liner	143
FGST24	L24	Plastic Liner	143
FGST35	L35	Plastic Liner	143
FGST35	GL35	Galvanized Liner	143
FGST40	L40	Plastic Liner	143
FGST5	GL5	Galvanized Liner	143
FGST7	L7	Plastic Liner	143
FGT1424	L24	Plastic Liner	146
FGT1940	L40	Plastic Liner	146

GROW GREENER

Assess Build Implement Measure

As an industry leader, Rubbermaid Commercial Products is committed to partnering with commercial and residential end users on how to assess, build, implement, and measure their own specific recycling programs and processes—making recycling easy, cost-effective, and socially responsible from collection to disposal/recycle.

As a member of the USGBC, we are dedicated to promoting products for buildings that are environmentally responsible and create healthy places to work. We offer over 1,000 products that contribute to buildings achieving LEED Certification.

Contact your local Rubbermaid Commercial Products sales representative for more information on how your organization can become more socially responsible.

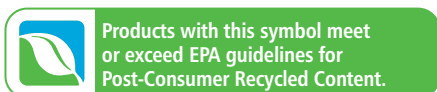

SMART DESIGN. TRUSTED EXPERIENCE.



EXECUTIVE
SERIES™



In your world, image makes all the difference. Guests expect a higher caliber of service packaged in a more unique atmosphere. Introducing a sleek new line of cleaning solutions designed to elevate your image by allowing staff to work efficiently and discreetly. Upgrade to Executive Series™ today and witness innovation in action.

Work Smarter.